

the

# Blue Press

September 2019  
\$2.95 U.S./\$3.95 Canada

## Presenting XL 750

Page 20





DP

ELLES

1 800 451 1932

# YOUR OWN AMMUNITION FACTORY...

## XL 750

- **Made in the USA**
- **RISK FREE 30-Day Trial!**
- **Lifetime "No-B.S." Warranty**
- **Automatic Indexing**
- **Uses Standard 7/8" x 14 Dies**
- **Loading Rate: 500-800 Rounds Per Hour**
- **Loads 115 Calibers**
- **Comes With One Caliber Conversion**
- **5-Station Interchangeable Toolhead**
- **Automatic Powder Measure**
- **Automatic Linear Priming System**
- **Spring-Loaded Priming Station Case Locator**
- **Integral Index Block Roller For Smoother Indexing**

# What's Inside:

**Palmetto State Armory  
PSAK47 GF3  
by Jonathan Kilburn**  
Page 10



**Gunsite Defensive Pistol Class  
by Doug Larson**  
Page 62

**Hog Heaven  
by Peter Caroline**  
Page 32



**Grand Power  
Stribog SP9A1  
by Oleg Volk**  
Page 76

# Product Index

## Dillon Precision Reloading Machines:

BL 550	40
Square Deal "B"	8
RL 550C	14
XL 750	20
SUPER 1050	30
SL 900 Shotgun Loader	44
Big Fifty Reloader .50 BMG Loader	44
RF 100 Automatic Primer Filler	17
Vibratory Case Cleaners	18
Case/Media Separators	18
Dillon Progressive Reloading Dies	34
Redding Reloading Dies	52
Dillon Reloading Scales	17
Reloading Components	38-39
Books & Videos	80-81
Eye & Ear Protection	7
Dillon Ammo Boxes & Bins	45
Dillon Leather by Mitch Rosen	24
"Plan B" Very-Bad-Day Planner Holster	24
Dillon Range Bag/Ammo Bag/Shooting Mat	35
Targets and Target Stands	59
Firearms Maintenance	64-69

**ATTENTION DILLON CUSTOMERS:** Because of changes to California's Proposition 65 that took effect on August 30, 2018, companies doing business in California are mandated to provide warnings on products that may expose Californians to any one or more of a list of approximately 900 chemicals, including Lead, which are "known to the State of California to cause cancer, birth defects or other reproductive harm." The new regulation states that a warning must be "provided in the catalog in a manner that clearly associates it with the item being purchased." Though we have no reason to believe our products could cause harm when used as intended, we now include the appropriate Proposition 65 warnings on some of our products to meet the California "safe harbor" requirements.

# We READ Our Mail!

Dear Dillon Family and Staff, I picked up off the shelf my September 2018 copy of *The Blue Press* a week ago and re-read the excellent article by Duane Thomas titled "Why Handload," which details his reasons for reloading. I want to add another reason of my own. Let's call it "reason number seven," since he provided the first six – if you include the issue of cost in the list.

Admittedly, I'm not a high-volume user and reloader of ammunition. Consequently, I probably will have very few reasons to test Dillon's great warranty. I'm lucky to get out in the field by my house on a Sunday afternoon to practice shooting for 30 minutes, given my chaotic life.

The complement to the shooting hobby is the time I can spend in front of my RL 550. I find that experience to be therapeutic and every bit as much fun as shooting. There is something at my core that loves to be productive. I set up my RL 550 in the choice of caliber, of which I find this machine extremely easy to switch over. I then can sit down and crank out 100 rounds of say, .327 Federal Magnum.

At the end of the short reloading session, set before me is a bin of 100 perfect rounds of .327. Hiccups are rare, and the weights of the powder charges are so consistent it's boring to discuss. Five minutes later, I have the machine switched back to 9mm with all its settings perfect.

A sense of satisfaction comes over me as I have manufactured my own ammunition. Well done, using well-designed, well-thought-out, high-quality Dillon equipment that works like proverbial clockwork.

Thank you, Dillon Family and Staff!

Best Regards,

David Demick – Berkshire, NY

*You're a man after my own heart, David. As much as the auto-indexing, auto-casefeeding, auto-bulletfeeding features enhance ammo-production capability, I think the simplicity of the 550 makes it one of the most attractive reloaders in the Dillon Family of Reloading Machines. It truly does complement the shooting hobby. Life can be stressful. Shooting – and reloading – is supposed to be relaxing.*



# the BLUE PRESS

Stephen M. Dillon - Publisher  
Mark G. Pixler - Editor  
mpixler@dillonprecision.com  
Gary Kieft - Technical Editor  
This Issue's Contributors:

Issue #327  
September  
2019

Peter Caroline  
Gus Cotey  
Jonathan Kilburn

Doug Larson  
Duane Thomas  
Oleg Volk

Copyright 2019 by  
Dillon Precision  
Products, Inc.

*All the electrical and/or electronic components of Dillon equipment and all Dillon textiles are covered by a one-year warranty from date of purchase. Any modifications performed to Dillon machines, or the addition of any unapproved equipment, including automated or mechanical add-ons from other manufacturers, is expressly not recommended and will void the Dillon warranty.*

We offer a smartphone app for both Apple and Android. Search "Dillon Precision" at the App Store or Google play.

*Follow the yellow brick road*

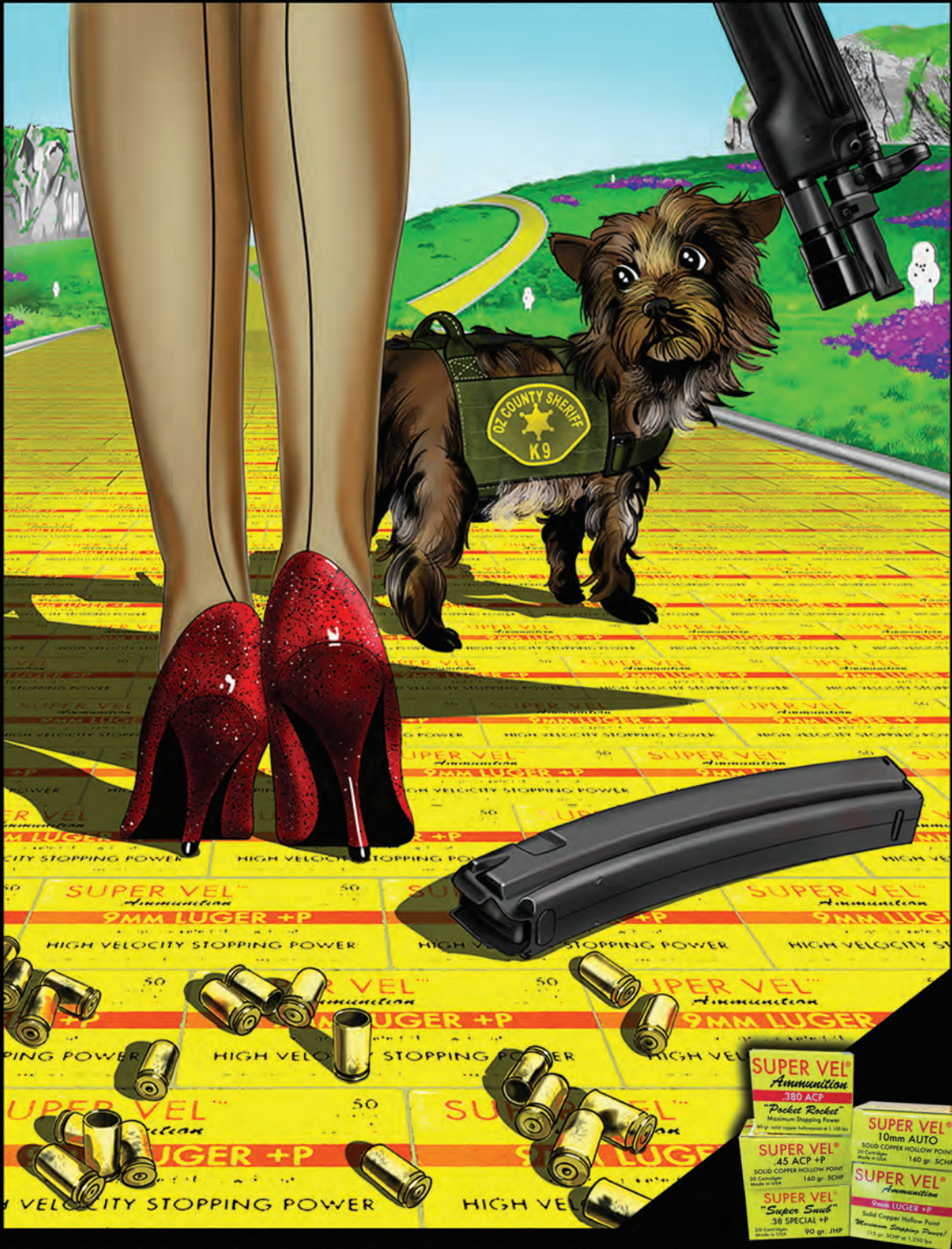

**SUPER VEL**®  
*Ammunition*

*Look for the yellow box!*

# Which Dillon is Right for YOU?



Page 8

## SQUARE DEAL B

Our automatic-indexing progressive reloader designed to load moderate quantities of common handgun calibers from .32 S&W Long to .45 Colt. It comes to you from the factory set up to load one caliber.



Page 14

## RL 550C

The World's most versatile reloader, capable of loading over 160 calibers. An automatic casefeeder is available for handgun calibers. Manual indexing and an optional magnum powder bar allow you to load magnum rifle calibers.



Page 20

## XL 750

Truly the state of the art, our XL 750 features automatic indexing, an optional automatic casefeeder and a separate station for an optional powder-level sensor. Available in all popular pistol and rifle calibers.



Page 30

## SUPER 1050

Our highest production rate reloader includes a swager to remove the crimp from military primer pockets, and is capable of reloading all the common handgun calibers and several popular rifle calibers.

## Facts and Figures

	SQUARE DEAL B	RL 550C	XL 750	SUPER 1050
<b>COST</b>				
Base price	\$436.95	\$489.95	\$649.95	\$1881.95
Caliber Conversion price range	\$93.95-103.95	\$49.95-59.95	\$81.95-91.95	\$128.95-292.95
<b>RATE</b>				
Cyclic rate (Rounds per hour)	300-500	400-600	500-800**	1000-1200
One hour production rate	350	500	800**	1000
Caliber change time	10 min	5 min	10 min	20 min
<b>FEATURES</b>				
Number of stations	4	4	5	8
Auto index	yes	no	yes	yes
Auto Casefeeder	no	optional	optional	standard
Uses standard (7/8" x 14) dies	no	yes	yes	yes
Powdercheck System	no	no	optional	optional
Primer Early Warning System	standard	standard	standard	standard
Failsafe Powder System	standard	standard	standard	standard
Separate Crimp Station	yes	yes	yes	yes
<b>SPECIFICATIONS</b>				
Primer magazine capacity	100	100	100	100
Casefeed capacity (.38/.223)	N/A	N/A	600/500	600/500
Powder measure capacity	3/4 lb	3/4 lb	3/4 lb	3/4 lb
Shipping weight	17 lbs.	25 lbs.	36 lbs.*	66 lbs.
Height required above bench***	34 in.	35 in.	44 in.	43 in.
Benchtop overhang required***	1-3/4 in.	3/4 in.	3/4 in.	None
<b>CALIBERS</b>				
Pistol	.32 S&W - .45 Colt	All common	All common	All common
Rifle	N/A	All common	All common	.223 - .30-06

\*XL 750 weighs 47 lbs. with optional Casefeeder. \*\*With optional Casefeeder. \*\*\*Without optional Strong Mount.



## Dillon's Reloading Accessory Package Deals<sup>^</sup>

include: either Dillon's D-Terminator Electronic Scale or Eliminator Balance Beam Scale, a Dial Caliper, a Primer Flip Tray, a Bench Wrench, an 8 oz. bottle of Case Lube, a pair of clear safety glasses, a machine cover and the latest edition of the Lyman *Reloading Handbook*.

SDB (Beam Scale)	P44-14482	\$209.95
SDB (Electronic Scale)	P44-14483	256.95
RL 550 (Beam Scale)	P44-21143	208.95
RL 550 (Electronic Scale)	P44-22117	256.95
XL 750 (Beam Scale)	P44-21430	223.95
XL 750 (Electronic Scale)	P44-22118	271.95

# DILLON

## HP1 Electronic Hearing Protector

- Protection Rating NRR 21
- External battery compartment
- Auto shut off extends battery life
- Extra-deep, replaceable ear pads
- Separate volume controls for each ear
- TRUE stereophonic sound
- Collapsible for ease of storage
- One-year warranty on electronics

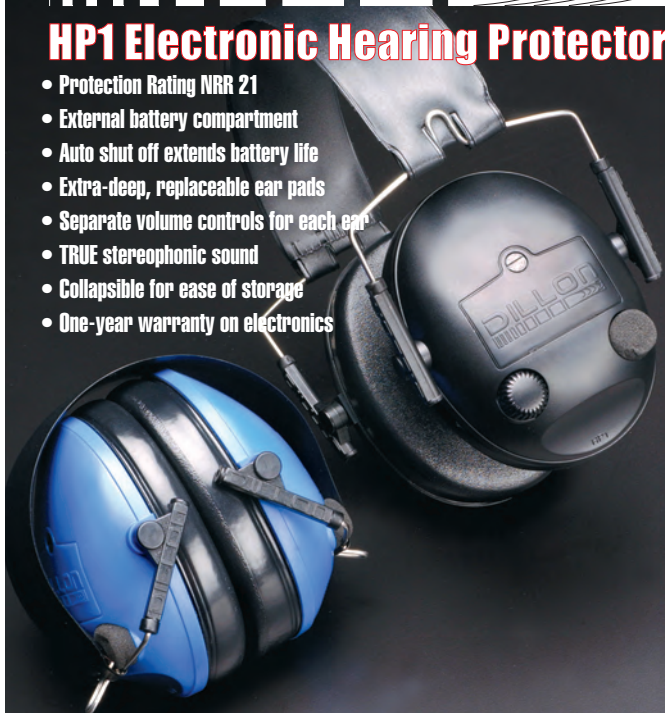

Dillon's HP1 Electronic Hearing Protector amplifies weak sounds while at the same time blocking out loud, harmful noise. During loud noises, the HP1 maintains a comfortable level of sound transmission – HP1 Hearing Protectors are designed to never completely shut off. The Dillon HP2 Folding Hearing Protector is comfortable to wear for extended periods and folds for easy storage when not in use.

## HP2 Non-Electronic Hearing Protector



## Dillon Hearing Protectors

HP1 (NRR 21) Electronic Hearing Protector, Blue <sup>^</sup>	<b>P44-10157</b>	<b>\$135.00</b>
HP1 Electronic Hearing Protector, Black <sup>^</sup>	<b>P44-10156</b>	<b>135.00</b>
HP2 (NRR 21) Non-Electronic Hearing Protector, Blue <sup>^</sup>	<b>P44-10361</b>	<b>19.95</b>
HP2 Hearing Protector, Black <sup>^</sup>	<b>P44-10360</b>	<b>19.95</b>
HP1/HP2 Replacement Ear Cushions <sup>^</sup>	<b>P44-19022</b>	<b>10.00</b>
Hearing Protector Belt Clip	<b>P44-13020</b>	<b>3.29</b>

<sup>^</sup> **WARNING:** The products offered for sale in this catalog can expose you to chemicals, including Lead, which are known to the State of California to cause cancer, birth defects or other reproductive harm. For more information, go to [www.P65Warnings.ca.gov](http://www.P65Warnings.ca.gov).

# Bomber Glasses



Bomber Glasses' lenses and frames are made from High-Index Polycarbonate that is durable, flexible and impact resistant. All colors provide UV protection.

Clear	<b>P44-10513</b>	<b>\$9.99</b>
Smoke	<b>P44-10514</b>	<b>9.99</b>
Light Blue	<b>P44-10515</b>	<b>9.99</b>
Yellow	<b>P44-10516</b>	<b>9.99</b>
Amber	<b>P44-10517</b>	<b>9.99</b>
Smoke Mirror	<b>P44-10518</b>	<b>9.99</b>

## Bifocal Shooting Glasses



### Clear, Bottom Bifocal

Clear Bifocal 1.5	<b>P44-11820</b>	<b>\$19.95</b>
Clear Bifocal 2.0	<b>P44-11821</b>	<b>19.95</b>
Clear Bifocal 2.5	<b>P44-11822</b>	<b>19.95</b>

### Smoke, Bottom Bifocal

Smoke Bifocal 1.5	<b>P44-11825</b>	<b>\$19.95</b>
Smoke Bifocal 2.0	<b>P44-11829</b>	<b>19.95</b>
Smoke Bifocal 2.5	<b>P44-11831</b>	<b>19.95</b>

## SureFire Hearing Protection



Ear Pro EP3 Sonic Defenders<sup>®</sup> by SureFire<sup>®</sup> protect you against loud, harmful noises, yet allow normal conversations to be heard; and the soft, hypoallergenic polymer provides all-day comfort. **NRR 24**

Small	<b>P44-25340</b>	<b>\$12.95</b>
Medium (Fit Most People)	<b>P44-25341</b>	<b>12.95</b>
Large	<b>P44-25342</b>	<b>12.95</b>

**Blue Press 7**

# SQUARE DEAL 'B'^

## **STANDARD FEATURES:**

- Made in the USA
- Automatic Indexing
- Available in 18 Handgun Calibers
- Loading Rate: 300-500 Rds./Hr.
- Comes With One Caliber Conversion
- Automatic Powder Measure
- Automatic Primer System
- Comes Complete With Dies
- Factory Adjusted, Ready-to-Use
- Lifetime "No-B.S." Warranty
- **RISK FREE 30-Day Trial!**

*All for ONLY...*

**\$436<sup>95\*</sup>**

## **"SDB" Stock Numbers**

.32 S&W Long/H&R Magnum*	P44-16815	\$466.95
.380 ACP	P44-20053	
.38 Special	P44-20102	
.357 Magnum	P44-20103	
.38 Super	P44-20099	
.38 Super Comp	P44-20115	
9mm	P44-20104	
.40 S&W	P44-20787	
10mm	P44-20643	
.41 Magnum	P44-20054	
.44 Special	P44-20105	
.44 Magnum	P44-20052	
.44-40 Winchester	P44-21036	
.45 ACP	P44-20101	
.45 Colt	P44-20051	
.45 GAP	P44-20098	
.45 S&W Schofield	P44-20418	

**8 Blue Press**



800-223-4570 • 480-948-8009 • bluepress.com



# SQUARE DEAL 'B' ACCESSORIES

## SQUARE DEAL 'B' CONVERSION KITS<sup>^</sup>

Change from one caliber to another in minutes. Conversion includes carbide size die (except .44-40), expander/ powder funnel, seat die, crimp die, shellplate and locator buttons.



.32 S&W Long/H&R Mag.

**P44-16774**

**\$103.95**

(.32 S&W Requires X-Small Powder Bar P44-20780 \$33.95)

.380 ACP	<b>P44-20246</b>	<b>93.95</b>
.38 Special	<b>P44-20240</b>	<b>93.95</b>
.357 Magnum	<b>P44-20240</b>	<b>93.95</b>
.38 Super	<b>P44-20229</b>	<b>93.95</b>
.38 Super Comp	<b>P44-20275</b>	<b>93.95</b>
9mm	<b>P44-20241</b>	<b>93.95</b>
.40 S&W	<b>P44-20469</b>	<b>93.95</b>
10mm	<b>P44-20469</b>	<b>93.95</b>
.41 Magnum	<b>P44-20247</b>	<b>93.95</b>
.44 Special	<b>P44-20242</b>	<b>93.95</b>
.44 Magnum	<b>P44-20242</b>	<b>93.95</b>
.44-40 Winchester	<b>P44-21035</b>	<b>93.95</b>
.45 ACP/.45 GAP	<b>P44-20123</b>	<b>93.95</b>
.45 Colt	<b>P44-20248</b>	<b>93.95</b>
.45 S&W Schofield	<b>P44-20417</b>	<b>93.95</b>

## SQUARE DEAL 'B' DELUXE QUICK CHANGE<sup>^</sup> (Not

Pictured) Includes toolhead, powder measure and SDB

Toolhead Stand.

**P44-62256 \$132.95**

'SDB' POWDER MEASURE<sup>^</sup>

**P44-20001 \$86.95**



## SQUARE DEAL 'B' TOOLHEAD<sup>^</sup>

Extra toolheads keep all your adjustments the way you left them.

**P44-20113, \$34.95**

## SQUARE DEAL 'B' TOOLHEAD STAND

Holds your SDB toolhead, powder measure, dies and caliber conversion components (not included) in an orderly manner.

**P44-62225, \$27.95**



## SQUARE DEAL 'B' BENCH WRENCH

The Square Deal Bench Wrench has the correct sizes for Square Deal "B" die adjustments.

**P44-19970, \$9.95 each.**  
**Buy two or more, \$9.10 each.**

Total price as pictured here with optional accessories: **\$653.20**

SDB Strong Mount	<b>P44-22223</b>	<b>\$68.45</b>
Low Powder Sensor	<b>P44-16306</b>	<b>\$43.95</b>
Bullet Tray	<b>P44-22214</b>	<b>\$45.95</b>
Tool Holder w/Wrench Set	<b>P44-19441</b>	<b>\$29.95</b>
Cartridge Case Bin & Bracket	<b>P44-11672</b>	<b>\$27.95</b>

**WARNING:** The products offered for sale in this catalog can expose you to chemicals, including Lead, which are known to the State of California to cause cancer, birth defects or other reproductive harm. For more information, go to [www.P65Warnings.ca.gov](http://www.P65Warnings.ca.gov).

## SQUARE DEAL "B" STRONG MOUNT & CARTRIDGE CASE BIN COMBO

Ergonomically designed to cut your workload through economy of motion! Mounts your Square Deal "B" along with a bin for your empty cartridge cases.

**P44-62395, \$78.95**

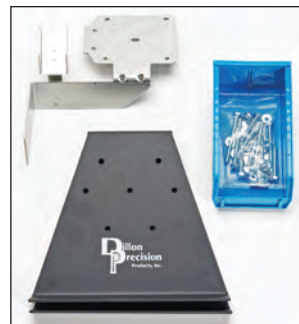

## SDB CARTRIDGE CASE BIN & BRACKET ONLY

For those who already have a Strong Mount, the blue bin and silver bracket in the above photo are available separately (hardware not included).

**P44-11672, \$27.95**



## MACHINE COVER<sup>^</sup>

This great looking nylon cover adds security to your loading bench. Your reloader will be protected against more than dust as these covers come with a D-ring that allows the heavy duty zipper to be locked.

Cover, **P44-13795, \$23.95**

Master lock,

**P44-13083, \$3.95**

## MACHINE MAINTENANCE KIT<sup>^</sup>

Everything you need to keep your Dillon loader cleaned and lubricated up to factory specifications.

Available in combination with a spare parts kit for your machine.

**Maint. Kit/SDB Spare Parts Kit**

**P44-97015, \$37.95**



## SDB SPARE PARTS KIT<sup>^</sup>

1 SD Shellplate Bolt  
1 SD Ejection Wire  
4 SD Wave Bearings  
1 Toolhead Friction Plate  
2 Pistol Decapping Pins  
1 Small Primer Seat Punch  
1 SD Slide Return Spring  
1 #10 Tinnerman Insert

1 Bellcrank Cube  
4 Locator Pins (#1, #2, #3, #4)  
1 Indexer Return Spring  
1 Large Primer Seat Punch  
1 Primer Seat Punch Spring  
2 Pickup Tube, Small, Yellow Tips  
2 Magazine Orifices, Large  
2 Pickup Tube, Large, Green Tips  
1 3/16" Index Ball  
2 Magazine Orifices, Small  
2 Retaining Clips  
1 SD Index Lever Assembly  
2 Dispensing Tips, Large  
2 Dispensing Tips, Small  
**P44-20778, \$23.95**

## PRIMER PICKUP TUBES

Used to transfer primers from flip tray to priming system.

1 Lg. **P44-22029 \$8.49**  
1 Sm. **P44-22028 8.49**  
2 Sm., 2 Lg. **P44-20056 26.95**  
4 Lg. **P44-20050 26.95**  
4 Sm. **P44-20049 26.95**

## PRIMER FLIP TRAY

A heavy, high-quality tray large enough for the Federal primer package. **P44-13606, \$22.95 ea.**





# Palmetto State Armory PSAK47 GF3

**By Jonathan Kilburn**

Let's be clear; Palmetto State Armory (PSA) is becoming a household name. Secondly, they've tried building an AK in the past and it hasn't gone over so well. So, will it be better this time?

The second generation of AKs made by Palmetto State Armory was met with mounting anticipation. However, it was a bit of disappointment and only had a brief run despite being a massive improvement from the Gen-1. The Gen-1s had cast bolt carriers and trunnions while the Gen 2 featured a forged bolt carrier and steel trunnion. In both versions meeting the 5000-round mark seemed to be a rare feat, but not impossible. Most seemed to have extractors break around 1300-2000 rounds. While they may last much longer and be an acceptable option for the American shooter, AK purists were disappointed.

## **The New:**

In comes the PSAK47 GF3. Our model was the MOEKOV version in black, with the MagPul Zhukov-S® folding stock and standard MagPul furniture. It features a hammer forged front trunnion, bolt, and carrier. This is a major upgrade from both the Gen 1 and Gen 2 versions of the PSAK47.

The receiver is stamped steel and steadily holds the 1/9.5" nitride 4150 barrel. It also has a mount adapter attached to the left side of the receiver for quick optic rail attachment. The finish is adequate and out of the box, pristine. Other than the forged parts, there are no drastic changes from its predecessor.

## **First Impressions:**

When it comes to fit and finish, it seems PSA's quality control is spot on. Each bolt appears to be well tightened, and the rivets seem to be fitted right. The furniture is also the typical MagPul design. They attach well and don't rattle.

The weight is surprising. It noticeably feels like less weight compared to a standard PSA AR chambered in 7.62x39 with a heavy barrel. The action is smooth and also lightweight with over and under receiver charging meaning the bolt is not binding up on the rails inside the receiver. The safety lever is 3 position and also operates smoothly. The reason for a 3-position safety is unknown, but might pair well with the Franklin Armory Binary Trigger in the future.

What stands out to me is the nitride barrel. Service life – even when shooting bi-metal bullets – is incredibly long. While purists might prefer chrome-lined barrels, the accuracy of the GF3 is improved with the superior barrel finish. It's finished off with a pretty standard left-hand thread canted muzzle brake and typical sight.

## **Performance:**

Typical performance was assessed with two ammunition brands and three magazine types. To  
800-223-4570 • 480-948-8009 • bluepress.com

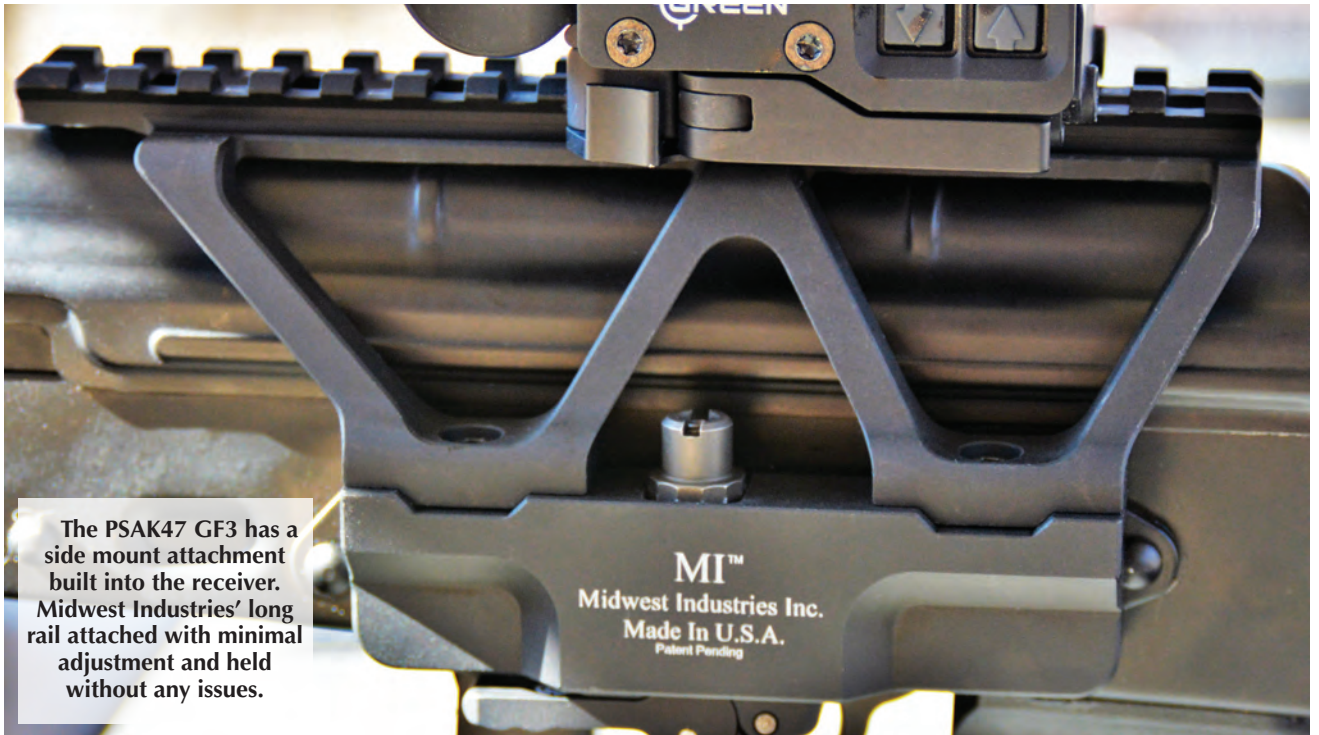

The PSAK47 GF3 has a side mount attachment built into the receiver. Midwest Industries' long rail attached with minimal adjustment and held without any issues.

start, we employed TulAmmo 122-grain FMJ and moved to Wolf WPA 124 grain. We also had the pleasure of using mixed capacity Gen 3 PMAGs, a KCI 75-round drum, and mixed capacity XTech Tactical magazines. My goal was simple: make sure the rifle could operate several different types of magazines efficiently and with moderate accuracy while utilizing varied types of ammunition. I selected these magazines for several reasons:

- MagPul ([magpul.com](http://magpul.com)) is the most common polymer magazine and relatively inexpensive. We utilized those with metal reinforcement and without.
- XTech Tactical ([xtechtactical.com](http://xtechtactical.com)) has a unique polymer magazine with a metal insert which reinforces the locking lugs and feed lips.
- The KCI Drum Magazine ([kcimags.com](http://kcimags.com)) is a completely metal construction with mixed reports of performance. However, it has been my experience that most issues with drum magazines come from end-user errors.

Magazine functionality with PMAG 10-round and 30-round magazines was flawless. The magazines were held well by the GF3. PSA has inserted a tough mag release lever, which loosened up only after a lot of time, movement and oil. While this isn't about the magazines, it seemed that MagPul was at the heart of the GS3's design.

XTech Tactical sent me both their 30-round and 10-round magazines. They fit much tighter than PMAGs, which is subjectively positive. The GF3 readily accepted the locking lugs without any hesitation. A



EO Tech's new XPS2 Green is a nice addition and offers an adequate reticle view.

quick flip of the toggle and the magazines rocked forward and out.

KCI was a different story. The mag fit tightly with some side-to-side rocking when inserted. The loose fit is not a bad thing. What it does signify is it's noisier than normal. Drum mags are noisy anyway with the rounds moving inside. Where KCI becomes slightly louder, is the steel magazine rattling against the steel receiver.



**Large Photo:** The PSAK47 GF3 looks similar to the previous two generations produced by Palmetto State Armory. However, under the good it contains a few well-placed upgrades to match the stock options available. **Inset Left:** The PSAK47 GF3 had little to no issue with any magazines the author used. This means any magazine a user wishes can be utilized by this new American AK. **Inset Right:** The author tested several MagPul magazines, KCI 75-round drum, and two types of XTech Tactical magazines. All these magazines were employed with no issues.

Loading up several magazines I headed to the range for a quick photo and actual shoot. Once there, I attached a Midwest Industries side attachment rail mount and EO Tech XPS2 Green. The Midwest Industries attached right to the side mount with minor adjustment and no clearance issues. While attached the Picatinny system is center lowered for free visual confirmation of rear and front site. While the XPS2 obscures visual confirmation of the irons, it's a great design without ever needing to remove the rail system until fieldstripping.

While the goal of this test was not to determine the accuracy of the new GF3, I was quite surprised. Forgoing the irons, a quick dial in on the XPS2 proved that the accuracy was well within industry standards at 100 yards. No functionality hiccups and movement was smooth and predictable.

Moving forward it was time to do some quick, rapid-fire bursts. The stock was folded in, KCI magazine was attached, and a strong grip was applied. Three 20-round bursts were applied in rapid succession. As the barrel heated up the oil began to smoke off. Petroleum, plastic and gunpowder filled my nostrils. No issues, no FTE and no FTF. Time to cool down.

Once the barrel returned to ambient temp, the remaining 15 rounds in the drum were fired to test for accuracy at 100 yards with no magnification while sitting at a bench. Using both TulAmmo and Wolf I was able to hit 2MOA at 100 yards while free holding. It's clear the gun can outshoot me.

### Conclusion:

PSA has done a great job on the new GF3. It's a minor upgrade from the Gen-2 and a MAJOR upgrade from the Gen-1. Some of these many European variants don't include – like the nitride barrel – while still maintaining the grizzled 'com-bloc' lines. What sets this firearm apart from the herd is the American construction mixed with pricing. With the previous experiences of many users the skepticism surrounding the GF3 is warranted. While my test was not a high-round test, we did hit over 1000 rounds without an issue. Teardown and cleaning was also straightforward. As an added bonus, the Midwest Industries mount and EO Tech XPS2 Green also performed flawlessly.

When this article was written, the GF3 cost between \$550-\$699 USD depending on the retailer. This is a significant price reduction from most foreign alternatives. Initial performance and magazine options are on par with foreign alternatives. This is an excellent, new option for the American and Canadian consumer. Personally, I am interested in witnessing how PSA does with their new GF3 in the long run.

Midwest Industries, Inc.

4498 Hillside Rd. • Waukesha, WI 53189  
262-896-6780 • [midwestindustriesinc.com](http://midwestindustriesinc.com)

Palmetto State Armory  
3760 Fernandina Rd. • Columbia, SC 29210  
803-724-6950 • [palmettostatearmory.com](http://palmettostatearmory.com)

EOTech, Inc.

1201 E. Ellsworth • Ann Arbor, MI 48108  
734-741-8868 • [eotechinc.com](http://eotechinc.com)



800-223-4570 • 480-948-8009 • [bluepress.com](http://bluepress.com)

# ERADICATES COPPER FOULING AT MAGNUM VELOCITIES.



## INTRODUCING NEW IMR ENDURON 8133.

It's the slow-burning, copper-crushing magnum powder shooters have been waiting for. Engineered for Extreme Temperature Stability, Ideal Load Density and elevated confidence and success that comes from reloading with legendary IMR powders.



# RL 550C<sup>^</sup>

## ***STANDARD FEATURES:***

- Made in the USA
- Accommodates Over 160 Calibers
- Uses Standard 7/8" x 14 Dies
- Loading Rate: 400-600 Rds./Hr.
- Comes With One Caliber Conversion
- Interchangeable Toolhead Assembly
- Automatic Powder Measure
- Automatic Primer System
- Lifetime "No-B.S." Warranty
- **RISK FREE 30-Day Trial!**

*All for ONLY...*  
**\$489<sup>95\*</sup>**

**P44-14261**

Reloading dies sold separately.  
\*Prices vary on exotic-caliber machines.

# RL 550C ACCESSORIES

## RL 550 CALIBER CONVERSION KITS<sup>▲</sup>

Contains: Shellplate, powder funnel and locator buttons. Available in all calibers; please specify caliber desired.

**P44-RL550 CONVERSION \$49.95**

(Exotic calibers, \$59.95<sup>▲</sup>)



## AUTO POWDER MEASURE SYSTEMS<sup>▲</sup>

Additional powder measures stay on the toolhead. Never change powder measurements again!

RL 550 Powder Measure

**P44-20782, \$85.95 ea.**

Magnum Rifle Powder Bar

**P44-21353, \$33.95 each**

X-Small Powder Bar

**P44-20780, \$33.95 each**

## DELUXE QUICK CHANGE ASSEMBLY<sup>▲</sup>

With a quick change assembly and a caliber conversion kit (SOLD



SEPARATELY), you can convert in less than a minute.

Complete with:

- Toolhead
- Powder Measure
- Powder Die
- Toolhead Stand

Price without Dies, **P44-22058, \$116.95**

Loading dies sold separately on Pages 34, 35 & 52.

## POWDER DIES<sup>▲</sup>

Extra powder dies allow you to move your powder measure from toolhead to toolhead without changing the "bellling" adjustment.

**P44-20064, \$13.45 each**

Three or more, \$12.45 ea.

X-Large Powder Die,

**P44-21253, \$21.95 each**



## TOOLHEADS

Don't adjust dies when switching calibers. These precision tool holders hold your dies in perfect alignment, making caliber changes quick and easy.

**P44-13909, \$26.95 each; Three or more, \$24.95 ea.**



## TOOLHEAD STANDS

The ultimate in convenience for keeping your reloading bench clean and uncluttered.

**P44-22055, \$23.95 each**

Three or more, \$21.95 ea.

Total Price as pictured with optional accessories: **\$811.10**

.45 ACP Die Set

**P44-14404 \$71.95**

Strong Mount

**P44-22051 \$52.45**

Roller Handle

**P44-17950 \$48.95**

Low Powder Sensor

**P44-16306 \$43.95**

Bullet Tray

**P44-22214 \$45.95**

Toolholder w/Wrench Set

**P44-11541 \$30.95**

Cartridge Case Bin/Bracket<sup>▲</sup>

**P44-11185 \$26.95**

**▲ WARNING:** The products offered for sale in this catalog can expose you to chemicals, including Lead, which are known to the State of California to cause cancer, birth defects or other reproductive harm. For more information, go to [www.P65Warnings.ca.gov](http://www.P65Warnings.ca.gov).

## RL 550 CASEFEEDER UPGRADE<sup>▲</sup>

Available for most pistol cartridges – will not work with rifle cartridges.

Large Pistol **P44-14450**

Small Pistol **P44-14451**

**\$294.95 (110v US Model)**

Large Pistol **P44-14453**

Small Pistol **P44-14454**

**\$304.95 (220v Euro Model)**

## CASEFEEDER CALIBER CONVERSIONS

**\$26.95 each**

.25-20/.32-20 Winchester **P44-14206**

.30 Mauser/7.62x25 **P44-14204**

.30 AAC Blackout **P44-62226**

.32 S&W Long **P44-14205**

.32 H&R Magnum **P44-14283**

9mm/9x21/.38 Super/.30 Luger **P44-14284**

10mm/9x25 Dillon **P44-14285**

.38 S&W **P44-14208**

.38 Super Comp. **P44-14287**

.38/.357 Magnum **P44-14286**

.357 SIG/.40 S&W **P44-14289**

.38-40/.44-40 Winchester **P44-14288**

.41 Magnum **P44-14290**

.44 Russian **P44-14209**

.44 Special/Magnum/Colt **P44-14291**

.45 GAP **P44-11441**

.45 ACP/.40 Super/.400 Cor-Bon **P44-14292**

.45 Auto Rim **P44-19140**

.45 Colt/.45 S&W/.454 Casull **P44-14279**

.45 Winchester Magnum **P44-14210**



## EQUIPMENT DUST COVERS<sup>▲</sup>

This packcloth nylon machine cover comes equipped with a D-ring, allowing the heavy duty zipper to be locked.

RL 550 Cover, **P44-13795, \$23.95**

Master lock, **P44-13083, \$3.95**

Quick-Change Cover<sup>▲</sup> (for use **with** powder measure)

**P44-11143, \$14.95**

## 1" BENCH WRENCH

**P44-10842, \$8.95 each**

Two or more, \$8.10 ea.



## RL 550 MACHINE MAINTENANCE KIT<sup>▲</sup>

Everything you need to keep your Dillon loader cleaned and lubricated up to factory specifications. Available in combination with a spare parts kit for your machine.

**Maint. Kit & Spare Parts Kit P44-97016, \$34.95**

## 550 SPARE PARTS KIT<sup>▲</sup>

- 1 Seating Punch, Small
- 1 #10 Tinnerman Insert
- 1 Primer Cup, Large
- 1 Primer Cup, Small
- 1 Bellcrank Cube
- 1 3/8" Index Ball
- 1 550 Brass Tip Set Screw
- 1 550 Ejector Wire
- 1 Cartridge Retaining Spring
- 1 550 Slide Return Spring
- 4 Locator Pins (#1, #2, #3, #4)
- 1 Seating Punch, Large

- 1 550 Index Ball Spring
- 2 Pickup Tube, Small, Yellow Tips
- 2 Magazine Orifices, Large
- 1 Toolhead Pin
- 2 Pickup Tube, Large, Green Tips
- 2 Magazine Orifices, Small
- 1 550 Primer Cup Spring
- 2 Retaining Clips
- 2 Dispensing Tip, Large
- 2 Dispensing Tip, Small
- 1 Failsafe Bushing Rev. B

**P44-20048, \$20.95**

## UNIVERSAL MOUNTING HARDWARE KIT

Includes: 4-Grade 5 Hex Bolts, 4-Lock Nuts, 4 Flat Washers, 4-Fender Washers, 2-Wood Screws.

**P44-14355, \$6.49**

# Dillon Reloading Accessories

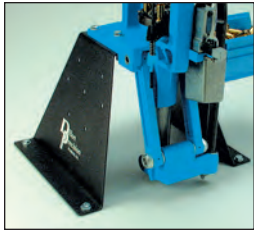

**A Strong Mount** increases your machine's "footprint" to over 10", spreading the load over the whole bench instead of stressing the leading edge. For XL 650 owners with limited overhead clearance, the XL 650-only mount raises the machine 6" above the bench top. All mounts come with

all the fasteners necessary to mount your machine and are coated with a durable black wrinkle finish.

RL 550/XL 650/750	<b>P44-22051</b>	<b>\$52.45</b>
XL 650/750-only	<b>P44-22052</b>	<b>49.45</b>
"SDB"	<b>P44-22223</b>	<b>68.45</b>

**Our Bullet Tray** is a simple, shallow aluminum tray designed and located for economy of motion. Our tray works on the Square Deal "B", RL 550 and XL 650/750 when equipped with the RL 550/650/750 Strong Mount, and a separate kit is available for the RL/Super 1050.



Bullet Tray Kit	<b>P44-22214</b>	<b>\$45.95</b>
1050 Tray Kit	<b>P44-22215</b>	<b>45.95</b>



**The Low Powder Sensor** provides an audible and visual reminder when it's time to refill your powder reservoir. When the powder level drops to about 1,000 grains remaining in the reservoir, a buzzer will sound and a bright red LED will light. Designed to fit all Dillon powder measures. Made of clear polycarbonate, it simply replaces the die-cast metal lid supplied with the measure, and operates on two AAA batteries (included).

	<b>P44-16306</b>	<b>\$43.95</b>
--	------------------	----------------

**Our Toolholders** are available for your reloading machine and ensure that the tools you need to service your reloader are handy and organized. No more digging around your bench trying to find the right size hex wrench!



XL 650/750 with Wrench Set	<b>P44-11555</b>	<b>\$32.95</b>
XL 650/750 w/o Wrench Set	<b>P44-11554</b>	<b>20.95</b>
RL 550 with Wrench Set	<b>P44-11541</b>	<b>30.95</b>
RL 550 w/o Wrench Set	<b>P44-11543</b>	<b>19.95</b>
SDB with Wrench Set	<b>P44-19441</b>	<b>29.95</b>

*Note: Super 1050 Toolholders include Wrench Set*

1050 with bracket	<b>P44-62202</b>	<b>36.95</b>
1050 w/o bracket	<b>P44-62203</b>	<b>31.95</b>
Ball-End Hex Wrenches	<b>P44-11483</b>	<b>18.95</b>
One-Inch Bench Wrench	<b>P44-10842</b>	<b>8.95</b>
SDB-Only Wrench	<b>P44-19970</b>	<b>9.95</b>



**Color Coded Aluminum Toolheads** for the RL 550 and XL 650/750 make it easy to tell at a glance which caliber you're set up to load.

Blue RL 550	<b>P44-62132</b>	<b>\$30.95</b>
Black RL 550	<b>P44-62133</b>	<b>30.95</b>
Gold RL 550	<b>P44-62134</b>	<b>30.95</b>
Silver RL 550	<b>P44-62135</b>	<b>30.95</b>
Blue XL 650/750	<b>P44-62136</b>	<b>35.95</b>
Black XL 650/750	<b>P44-62137</b>	<b>35.95</b>
Gold XL 650/750	<b>P44-62138</b>	<b>35.95</b>
Silver XL 650/750	<b>P44-62139</b>	<b>35.95</b>



**The Square Deal "B" Toolhead Stand** holds your SDB toolhead, powder measure, dies and caliber conversion components (*not included*) in an orderly manner.

	<b>P44-62225</b>	<b>\$27.95</b>
--	------------------	----------------

**Our Toolhead Stands** for the RL 550 and XL 650/750 are the ultimate in convenience for keeping your reloading bench clean and uncluttered.

**P44-22055, \$23.95 each**  
**Three or more, \$21.95 ea.**



**Dillon's 1050 Toolhead Stand** is now available to store caliber quick changes for the 1050.

	<b>P44-62200, \$49.95</b>
--	---------------------------

**Equipment Dust Covers** are made of tough packcloth nylon and add security to your loading bench. Your reloader will be protected against more than dust as the machine covers come with a D-ring that allows the heavy duty zipper to be locked.



SDB/550 Cover	<b>P44-13795</b>	<b>\$23.95</b>
XL 650/750 Cover	<b>P44-10443</b>	<b>39.95</b>
1050 Cover	<b>P44-13239</b>	<b>39.95</b>
Master lock	<b>P44-13083</b>	<b>3.95</b>

Pictured: SDB/550/650/750 Quick-Change Cover (for use with powder measure)

	<b>P44-11143</b>	<b>\$14.95</b>
--	------------------	----------------

**16 Blue Press**

800-223-4570 • 480-948-8009 • bluepress.com



Our **Primer Flip Tray** is a heavy, high-quality tray large enough for the Federal primer package.

**P44-13606, \$22.95 ea.**

**Primer Pick-Up Tubes** are used to transfer primers from flip tray to priming system. Having extras pre-loaded with primers makes it easy to load a pre-determined amount of ammo without having to stop to pick up primers.

- 1 Large
- 1 Small
- 2 Small, 2 Large
- 4 Large
- 4 Small

- P44-22029 \$8.49**
- P44-22028 8.49**
- P44-20056 26.95**
- P44-20050 26.95**
- P44-20049 26.95**



Dillon's **"Belted Magnum" Powder System** features a maximum-capacity steel powder bar that can dispense more than 100 grains of extruded IMR powder. Magnum rifle cartridges can require from 70 grains to well in excess of 100 grains for a single charge. We tested this system with various extruded rifle powders and found that powder charge variations stayed within plus-or-minus three-tenths of a grain.

**P44-97126 \$158.95**

The **Powdercheck System** (available for XL 650/750 and Super 1050 reloading machines) sounds an alarm if the powder charge in a round is out of limits either high or low.

**P44-21044, \$71.95 each**  
**Three or more, \$64.95 ea.**



An **Aluminum Roller Handle** gives your reloader an entirely new "feel," reduces operator fatigue, and makes primer seating easier.

**P44-17950 \$48.95**

Dillon's **1" Bench Wrench** fits our 1" Die Lock Rings which give you more space on the toolhead.

**P44-10842, \$8.95 each**  
**Two or more, \$8.10 ea.**



Our **Machine Maintenance Kits** come with everything you need to keep your Dillon loader cleaned and lubricated up to factory specifications. Available in combination with a spare parts kit for your machine.

**Machine Maintenance Kit with:**

- SDB Spare Parts Kit **P44-97015 \$37.95**
- 550 Spare Parts Kit **P44-97016 \$34.95**
- 650 Spare Parts Kit **P44-97017 \$42.95**
- 1050 Spare Parts Kit **P44-97018 \$51.95**



## "D-TERMINATOR" Electronic Scale

- 1500 grain/100 gram capacity
- Accurate to 0.1 grain/0.01 gram
- Uses four AA batteries (included)
- Comes with its own AC adapter
- 100g scale check weight included

*NOTE: Dillon electronic scales are covered by a one-year warranty from date of purchase.*

**\$139.95**  
**P44-10483**

## "ELIMINATOR" Balance-Beam Scale



**\$89.95**  
**P44-13480**

The **RF 100 Automatic Primer Filler** eliminates the task of filling primer pick up tubes. Now you simply pour your primers from their box into the top, press the blue button and watch it run! In about two minutes the primers are inside the protective metal housing. That's about 30 rounds you can load while the RF 100 is doing your work for you! The RF 100 is available for either large or small primers, and conversion kits are available at one low price of \$52.95 each.

- Large Primer Filler **P44-97077 \$359.95**
- Small Primer Filler **P44-97111 359.95**
- Large (Euro. 220v) **P44-97112 369.95**
- Small (Euro. 220v) **P44-97113 369.95**
- Small Conversion **P44-17903 52.95**
- Large Conversion **P44-17902 52.95**
- Nylon Dust Cover<sup>^</sup> **P44-11143 14.95**



**WARNING:** The products offered for sale in this catalog can expose you to chemicals, including Lead, which are known to the State of California to cause cancer, birth defects or other reproductive harm. For more information, go to [www.P65Warnings.ca.gov](http://www.P65Warnings.ca.gov).

# Case Preparation Equipment



## Vibratory Case Cleaners Case/Media Separators



CM-2000 Case/Media Separator <sup>^</sup> P44-20675 \$78.95  
 CM-500 Case/Media Separator <sup>^</sup> P44-21045 \$47.95

### CV-2001 – The Industry Standard

Dillon's CV-2001 Vibratory Case Cleaner is one of the largest in the industry. Its 12-1/2 quart bowl capacity will allow you to polish up to 1,300 .38/.357 or 550 .30-06 cases per hour. Not only is our capacity greater than most, but our motor is also larger in horsepower, internally cooled, thermally protected, and turns on precision ball bearings. This is no "hobby" machine! The bowl and base are constructed of 7/32" thick injection molded high-strength polypropylene which is impact and abrasion resistant.

### Case/Media Separators

After we sold thousands of our famous first generation FL-2000 case cleaners, customers who had purchased them began asking us to address the problem of separating the cleaned and polished brass from the cleaning media. We knew from the beginning that the simplest method of separating would be a rotating squirrel cage, but we had to find a design we could manufacture economically. Our problem was that it had to be BIG – big enough to handle the entire load of the FL-2000 series case cleaners. The solution was an injection molded reversible part. Simple, and it works

great. Our device is large, 10" x 14", and will hold more than 1,600 .38 Special cases. It sits on a large media collection tub that measures 18" x 22". The tub keeps the mess off the floor and bench. It's fast – so fast it will remove media from 1500 rounds of .223 brass in a matter of seconds.

### Limited Work Space?

Dillon's introducing the new CV-750 heavy duty Vibratory Case Cleaner for those with limited space. This new case cleaner uses the same motor as the CV-2001 and is every bit as tough – just more compact. To accompany the CV-750, the CM-500 does the same job as the larger CM-2000 Case/Media Separator; and, like the CV-750, handles just about half the capacity of the larger unit. Although scaled down in size, these two pieces of equipment are every bit as tough as their full-sized counterparts. We used the same materials in their construction and designed them to work just as hard – and do it in a more compact area!

CV 2001 <sup>^</sup> , US 110v	P44-20493	\$191.95
CV-750 <sup>^</sup> , US 110v	P44-19455	146.95
Euro 220v CV-2001 <sup>^</sup>	P44-22047	216.95
Euro 220v CV-750 <sup>^</sup>	P44-19473	171.95

**Rapid Polish 290** is the first cartridge case finish designed specifically to bring a brilliant shine (20 percent brighter than tumbling media alone) and a protective coating to reloaded ammunition. Simply add several capfuls to the media in your tumbler and run. Rapid Polish 290 has a great residual value and stays in your tumbling media. You'll use less each time you clean your cases.



*Rapid Polish 290 contains no ammonia, so it won't weaken brass cases!*

Rapid Polish 290  
 8 oz. bottle. P44-13804 \$8.95  
 Case (20 pc.) P44-20255 135.95

Dillon's **D.C.L.** non-aerosol case lube is easy to use. Simply lay your cases out, spray lightly with one or two passes and you've done it. No mess, no guesswork. Within minutes the lubricant distributes itself around the cartridge cases and you're ready to load. Try a bottle. You'll never use a grease pad again.



8 oz. bottle P44-13733 \$11.95  
 Case (20 pc.) P44-20256 168.00

10 bottles of polish/10 of lube <sup>^</sup>	
Case (20 pc.)	P44-21375 \$152.95

## Don't Forget Polishing Media!

Crushed walnut hull polishing media quickly cleans even the dirtiest of cases and is the best solution for badly tarnished, range-pick-up brass.

15-pound bag P44-13287 \$23.95

Ground corn cob polishing media is the best there is for that final polish. Leaves your brass looking better than factory new!

10-pound bag P44-13496 \$15.95

# Rapid Trim 1500 Case Trimmer<sup>^</sup>



The RT 1500 is used just like a standard size die. The big difference is that while you are pushing the case into the die to size it, an electric motor driving a carbide cutter at 4500 RPM is trimming the case to length. Chips are drawn off through a vacuum manifold that clamps to the outside of the special size/trim die. (Vacuum cleaner and hose not included.) The RT 1500 is equipped with a quick-

disconnect power cord; and it can be used on any standard reloader, single stage or progressive.

The RT 1500 Case Trimmer **P44-62164** is **\$337.95**. (Available only in 110 volt 60 hz.) Size/trim dies are sold separately (see chart below). Replacement carbide cutting blades, **P44-13141**, are **\$20.95** each. Upper lock rings, **P44-13559**, are **\$5.99** each.

## RT 1500 & 1200B Size/Trim Die Calibers<sup>^</sup>

.204 Ruger	<b>P44-21028</b>	<b>\$65.95</b>	RT 1500 Motor Only	<b>P44-61500</b>	<b>\$306.95</b>
.222 Rem.	<b>P44-21363</b>	<b>65.95</b>	<b>RT 1500 Short Trim Dies</b>		
.223 Rem.	<b>P44-20107</b>	<b>58.95</b>	<i>NOTE: The following dies MUST be used with a Short Trim Die Toolhead.</i>		
.223 Rem. Carbide	<b>P44-19797</b>	<b>187.95</b>	.300 Blk Carbide	<b>P44-62140</b>	<b>\$187.95</b>
.220 Swift	<b>P44-21364</b>	<b>65.95</b>	6.8 SPC	<b>P44-62238</b>	<b>65.95</b>
.22-250 Rem.	<b>P44-20110</b>	<b>63.95</b>	7.62 x 39	<b>P44-62237</b>	<b>65.95</b>
.243 Win.	<b>P44-20109</b>	<b>63.95</b>	<b>Short Trim Die Toolheads</b>		
.25-06 Rem.	<b>P44-21367</b>	<b>65.95</b>	RL 550	<b>P44-62231</b>	<b>\$40.95</b>
6.5 Creedmoor	<b>P44-62290</b>	<b>65.95</b>	<i>(Includes modified vacuum manifold.)</i>		
6.5 x 55mm	<b>P44-21495</b>	<b>65.95</b>	XL 650/750	<b>P44-62112</b>	<b>36.95</b>
.270 Win.	<b>P44-20112</b>	<b>63.95</b>	RL/Super 1050 <sup>^</sup>	<b>P44-62219</b>	<b>230.95</b>
7mm Rem. Mag.	<b>P44-21366</b>	<b>65.95</b>	<i>(Blue 1050 Toolhead Stand not included.)</i>		
.30-30 Win.	<b>P44-20111</b>	<b>63.95</b>			
.300 WSM	<b>P44-21029</b>	<b>65.95</b>			
.308 Win.	<b>P44-20106</b>	<b>58.95</b>			
.308 Win. Carbide	<b>P44-62126</b>	<b>187.95</b>			
.30-06	<b>P44-20108</b>	<b>58.95</b>			
.30-06 Carbide	<b>P44-62159</b>	<b>237.95</b>			
.300 Win. Mag.	<b>P44-21370</b>	<b>65.95</b>			
.300 Wby. Mag.	<b>P44-21371</b>	<b>65.95</b>			
.303 Brit.	<b>P44-21765</b>	<b>65.95</b>			
8 x 57 Mauser	<b>P44-21502</b>	<b>65.95</b>			
.338 Win. Mag.	<b>P44-21368</b>	<b>65.95</b>			



## MILITARY BRASS?

Eliminate the "Grunt Work" with Dillon's Super Swage 600

Until now, reusing military brass, with its crimped primer pockets, has been a tedious task. The Dillon solution is a remarkably simple device that bolts to your bench and allows you to swage the primer pockets with speed and ease. The case is supported from the inside, so you won't be tearing the rims off the brass. A tool steel, hardened swage rod (easy to change from large to small primers) simply rolls the crimp away. No reaming is necessary. Our unique compound cam leverage system assures not only ease of operation, but perfect alignment with each and every round. Sound simple? It is and it works. What's more, it's inexpensive. The Super Swage 600 comes with large and small swage rods.



6.8 SPC Back-Up Rod	<b>P44-62124</b>	<b>\$21.95</b>
9mm Adaptor	<b>P44-62168</b>	<b>15.95</b>
.40 S&W Adaptor	<b>P44-62169</b>	<b>15.95</b>



## Stainless Steel Headspace Case Gages

Headspace Case Gages are essential for setting your rifle size die, and make it easy to ensure that your loaded pistol rounds will function in your firearm.

.223 Remington	<b>P44-13254</b>	<b>\$27.45</b>
.308 Winchester	<b>P44-12867</b>	<b>28.45</b>
.30-06 Springfield	<b>P44-12679</b>	<b>29.45</b>
.380 ACP	<b>P44-15160</b>	<b>16.45</b>
9mm Parabellum	<b>P44-15161</b>	<b>16.45</b>
.38 Super	<b>P44-15158</b>	<b>16.45</b>
.38 Special	<b>P44-15159</b>	<b>16.45</b>
.357 Magnum	<b>P44-15163</b>	<b>16.45</b>
.40 S&W	<b>P44-15164</b>	<b>16.45</b>
10mm	<b>P44-15162</b>	<b>16.45</b>
.44 Magnum	<b>P44-15165</b>	<b>16.45</b>
.45 ACP	<b>P44-15166</b>	<b>16.45</b>
.45 Colt	<b>P44-15167</b>	<b>16.45</b>
.45 GAP	<b>P44-12672</b>	<b>16.45</b>

**^ WARNING:** The products offered for sale in this catalog can expose you to chemicals, including Lead, which are known to the State of California to cause cancer, birth defects or other reproductive harm. For more information, go to [www.P65Warnings.ca.gov](http://www.P65Warnings.ca.gov).

# INTRODUCING XL 750<sup>^</sup>

## **STANDARD FEATURES:**

- Made in the USA
- Automatic Indexing
- Uses Standard 7/8" x 14 Dies
- Loading Rate: 500-800 Rds./Hr.
- **Loads 115 Calibers**
- Comes With One Caliber Conversion
- 5-Station Interchangeable Toolhead
- Automatic Powder Measure
- **Automatic Linear Priming System**
- **Index Block Roller for Smoother Indexing**
- **Spring-Loaded Priming Station Case Locator**
- Lifetime "No-B.S." Warranty
- **RISK FREE 30-Day Trial!**

*All for ONLY...*

**\$649<sup>95\*</sup>**

**P44-750**

Reloading dies sold separately.

\*Prices vary on exotic-caliber machines.



# 650/750 Accessories

## CALIBER CONVERSION KITS<sup>^</sup>

Include shellplate, locator buttons, powder funnel and casefeed adapter parts. Available in most calibers; please specify caliber desired. (You MAY need a different casefeed plate)

**P44-XL650 CONVERSION (Specify Caliber) \$81.95\***

\*(All belted magnums and exotic calibers, \$91.95 ea.)

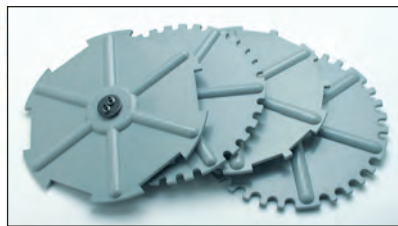

## 110/220v Variable-Speed Casefeed Assembly

Large pistol	<b>P44-21080</b>	<b>\$299.95</b>
Large rifle	<b>P44-21081</b>	<b>299.95</b>
Small pistol	<b>P44-21079</b>	<b>299.95</b>
Small rifle	<b>P44-21082</b>	<b>299.95</b>
Magnum rifle	<b>P44-21083</b>	<b>310.95</b>

## Casefeed Plate<sup>^</sup>

Large pistol	<b>P44-21072</b>	<b>\$39.95</b>
Large rifle	<b>P44-21075</b>	<b>39.95</b>
Magnum rifle	<b>P44-18492</b>	<b>50.95</b>
Small rifle	<b>P44-21074</b>	<b>39.95</b>
Small pistol	<b>P44-21073</b>	<b>39.95</b>



## POWDER MEASURE<sup>^</sup>

**P44-20782, \$85.95 each**  
Magnum Rifle Powder Bar  
**P44-21353, \$33.95 each**  
X-Small Powder Bar  
**P44-20780, \$33.95 each**

## QUICK CHANGE<sup>^</sup>

Toolhead, Toolhead Stand and Powder Measure

**P44-22059, \$120.95**

## TOOLHEADS

**P44-13863, \$32.95 each**  
Three or more, **\$30.95 ea.**

## POWDER DIES<sup>^</sup>

Extra powder dies allow you to move your powder measure from toolhead to toolhead without changing the "bellling" adjustment.

**P44-20064, \$13.45 each, three or more, \$12.45 ea.**  
X-Large Powder Dies, **P44-21253, \$21.95 each**



## TOOLHEAD STANDS

The ultimate in convenience for keeping your reloading bench clean and uncluttered.

**P44-22055, \$23.95 each**  
Three or more, **\$21.95 ea.**

## EQUIPMENT DUST COVERS<sup>^</sup>

This packcloth nylon machine cover comes equipped with a D-ring, allowing the heavy-duty zipper to be locked.

650/750 Cover, **P44-10443, \$39.95**  
(P.) Master lock, **P44-13083, \$3.95**  
Quick-Change Cover (for use with powder measure) **P44-11143, \$14.95**



## XL 750 PRIMING SYSTEM<sup>^</sup> (Not Pictured)

Priming System Assembly **P44-75100 \$74.95**

## DON'T FORGET ONE OF THESE!

Mounting Hardware Kit **P44-14355 \$6.49**  
1" Bench Wrench **P44-10842 8.95**  
Buy two or more Bench Wrenches for \$8.10 each

<b>XL 750 total price as pictured here with optional accessories: \$1318.05</b>	
Variable-Speed Electric Casefeeder	<b>P44-210** \$299.95</b>
Powdercheck System	<b>P44-21044 \$71.95</b>
.45 ACP Die Set	<b>P44-14404 \$71.95</b>
Strong Mount (550/650)	<b>P44-22051 \$52.45</b>
Roller Handle	<b>P44-17950 \$48.95</b>
Low Powder Sensor	<b>P44-16306 \$43.95</b>
Bullet Tray	<b>P44-22214 \$45.95</b>
Toolholder w/Wrench Set	<b>P44-11555 \$32.95</b>

**WARNING:** The products offered for sale in this catalog can expose you to chemicals, including Lead, which are known to the State of California to cause cancer, birth defects or other reproductive harm. For more information, go to [www.P65Warnings.ca.gov](http://www.P65Warnings.ca.gov).

## MACHINE MAINTENANCE KIT<sup>^</sup>

Everything you need to keep your Dillon loader cleaned and lubricated up to factory specifications. Available in combination with a spare parts kit for your machine.



**Maint. Kit & Spare Parts Kit P44-97017, \$42.95**



## SPARE PARTS KIT<sup>^</sup>

- 1 650 Ejector Wire
- 1 Slide Spring Pin
- 1 Index Spring
- 1 650 Index Pawl
- 1 650 Primer Cam
- 1 XL 750 Ring Indexer
- 2 Pistol Decapping Pins
- 1 650 Index Spring Revision A
- 1 #10 Tinnerman Insert
- 1 Index Arm Bowed Washer
- 1 Short Lever Spring
- 1 Bellcrank Cube
- 1 3/8" Index Ball
- 1 Powder Bar Spacer Plug
- 1 650 Brass Tip Set Screw
- 4 Locator Pins (#1, #2, #3, #4)
- 1 5/16" Index Ball
- 1 Tab/Spring Arm Spring
- 1 Case Insert Slide Spring
- 1 650 Pawl Spring
- 1 Index Ball Spring
- 2 Pickup Tube Tips, Small
- 1 650 Tool Head Pin
- 2 Pickup Tube Tips, Large
- 1 Primer Cup Spring
- 2 Retaining Clips
- 2 650 Shellplate Cap
- 1 650 Primer Support Shim
- 1 Case Insert Slide Spring Cap
- 2 Dispensing Tips, Large
- 2 Dispensing Tips, Small
- 2 SDB #10 Rod Washer
- 1 550 Primer Slide Roller
- 1 Slide Roller Post
- 1 550 Slide Return Spring
- 1 Primer Retaining Pin Spring
- 1 10-24 x 7/8" SHCS
- 1 Primer Retaining Pin
- 1 XL 750 Primer Punch, Large
- 1 XL 750 Primer Punch, Small
- 1 XL 750 Primer Cup, Large
- 1 XL 750 Primer Cup, Small
- 1 XL 750 Primer Punch Spring
- 2 Adj. CF Port Cuff Nut

**P44-75111, \$29.95**

## PRIMER PICKUP TUBES

Used to transfer primers from flip tray to priming system.

1 Lg.	<b>P44-22029</b>	<b>\$8.49</b>
1 Sm.	<b>P44-22028</b>	<b>8.49</b>
2 Sm., 2 Lg.	<b>P44-20056</b>	<b>26.95</b>
4 Lg.	<b>P44-20050</b>	<b>26.95</b>
4 Sm.	<b>P44-20049</b>	<b>26.95</b>

## PRIMER FLIP TRAY

A heavy, high-quality tray large enough for the Federal primer package. **P44-13606, \$22.95 ea.**



# Get 2



## Eric Grauffel

- 7-Time Overall IPSC Handgun World Champion
- 1 Junior World Champion title
- 191 IPSC President Medals

### 1. First gun you ever fired?

**Eric:** Ruger .22 carbine, can't remember the model.

**Nils:** Marlin .22 rifle.

### 2. What's your favorite gun?

**Eric:** CZ Shadow 2 Orange or CZ P-10 C or, I love to shoot optic guns.

**Nils:** My favorite gun is my custom .38 Super Comp open gun built by Matt McLearn.

### 3. Do you have any rituals before you shoot?

**Eric:** Not really, besides checking if all my mags are full several times.

**Nils:** When I go to a big match, I scope out all the stages, double-checking all of the targets. Not to figure out the best possible stage plan but to assure myself I can confidently find and hit all of the targets.

### 4. What's the one thing you wish you could change about the gun industry?

**Eric:** The image of gun owners and shooting competition to the general public.

**Nils:** Public perception. The firearms industry as a whole is full of genuinely good people, and 100-percent of the gun enthusiasts I know either care about competition shooting or having the ability to defend their loved ones.

### 5. Most useless thing you own?

**Eric:** Three Guinea pigs.

**Nils:** A single-stage reloader.

### 6. Favorite food?

**Eric:** Seafood.

**Nils:** A well-seared medium-rare steak.

### 7. Favorite place on Earth?

**Eric:** Several: Home; Toscana; Costa Rica; and Boracay, Philippines.

**Nils:** I haven't traveled much, but right now it's a toss-up between Arizona and Utah.

### 8. Most annoying thing about you?

**Eric:** I work too much and don't spend enough time with family.

**Nils:** I'm disorganized and my only hobby is shooting.

### 9. Craziest thing you've ever done?

**Eric:** I don't do crazy stuff. My personal

# Eric Grauffel

# Know

over-control of things does not allow me to do crazy stuff. LOL! Basically, if too risky, I am scared.

**Nils:** Tell someone I was going to become a National Champion.

## 10. Dream job?

**Eric:** Being retired, if that counts as a job.

**Nils:** What I do now. I'm a professional shooter and product developer for a handgun company named Canik.

## 11. Who has inspired you the most?

**Eric:** I can't say one person inspired me mostly. The family heritage, from my family's side, but also from my wife's side. Each person in the family has influenced me at some point.

**Nils:** Rob Leatham. The first shooting video I ever saw was "Shooter Ready" starring Rob. I thought it was the coolest thing ever.

## 12. Who would play you in a movie?

**Eric:** Tom Cruise, because I like Ethan Hunt in "Mission Impossible," but that doesn't match with the crazy part inside me.

**Nils:** Matt Smith from "Doctor Who."

## 13. If you could have a conversation with anyone from the past, who would it be?

**Eric:** My grandmother, who passed away 10 years ago.

**Nils:** John Moses Browning.

## 14. Who's in your regular crew?

**Eric:** My wife...and all my team in the store. Alice, Seb, Jean Michel. Without all of them, I couldn't do what I do today.



## Nils Jonasson

- 4-time USPSA Limited National Champion
- 4-time USPSA Single Stack National Champion
- 2-time USPSA Limited 10 National Champion
- USPSA Multigun Tactical National Champion
- IPSC US Standard National Champion
- IDPA Indoor ESP National Champion
- IDPA ESP World Champion
- IPSC Standard World Champion

**Nils:** John McLain out of Vegas and Sam Travis from Arizona.

## 15. Words to live by?

**Eric:** Being free of any obligations is the most valuable thing people can own.

**Nils:** Focus on your dreams and don't listen to all the negative people along the way. Talent only gets you so far. Hard work gets you where you want to go.



# Nils Jonasson

# Dillon Leather by Mitch Rosen!



## 5JR-DL

**\$75**

A full-length belt slide that offers all-day comfort and superior concealment for an outside-the-pants belt holster.

Beretta 92	<b>P44-18817</b>
Colt Government Model	<b>P44-18810</b>
Colt Commander	<b>P44-18811</b>
Colt Officers	<b>P44-18812</b>
GLOCK 17, 22, 31	<b>P44-18813</b>
GLOCK 19, 23, 32	<b>P44-18814</b>
GLOCK 26, 27, 33	<b>P44-18815</b>
GLOCK 20, 21	<b>P44-18816</b>
GLOCK 42	<b>P44-10034</b>
GLOCK 43	<b>P44-10035</b>
GLOCK 43X	<b>P44-11919</b>
GLOCK 48	<b>P44-11920</b>
SIG P220, P226	<b>P44-18818</b>
SIG P228, P229	<b>P44-18827</b>
SIG P320 4.7"	<b>P44-10032</b>
SIG P365	<b>P44-10033</b>
S&W M&P 9mm/.40 Auto	<b>P44-19011</b>
S&W M& Police SHIELD™	<b>P44-12241</b>
S&W 2" J-Frame Revolver	<b>P44-18820</b>
Ruger 2.25" SP-101 Revolver	<b>P44-18828</b>



## El Raton-DL

**\$50**

This pocket holster secures and properly positions a J-Frame revolver in your pocket. Will not come out when you draw. 2" J-Frame S&W Revolver **P44-18843**



## Sport EXP-DL

**\$98**

The Sport™ holster is a straight-drop design featuring a tunnel loop and rear stabilizing slot. This is an all-around holster suited to field use, "practical" competition, and some prefer it for daily carry. Slim profile, straight drop, close to the body.

S&W 4" K-Frame	<b>P44-19372</b>
S&W 4" Lugged Bbl. L-Fr.	<b>P44-19373</b>
S&W 4" Light Bbl. N-Fr.	<b>P44-19374</b>
S&W 4" Lugged Bbl. N-Fr.	<b>P44-19375</b>
S&W 5" Lugged Bbl. N-Fr.	<b>P44-19376</b>



## Best-Quality Belt-DL

**\$70**

Simply the best GUN BELT you have ever owned. Full, double-thickness leather with solid brass buckle and hardware.

1.5" Gun Belt		1.25" Gun Belt	
32" Waist	<b>P44-18859</b>	32" Waist	<b>P44-18873</b>
34" Waist	<b>P44-18860</b>	34" Waist	<b>P44-18867</b>
36" Waist	<b>P44-18861</b>	36" Waist	<b>P44-18868</b>
38" Waist	<b>P44-18862</b>	38" Waist	<b>P44-18869</b>
40" Waist	<b>P44-18863</b>	40" Waist	<b>P44-18870</b>
42" Waist	<b>P44-18864</b>	42" Waist	<b>P44-18871</b>
44" Waist	<b>P44-18865</b>	44" Waist	<b>P44-18872</b>

**24 Blue Press**

# 5.11 Tactical®



Double Duty TDU®

Trainer

Operator

The Double Duty TDU® belt is metal-detector friendly and offers two color options. Both the Trainer and Operator belts feature 6,000-pound-test buckles and heavy, reinforced stitching, therefore can be quickly converted into secure tie downs, secondary carry straps or emergency harnesses. All 5.11 tactical belts are made of strong nylon webbing and provide a stable support for carrying firearms and accessories. *According to 5.11 Tactical, belt sizes run small, so they recommend you order one size up for the best fit.*

## 5.11® Double Duty TDU Reversible 1.5" Belt

Waist Size	1.5" TDU®	
Small 28-30"	<b>P44-21599</b>	<b>\$22.95</b>
Medium 32-34"	<b>P44-21600</b>	<b>22.95</b>
Large 36-38"	<b>P44-21601</b>	<b>22.95</b>
X-Large 40-42"	<b>P44-21602</b>	<b>22.95</b>
2X-Large 44-46"	<b>P44-21603</b>	<b>25.95</b>
3X-Large 48-50"	<b>P44-21604</b>	<b>25.95</b>
4X-Large 52-54"	<b>P44-21605</b>	<b>25.95</b>

## 5.11® 1.5" Trainer Belt & 1.75" Operator Belt

Waist Size	1.5" Trainer	1.75" Operator	
Sm. 28-30"	<b>P44-21613</b>	<b>P44-21606</b>	<b>\$39.99</b>
Med. 32-34"	<b>P44-21614</b>	<b>P44-21607</b>	<b>39.99</b>
Lg. 36-38"	<b>P44-21615</b>	<b>P44-21608</b>	<b>39.99</b>
X-Lg. 40-42"	<b>P44-21626</b>	<b>P44-21609</b>	<b>39.99</b>
2X-Lg. 44-46"	<b>P44-21627</b>	<b>P44-21610</b>	<b>44.99</b>
3X-Lg. 48-50"	<b>P44-21628</b>	<b>P44-21611</b>	<b>44.99</b>
4X-Lg. 52-54"	<b>P44-21670</b>	<b>P44-21612</b>	<b>44.99</b>

# BLADE-TECH™



The Blade-Tech Ultimate Carry Belt by Nexbelt is specifically designed for those who carry a firearm daily for personal defense. The PreciseFit ratchet system allows you to quickly tighten or loosen the belt in 1/4" increments up to 6" for the perfect fit – no matter how you carry. Rest assured, this will be the most comfortable and fastest adjusting belt you will ever own. The Ultimate Carry Belt has a water-resistant backing that helps prevent moisture from penetrating the outer surface and allows for extra strength and durability. **One size – adjusts to fit all.**

Titan Black Nylon 1.5"	<b>P44-12380</b>	<b>\$49.99</b>
Titan Brown Nylon 1.5"	<b>P44-12383</b>	<b>49.99</b>
Defender Black Leather	<b>P44-12384</b>	<b>59.99</b>
Defender Brown Leather	<b>P44-12385</b>	<b>59.99</b>

## Dillon's "Plan B" Very-Bad-Day Planner Holster^

holds a handgun and a spare magazine or pepper spray, yet it fits in with business clothing and won't draw undue attention. It looks like a typical day planner, but inside there's a holster that's adaptable for either right- or left-hand draw. It fits most .380, 9mm, .40 and .45 caliber autos, including: Beretta, Colt, GLOCK, HK, Kahr, Kel-Tec, Ruger, Taurus, SIG, and Smith & Wesson. Will also hold small-frame revolvers with two- to four-inch barrels. "Plan B" Holster **P44-10252** **\$24.95**



800-223-4570 • 480-948-8009 • bluepress.com



# BLADE-TECH™

## "Signature" OWB Holster

Over the last 21 years Blade-Tech has been dedicated to perfecting the OWB holster. In collaboration with industry leading polymer experts, Blade-Tech created an incredibly strong proprietary blend of polymers, that allowed them to precision mold the "Signature OWB holster" with extreme accuracy for a perfect fit every time! Features a positive lock trigger guard, adjustable retention screws and Tek-Loc™.



Colt 1911 R/NR (rail or no rail)	<b>P44-40148</b>	<b>\$34.99</b>
CZ 75 3.75" SP01	<b>P44-10038</b>	<b>34.99</b>
GLOCK 17/22	<b>P44-40140</b>	<b>34.99</b>
GLOCK 19/23	<b>P44-40139</b>	<b>34.99</b>
GLOCK 20/21	<b>P44-40142</b>	<b>34.99</b>
GLOCK 34/35	<b>P44-40141</b>	<b>34.99</b>
SIG 4.7" P320/X5	<b>P44-10036</b>	<b>34.99</b>
S&W 4" M&P (also fits Gen2)	<b>P44-40149</b>	<b>34.99</b>
S&W 4.25" M&P 2.0	<b>P44-10037</b>	<b>34.99</b>
Springfield 5" XD/Mod 2 9/40	<b>P44-40144</b>	<b>34.99</b>
Springfield 4.5" XDM	<b>P44-40145</b>	<b>34.99</b>
Springfield 5.25" XDM	<b>P44-40146</b>	<b>34.99</b>
STI Edge	<b>P44-40147</b>	<b>34.99</b>

## Klipt IWB Holster

The Klipt Appendix "Inside the Waistband" holster is an ideal way to conceal and securely carry a small- or medium-frame auto or J-frame revolver. Your firearm locks securely into the holster with the signature Blade-Tech click.



GLOCK 42	<b>P44-43396</b>	<b>\$29.99</b>
GLOCK 43	<b>P44-43398</b>	<b>29.99</b>
Ruger LC9	<b>P44-43394</b>	<b>29.99</b>
SIG P365	<b>P44-43401</b>	<b>29.99</b>
S&W J-Frame Revolver	<b>P44-43397</b>	<b>29.99</b>
S&W M&P Shield	<b>P44-43395</b>	<b>29.99</b>
Springfield XDS	<b>P44-43393</b>	<b>29.99</b>



**BLADE-TECH Magazine Pouches**



<b>Single Mag</b>	<b>\$19.99 ea.</b>
1911	<b>P44-40150</b>
Small GLOCK	<b>P44-40151</b>
Large GLOCK	<b>P44-40152</b>
Double-Stack 9/.40	<b>P44-40153</b>
Double-Stack .45	<b>P44-40154</b>
<b>Double Mag</b>	<b>\$29.99 ea.</b>
1911	<b>P44-40155</b>
Small GLOCK	<b>P44-40156</b>
Large GLOCK	<b>P44-40157</b>
Double-Stack 9/.40	<b>P44-40158</b>
Double-Stack .45	<b>P44-40159</b>

## BLADE-TECH 1.5" Inner/Outer Hook & Loop Belt



32"	<b>P44-12242</b>	<b>\$49.99</b>
34"	<b>P44-12243</b>	<b>49.99</b>
36"	<b>P44-12245</b>	<b>49.99</b>
38"	<b>P44-12246</b>	<b>49.99</b>
40"	<b>P44-12247</b>	<b>49.99</b>
42"	<b>P44-12249</b>	<b>49.99</b>
44"	<b>P44-12251</b>	<b>49.99</b>
46"	<b>P44-12253</b>	<b>49.99</b>
48"	<b>P44-12255</b>	<b>49.99</b>



**Large Tek-Loc™ Universal Belt Clip**  
**P44-40029 \$12.99**

# Mernickle

## Conceal-Carry Performance Series

Conceal-Carry Performance Series revolver holsters can be worn strong side, appendix carry or cross draw and are fully molded. Auto holsters are strong-side only.

4-3/4" SA Colts/clones	<b>P44-11560</b>
4-5/8" Ruger Blackhawk	<b>P44-15765</b>
2" J-Frame S&W Rev.	<b>P44-15764</b>
GLOCK 17/22	<b>P44-62277</b>
GLOCK 19/23	<b>P44-62278</b>
5" 1911 (pictured)	<b>P44-62279</b>
4" 1911	<b>P44-62288</b>



**\$79.95**

This holster/mag pouch combination was designed for the Single Action Shooting Society's "Wild Bunch" category, incorporating a holster and mag pouch that look like they were made at the turn of the century, yet feature state-of-the-art speed and accuracy. The mag pouch spaces the magazines so when you grab one mag, the second isn't in your way; above the belt line so the belt doesn't interfere with the draw; and at the max depth required by the sport – and no more – so you'll get a full grip and the ability to index with your forefinger for a rapid mag well insert.



1911 Holster	<b>P44-19947</b>	<b>\$139.95</b>
Mag Pouch	<b>P44-19946</b>	<b>44.95</b>

## SAFARILAND Custom Fit, ALS Holsters

**Safariland Custom Fit 567**

**Safariland Model 6377 ALS™**



### Safariland Custom Fit 567 Holsters

The Model 567 Custom Fit holster is one of the lightest, thinnest, best fitting concealment holsters available. True to its name, it adjusts to a wide variety of popular handguns, giving each a "custom fit" in this holster.

4" K & L-Frame S&W, Ruger, and Colt Revolvers	<b>P44-19262</b>	<b>\$43.95</b>
4" N-Frame S&W Revolvers	<b>P44-19263</b>	<b>43.95</b>
5" N-Frame S&W Revolvers	<b>P44-19264</b>	<b>43.95</b>
Beretta Compact, Taurus Compact, CZ-75, Colt Commander Model	<b>P44-19265</b>	<b>43.95</b>

### Safariland Model 6377 ALS™ Holsters

The Model 6377 is a concealment version of the all new Automatic Locking System series holster. Once the weapon is holstered, it locks into place, providing an extra measure of security from the standard open-top holster.

GLOCK 17/22	<b>P44-19444</b>	<b>\$39.95</b>
SIG 220/226	<b>P44-19446</b>	<b>39.95</b>
SIG 220/226 with Accessory Rail (no light)	<b>P44-19447</b>	<b>39.95</b>
SIG 228	<b>P44-19445</b>	<b>39.95</b>
S&W M&P 9/40	<b>P44-19448</b>	<b>39.95</b>
Springfield 5" XD 9/40	<b>P44-40075</b>	<b>39.95</b>
Springfield XDM 9mm	<b>P44-40076</b>	<b>39.95</b>
Springfield XDM .40	<b>P44-40077</b>	<b>39.95</b>

**WARNING:** The products offered for sale in this catalog can expose you to chemicals, including Lead, which are known to the State of California to cause cancer, birth defects or other reproductive harm. For more information, go to [www.P65Warnings.ca.gov](http://www.P65Warnings.ca.gov).

# Comp-Tac



## Comp-Tac QB

The QB can be worn as a concealed carry or competition holster. Can be worn left or right handed, has cant adjustability and a high quality Push-Button mount that is easy on, easy off and can be locked for security by sliding the button horizontally. Mount also allows for belt-width adjustment.

**QB Size 1 fits:** GLOCK 9/.40/.357 all lengths, GLOCK 41, GLOCK 36; S&W M&P 9/.40/.357 all lengths (not Shield); Walther PPQ/M2 all lengths **P44-43380 \$49.95**

**QB Size 2 fits:** CZ P07, P09; HK VP40, P30, P30L, P30SK, USPs full size and compact, P2000; Ruger American, Ruger SR9 full size and compact; S&W M&P .45s (not Shield); Springfield XD/XDM/Mod 2 all lengths and calibers; GLOCK 20/21 all versions, GLOCK 40; SIG 250 all lengths, with and without rail, all calibers, SIG 320 all lengths, all calibers, SIG 226 all versions, SIG 229 all versions; Taurus all .45 Millennium and Millennium Pro; Walther PPQ .45 **P44-43381 \$49.95**

**QB Size 3 fits:** GLOCK 43; Springfield XD-S; S&W Shield; Walther PPS; Walther CCP **P44-43382 \$49.95**

**QB Size 4 fits:** 1911s – Colt, Kimber, Springfield including TRP Half and Full Rail, SIG 1911s, all Mil-Spec 1911s **P44-43383 \$49.95**



## IDPA Revolver Competition Holster (Above, Left)

4" K-Frame S&W Revolvers **P44-13029 \$64.99**  
 4" L-Frame S&W Revolvers **P44-13032 \$64.99**  
 2.5" N-Frame S&W Revolvers **P44-13035 \$64.99**  
 4" N-Frame S&W Revolvers **P44-13038 \$64.99**

## USPSA Revolver Competition Holster (Above, Right)

6" K-Frame S&W Revolvers **P44-13030 \$64.99**  
 6" L-Frame S&W Revolvers **P44-13033 \$64.99**  
 5" N-Frame S&W Revolvers **P44-13043 \$64.99**  
 6.5" N-Frame S&W Revolvers **P44-13044 \$64.99**



## Comp-Tac Speedloader Holders (Above, From Left)

N-Frame S&W Revolvers **P44-48968 \$32.00**  
 K/L-Frame S&W Revolvers **P44-48969 \$32.00**  
 J-Frame S&W Revolvers **P44-48967 \$32.00**

**26 Blue Press**

# SAFARILAND



## 002 "Cup Challenge" (Pictured)

6" S&W K,L,N; Std. bbl. **P44-17788 \$69.95**

## 333 "Speedloader Holder" (Pictured)

S&W K-Frame **P44-12411 \$34.95**

S&W L-Frame **P44-13087 \$34.95**

## "Competition Speedloaders" (Pictured)

S&W K-Frame **P44-13224 \$19.95**

S&W L-Frame **P44-13117 \$19.95**

## Revolver "Speedloaders"

S&W J-Frame (5-Shot) **P44-12405 \$11.95**

S&W K-Frame **P44-13104 \$11.95**

S&W L-Frame **P44-13074 \$11.95**

## "Speedloader" Holders

Sm./Med. Fr. **P44-10340 \$9.95**

## "Speedloader Loading Blocks"

S&W K-Frame **P44-12262 \$24.95**

S&W L-Frame **P44-12878 \$24.95**

# North Mountain



I've tried several methods of holding my moon clips, and the North Mountain Moon Clip Holder works best for me! My hand only has to go to one place, so I no longer grope around frantically for my reloads. – Mark Pixler

N-Frames & 7-Shot L-Frames **P44-21883 \$130.00**

## The North Mountain IDPA-Compliant Speed Loader Holder

is made specifically for the competitive IDPA revolver shooter. Lightweight at 2.9 Oz., it firmly holds your competition speed loader. It is fitted with a Tek-Lok™ to mount to your range belt. It fits Comp III and similar-sized speed loaders.

"K-Frame" **P44-21900 \$35.00**

"L-Frame" **P44-21914 \$35.00**



## Stainless EDM 8-Shot Moon Clips



These .025 EDM Stainless Moon Clips are designed to fit Remington brass SNUGLY, eliminating nasty "cartridge flop" when you reload.

**Sold in Packages of 10 for 8-Shot S&W 627 Revolvers**  
**P44-16510 \$59.95**

800-223-4570 • 480-948-8009 • bluepress.com

## California Competition Works Moon Clip Tools & Carriers

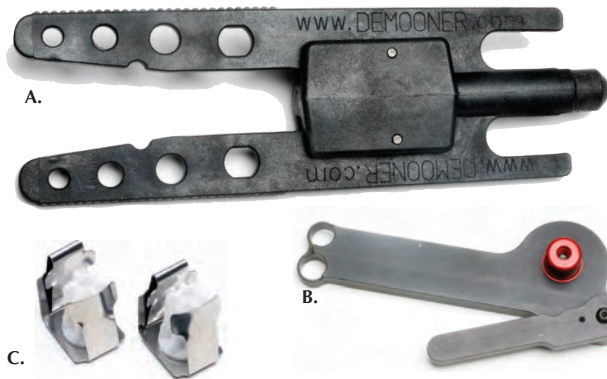

A. Demooner Tool	<b>P44-18169</b>	<b>\$16.95</b>
B. MoonLoad/Unload 8-Shot .357	<b>P44-19490</b>	<b>39.95</b>
MoonLoad/Unload 6-Shot .45	<b>P44-19489</b>	<b>39.95</b>
<i>(Works with #16510 8-shot EDM .38/.357 moon clips on Pg. 26)</i>		
.483" Repl. MoonLoad Mandrel	<b>P44-33395</b>	<b>8.00</b>
.493" Repl. MoonLoad Mandrel	<b>P44-33396</b>	<b>8.00</b>
.510" Repl. MoonLoad Mandrel	<b>P44-33397</b>	<b>8.00</b>
.530" Repl. MoonLoad Mandrel	<b>P44-33398</b>	<b>8.00</b>
.538" Repl. MoonLoad Mandrel	<b>P44-33399</b>	<b>8.00</b>
.590" Repl. MoonLoad Mandrel	<b>P44-33400</b>	<b>8.00</b>
.596" Repl. MoonLoad Mandrel	<b>P44-33401</b>	<b>8.00</b>
.620" Repl. MoonLoad Mandrel	<b>P44-33402</b>	<b>8.00</b>
.649" Repl. MoonLoad Mandrel	<b>P44-33403</b>	<b>8.00</b>
C. 6-Shot Mn. Clip Holder (2 ea.)	<b>P44-18173</b>	<b>17.90</b>
Blued .45 ACP Mn. Clips (10 ea.)	<b>P44-18183</b>	<b>9.80</b>
Stainless .45 ACP Mn. Clips (10 ea.)	<b>P44-18280</b>	<b>10.50</b>
10mm Moon Clips (10 ea.)	<b>P44-18184</b>	<b>11.20</b>
8-Shot .357 Moon Clips (10 ea.)	<b>P44-19228</b>	<b>19.95</b>

## California Competition Works .22 Speedloader

California Competition Works' 10-Round Speedloader for S&W Model 617 .22 LR Revolvers is ideal for Steel Challenge or Ruger Rimfire Series competition. The speedloaders are machined from 6061 T6 aluminum, then black anodized. The Loading Block (not pictured) is CNC machined from polymer and holds 120 rounds of .22 LR ready for insertion into speedloaders.



CCW Model 617 Speedloader	<b>P44-12623</b>	<b>\$34.95</b>
Model 617 Speedloader Handle	<b>P44-43385</b>	<b>10.00</b>
CCW .22 LR 120 Rd. Loading Block	<b>P44-12627</b>	<b>49.95</b>

## TK Custom Moon Clips



Chiappa Rhino 9mm/.40 S&W (10 Pk)	<b>P44-12040</b>	<b>\$65.00</b>
Chiappa Rhino .38/.357 (10 Pk)	<b>P44-12043</b>	<b>65.00</b>
N-Fr. 9/.38 ACP 8-Shot (Blue) (10 Pk)	<b>P44-12044</b>	<b>39.95</b>
L-Fr. 9/.38 ACP/.40 6-Shot (Blue) (10)	<b>P44-12057</b>	<b>39.95</b>
S&W N-Fr. .45 ACP 6-Shot (10 Pk)	<b>P44-12058</b>	<b>19.95</b>
S&W N-Fr. .45 ACP EDM 6-Shot (10)	<b>P44-12059</b>	<b>74.95</b>
S&W L-Fr. .38/.357 7-Shot (10 Pk)	<b>P44-12065</b>	<b>64.95</b>
S&W L-Fr. .38/.357 6-Shot (10 Pk)	<b>P44-12066</b>	<b>64.95</b>
S&W J-Fr. .38/.357 5-Shot (5 Pk)	<b>P44-12088</b>	<b>32.50</b>
S&W K-Fr. .38/.357 6-Shot (10 Pk)	<b>P44-12090</b>	<b>64.95</b>
S&W N-Fr. .38/.357 8-Shot EDM (10)	<b>P44-12091</b>	<b>64.95</b>
N-Fr. .38/.357 8-rd. EDM Starline ONLY(10)	<b>P44-12092</b>	<b>64.95</b>
S&W N-Fr. .38/.357 8-Shot (Blue) (10)	<b>P44-12093</b>	<b>39.95</b>

**WARNING:** The products offered for sale in this catalog can expose you to chemicals, including Lead, which are known to the State of California to cause cancer, birth defects or other reproductive harm. For more information, go to [www.P65Warnings.ca.gov](http://www.P65Warnings.ca.gov).

## TUFF PRODUCTS QuickSTRIPS



**TUFF QuickSTRIPS** are available for a variety of revolver calibers from .17 HM2 to .460 S&W. Sold in packages of 2.

.22 LR-Mag./17HM2-HMR (10 rd.)	<b>P44-11737</b>	<b>\$8.50</b>
.32/.327/9mm (8 rd.)	<b>P44-11738</b>	<b>8.50</b>
.38/.357/.40/10mm (5 rd.)	<b>P44-11740</b>	<b>8.50</b>
.38/.357/.40/10mm (6 rd.)	<b>P44-11741</b>	<b>8.50</b>
.38/.357/.40/10mm (7 rd.)	<b>P44-27083</b>	<b>8.50</b>
.38/.357/.40/10mm (8 rd.)	<b>P44-11742</b>	<b>8.50</b>
.44 Sp.-Mag./.45 Colt/.460 S&W/.410 Shotshell (6 rd.)	<b>P44-11750</b>	<b>8.50</b>

## SDM S&W Revolver Front Sights



<b>Pin-In Front Sight – \$28.00</b>	<b>Classic Slip-In Sight – \$35.00</b>
.250" high, red <b>P44-18379</b>	.250" high, red <b>P44-18375</b>
.250" high, green <b>P44-18380</b>	.250" high, green <b>P44-18376</b>
.300" high, red <b>P44-18381</b>	.300" high, red <b>P44-18377</b>
.300" high, green <b>P44-18382</b>	.300" high, green <b>P44-18378</b>
<b>Pin-In Front Sight – \$44.95</b>	<b>Classic Slip-In Sight – \$44.95</b>
.250" Gold Bead <b>P44-18565</b>	.250" Gold Bead <b>P44-18567</b>
.300" Gold Bead <b>P44-18566</b>	.300" Gold Bead <b>P44-18568</b>

## W.C. Wolff Co. Revolver Springs

**(Hammer/Trigger Return Springs)**

Ruger GP-100	<b>P44-11367</b>	<b>\$10.50</b>
SP-101	<b>P44-12598</b>	<b>9.50</b>
S&W J Frame	<b>P44-12189</b>	<b>9.00</b>

**(Mainspring/Rebound Springs)**

S&W K,L,N (standard)	<b>P44-15073</b>	<b>\$15.00</b>
S&W K,L,N (reduced power)	<b>P44-15072</b>	<b>15.00</b>

## Apex Tactical Specialties



**S&W J-Frame Duty/Carry Spring Kit** – Installation of this kit reduces the trigger pull weight by approximately 3 pounds from factory specifications. **P44-14309 \$25.95**

**S&W Revolver Frame-Mounted Firing Pin** – The combination of the Firing Pin and the Reduced Power Firing Pin Return Spring is designed to reduce the probability of light strikes.

**P44-21888 \$15.95**

# HOGUE®



**S&W K, L, N, X, Z Frame Round Butt Rubber Tamer Conversion Monogrip.** An extra layer of padding helps absorb recoil and adds trigger reach for those with larger hands or long fingers.

**P44-10181 \$29.95**

**Monogrips**  
**\$26.95**



**Square Butt Monogrips**  
Colt Python **P44-12138**  
K, L-Fr. Square Butt **P44-12786**  
N-Fr. Square Butt **P44-12145**  
N-Fr. Round Butt **P44-18100**  
**Round Butt Monogrips**  
Ruger SP-101 **P44-14833**  
S&W J-Fr. Round Butt **P44-12277**  
K, L-Fr. Round Butt **P44-12549**



**Jerry Miculek Competition Grips**  
**\$79.95**

N-Fr. Round Butt **P44-11324**  
N-Fr. Square Butt **P44-11325**  
K, L-Fr. Round Butt **P44-11327**  
K, L-Fr. Square Butt **P44-11326**



**"BIG Butt" Grips**  
**\$79.95**

**BIG Butt Grips**  
S&W N-Fr. Rd. Butt **P44-12141**  
K, L-Fr. Rd. Butt **P44-12140**

# ERGO Grip



The ERGO Grip Delta Grip™ is the first truly ergonomic grip for J Frame revolvers. Designed for the most important part of the gun, the shooter, the Delta Grip was engineered to fit the natural point of aim and mechanics of the human hand, wrist and arm. Fits round butt J-Frames. Will not fit on Smith and Wesson Bodyguard 38 Model.

**P44-19684 \$19.95**

**28 Blue Press**

# ODIN Ready Bag

ODIN Works introduces the new ODIN Ready Bag<sup>®</sup> (ORB)

featuring multiple pockets and pouches for mags, small gear, a clip for your keys, a water bladder pouch, and soft dividers inside to take down and pack your AR-15 while keeping parts safe and separated. For those builds with longer barrels, there is an extendable pouch at the top to ensure that any rifle will fit and be carried with ease.

Whether you're going to the range, out on a hunting trip, or just hiking through the woods, packing your gear has never been easier!

- Quick-release compression straps
- Four D-ring attachment points
- Key clip
- Loop and hook fasteners
- MOLLE fasteners
- Reinforced handles
- Two water-bottle pockets
- Ambidextrous shoulder strap
- Locking buckle
- Dividing panels that separate an AR upper and lower
- Water-bladder pouch and hole for hose
- Pocket extender: *Can remain in bag as a pocket or extend up through the zipper to fit longer barrels*
- Available in black or coyote brown
- Dimensions: 28" x 7" x 6"



ORB Black  
ORB Brown

**P43-66696 \$99.00**  
**P43-66697 99.00**

# Pachmayr Pac-Mag Gun Concealment Magnet



The Pachmayr Pac-Mag™ Holds up to 30 pounds and the three-gun magnet design gives the Pac-Mag more strength than any other gun magnet on the market. Secure almost any gun – pistol, rifle or shotgun – practically anywhere!

**P43-10098 \$19.99**

800-223-4570 • 480-948-8009 • bluepress.com

# SnapSafe Modular Vaults LOCKBOX



The SnapSafe® Modular Vaults LOCKBOX is a pry-resistant 16 gauge steel container that provides secure storage for handguns and other valuables. Meets TSA airline firearm guidelines.

Dimensions: 9.5" x 6.5" x 1.75".

**P43-01044 \$19.95**



# Sack-Ups Protective Gun Sacks



Sand Viper AR-15  
Sand Viper M24 Bolt Rifle  
Handgun, 13.5" Gray  
Handgun, 13.5" Black  
Handgun, 13.5" Natural  
Shotgun, 42" Black  
Rifle/Shotgun, 52" Gray  
Rifle/Shotgun, 52" Black  
Rifle/Shotgun, 52" Natural  
Muzzleloader, 72" Gray  
Shotgun Rcvr., 24" Gray  
Shotgun Bbl., 36" Gray

<b>P43-17378</b>	<b>\$28.99</b>
<b>P43-17348</b>	<b>28.99</b>
<b>P43-17249</b>	<b>7.99</b>
<b>P43-17250</b>	<b>7.99</b>
<b>P43-17252</b>	<b>7.99</b>
<b>P43-17253</b>	<b>10.99</b>
<b>P43-17247</b>	<b>8.99</b>
<b>P43-17248</b>	<b>10.99</b>
<b>P43-17251</b>	<b>8.99</b>
<b>P43-17254</b>	<b>11.99</b>
<b>P43-17257</b>	<b>8.99</b>
<b>P43-17256</b>	<b>8.99</b>

# HYSKORE Six-Gun Modular Pistol Rack

The HYSKORE Six Gun Modular Pistol Rack

is constructed from closed-cell, non-reactive foam that will not absorb moisture or react with lubricants or solvents. It has a soft, suede-like finish, but is rigid enough to offer firm support. The rest will hold six pistols with either single-stack or double-stack magazines, and can be disassembled and reconfigured to hold guns with wider or narrower grips.

The modular feature of the rest also means that two or more rests can be connected together and reconfigured not only to give each gun its own "special home," but also to take maximum advantage of all available space in your safe or vault. This is easy to do using 3/16" threaded rod, washers, and hex nuts available from any home-improvement store. The rack measures 11-1/4" wide x 7-1/2" deep x 6" high.



**P43-10208 \$19.99**



# Rust IS coming after your guns

These 532 gram DESI®PAK desiccants absorb moisture better than silica gel. It's an industrial grade material that exceeds the requirements of Mil Spec MIL-D-3464E. Now available in smaller packages for other applications (ammo cans, long-term storage containers, etc.).

DESI®PAK (2 bags, 1 card)

	<b>P43-21435</b>	<b>\$16.95</b>
4-ounce bag	<b>P43-14694</b>	<b>4.95</b>
2-ounce bag	<b>P43-14695</b>	<b>2.95</b>
Humidity Indicator Card, 6 pack	<b>P43-21523</b>	<b>4.95</b>

**⚠ WARNING:** The products offered for sale in this catalog can expose you to chemicals, including Lead, which are known to the State of California to cause cancer, birth defects or other reproductive harm. For more information, go to [www.P65Warnings.ca.gov](http://www.P65Warnings.ca.gov).

**Blue Press 29**

# SUPER 1050<sup>^</sup>



## **STANDARD FEATURES:**

- Made in the USA
- Loading Rate: 1000-1200 Rds/Hr
- High Strength Ductile Iron Frame
- Swages Military Primer Pockets
- Automatic Indexing
- **NEW** Variable-Speed Casefeeder
- Automatic Primer System
- Automatic Powder Measure
- Factory Adjusted Reloading Dies
- **RISK FREE 30-Day Trial!**

*All for ONLY...*

**\$1881<sup>95\*</sup>**

\*Prices vary on exotic-caliber machines.

## **SUPER 1050 Stock Numbers**

.380 ACP	P44-21135
9mm Parabellum	P44-21067
.38 Super	P44-21132
.38 Super Comp	P44-21069
.38 Special	P44-21136
.357 Magnum	P44-21137
.40 S&W	P44-21070
10mm	P44-21138
.41 Magnum	P44-21139
.44 Special	P44-21140
.44 Magnum	P44-21141
.45 ACP	P44-21061
.45 Colt	P44-21133
.223 Remington	P44-21130
.223 Rem./Carbide \$1963.95*	P44-21131
6.5 Creedmoor	P44-62404
.300 BLK/Carbide \$1953.95*	P44-62388
.308 Winchester	P44-21058
.308 Win./Carbide \$1971.95*	P44-21068

*(See Page 31 for more caliber listings.)*

# 1050 Accessories

## QUICK-CHANGE TOOLHEAD CONVERSION<sup>^</sup>

### Includes:

- Toolhead
- Powder Measure

P44-21393, \$283.95



## CALIBER CONVERSION<sup>^</sup>

### Includes:

- Shellplate
- Locator Buttons
- Swage Backup Rod/Expander
- Casefeed Adapter
- Casefeed Plunger
- Powder Funnel

### Pistol Calibers

- .32 ACP
- .32 S&W Long
- .32 H&R Magnum
- .380 ACP
- 9mm Parabellum
- .38 Super
- .38 Super Comp
- .38 Special
- .357 Magnum
- .357 SIG
- .38-40 Winchester
- .40 S&W
- 10mm
- .41 Magnum
- .44 Special
- .44 Magnum
- .44-40 Winchester
- .45 GAP
- .45 ACP
- .45 Colt
- .475 Linebaugh
- .480 Ruger
- .500 S&W Magnum

### Conversion#/Price

- #20633/\$128.95
- #20634/\$128.95
- #20634/\$128.95
- #20483/\$128.95
- #20482/\$128.95
- #20484/\$128.95
- #21057/\$128.95
- #20477/\$128.95
- #20477/\$128.95
- #20068/\$128.95
- #21160/\$128.95
- #20545/\$128.95
- #20788/\$128.95
- #20478/\$128.95
- #20479/\$128.95
- #20479/\$128.95
- #21161/\$128.95
- #21010/\$128.95
- #20480/\$128.95
- #20481/\$128.95
- #20833/\$165.95
- #20833/\$165.95
- #20834/\$165.95

### Machine#/Price

- #21162/\$1881.95
- #21134/\$1881.95
- #21134/\$1881.95
- #21135/\$1881.95
- #21067/\$1881.95
- #21132/\$1881.95
- #21069/\$1881.95
- #21136/\$1881.95
- #21137/\$1881.95
- #21127/\$1919.95\*
- #21158/\$1881.95
- #21070/\$1881.95
- #21138/\$1881.95
- #21139/\$1881.95
- #21140/\$1881.95
- #21141/\$1881.95
- #21159/\$1881.95
- #21002/\$1881.95
- #21061/\$1881.95
- #21133/\$1881.95
- call
- call
- #20428/\$1946.95\*

### Rifle Calibers

- .223 Remington
- .223 Rem./Carbide
- .22-250
- .243 Winchester
- 6.5 Creedmoor
- 6.8 SPC
- .270 Winchester
- .30 Carbine
- 7.62x39
- .300 AAC Blackout
- .30-30 Winchester
- .300 WSM
- .303 British
- .308 Winchester
- .308 Win./Carbide
- .30-06 Springfield
- .30-06 Sp./Carbide
- .45-70 Government

### Conversion#/Price

- #20485/\$128.95
- call
- #21055/\$146.95
- #21054/\$146.95
- #62403/\$146.95
- #20468/\$146.95
- #21053/\$146.95
- #20626/\$146.95
- #20631/\$165.95
- #62374/\$128.95
- #21052/\$146.95
- #20466/\$175.95
- #21051/\$146.95
- #21049/\$146.95
- call
- #21050/\$209.95
- call
- #21056/\$179.95

### Machine#/Price

- #21130/\$1881.95
- #21131/\$1963.95\*
- #21129/\$1881.95
- #21126/\$1881.95
- #62404/\$1881.95
- #21150/\$1931.95\*
- #18491/\$1881.95
- #21142/\$1898.95\*
- #21144/\$1931.95\*
- #62388/\$1953.95\*
- #21003/\$1881.95
- #21110/\$1946.95\*
- #21060/\$1881.95
- #21058/\$1881.95
- #21068/\$1971.95\*
- #21059/\$1946.95\*
- #62178/\$2104.95\*
- #21064/\$1999.95\*



## 1050 TOOLHEAD STAND

If you have more than one toolhead set up for your 1050, this is a must have to store it.

P44-62200, \$49.95

## 1050 PRIMER SYSTEM<sup>^</sup>

- Large primer system conversion
- Small primer system conversion

P44-20476 \$129.95  
P44-20419 129.95

## EXTRA CASEFEED PLATE<sup>^</sup>

- Large pistol
- Large rifle
- Small rifle
- Small pistol

P44-21072 \$39.95  
P44-21075 39.95  
P44-21074 39.95  
P44-21073 39.95

## 1050 POWDER MEASURE<sup>^</sup>

P44-20421 \$90.95  
P44-20420 \$204.95



## 1050 TOOLHOLDER

Keeps the tools you need handy and organized! Wrenches included.

With bracket P44-62202, \$36.95  
W/O bracket P44-62203, \$31.95  
Ball End Dipped Wrench Set P44-62161, \$18.95

## BULLET TRAY

Designed for "economy of motion" when loading.

P44-22215, \$45.95



## MACHINE MAINTENANCE KIT<sup>^</sup>

Everything you need to keep your Dillon loader cleaned and lubricated up to factory specifications. Available in combination with a spare parts kit.

Maint. Kit & 1050 Spare Parts Kit P44-97018, \$51.95

## MACHINE COVER<sup>^</sup>

This nylon cover adds security to your loading bench. Comes equipped with a D-ring, allowing the heavy-duty zipper to be locked.

P44-13239, \$39.95  
Master lock P44-13083, \$3.95

## SPARE PARTS KIT<sup>^</sup>

- 1 Super 1050 Spring Bushing
- 1 Cam Guide Bolt 1/4-20
- 1 Super 1050 Toolhead Spring
- 1 Priming Station Retaining Tab
- 1 Ratchet Restriction Tab
- 4 Lock Ring Inserts
- 3 Pistol Decapping Pins
- 2 #10 Tinnerman Inserts
- 1 1/4" E-Clip
- 3 Bellcrank Cubes
- 2 Primer Punch Springs
- 2 1/4-20 3/8 BH Screws

- 4 Locator Pins (#1, #2, #3, #4)
  - 1 Tab/Spring Arm Spring
  - 2 Pickup Tube Tips, Small, Yellow
  - 2 Magazine Orifices, Large, Red
  - 2 Pickup Tube Tips, Large, Green
  - 2 Magazine Orifices, Small, Blue
  - 2 Retaining Clips
  - 1 Slide Roll Pin Sleeve
  - 2 Dispensing Tips, Small
  - 2 Dispensing Tips, Large
- P44-20779, \$37.95

## PRIMER PICKUP TUBES

Used to transfer primers from flip tray to priming system.

- 1 Lg. P44-22029 \$8.49
- 1 Sm. P44-22028 8.49
- 2 Sm., 2 Lg. P44-20056 26.95
- 4 Lg. P44-20050 26.95
- 4 Sm. P44-20049 26.95



## PRIMER FLIP TRAY

A heavy, high-quality tray large enough for the Federal primer package. P44-13606, \$22.95 ea.

Total price as pictured here with optional accessories: \$2030.75

- Powdercheck System
- Low Powder Sensor
- Bullet Tray
- 1050 Toolholder

- P44-21044 \$71.95
- P44-16306 \$43.95
- P44-22215 \$45.95
- P44-62202 \$36.95

**WARNING:** The products offered for sale in this catalog can expose you to chemicals, including Lead, which are known to the State of California to cause cancer, birth defects or other reproductive harm. For more information, go to [www.P65Warnings.ca.gov](http://www.P65Warnings.ca.gov).



# Hog Heaven

By Peter Caroline

I do not lay claim to being a hunter. I have shot many prairie dogs, but that's essentially target shooting with exploding targets. On two occasions, I engaged in American bison culls on private lands. And, some years ago, I executed three feral hogs with frontal headshots at conversational distances. But that's not real hunting, which involves genuine skill and perseverance, neither of which I possess.

Several months ago, I mentioned to my friend Bill Berlat that I'd like to enjoy some real pork, the kind that was available before pork became "The Other White Meat." Real pork was tender and juicy and, yes, fatty... that's where the taste came from. We agreed that such a treat was indeed available in the wild, from feral hogs. A 200-250 lb. young sow would be ideal.

Some weeks later, Bill came up with a likely venue, the Blue Rooster Hunting Ranch in Woodruff, Arizona, which featured a large spread of open range and a mile and a half of the Little Colorado River canyon system. In addition to feral hogs, they offered big horn sheep, exotic rams and American bison. I called them up and described what I was looking for. The nice lady on the phone was quite confident they could supply the requested critter, so we set a date.

On the morning of May 15, Bill and I arrived at the ranch. He came along solely as an advisor, having hunted all over the world, and he already had a freezer full of meat. I had brought along a Skinner "Bush Pilot" Model 1892 takedown .44 Magnum carbine, which Bill had advised me would be equal to the task, along with a box of Garrett .44 Magnum 250-grain Hammerheads. I was carrying a Ruger SR1911 10mm pistol as a backup, loaded with Buffalo Bore 200-grain FMJ ammo. Bill had also recommended that I should bring

along my Ralph Bone 8" pigsticker, as a *muy macho* method of dispatching said hog. I declined in the interests of safety and sanity, and left the knife in my car.

We met our guide, an amiable young gentleman, and climbed aboard a 4-seater ATV. From the road, the ranch seemed to be located on a vast grassy plain, but as we rode along, I could see that we were approaching a canyon. As we descended a steep dirt path, I noticed an ancient petroglyph on the canyon wall, indicating previous native American habitation. I got out of the ATV and proceeded to a designated spot to wait until an appropriate target showed itself. There was, indeed, an impressive amount of porcine traffic. The first passerby was a large black boar. It was not the pig I was looking for. He gave me a contemptuous glance and ambled off into the puckerbrush.

Several minutes later, the right sow did show up. I fired, and our guide pronounced it a good shot. The pig, however, had other ideas and decided to disappear into some thick brush and trees. I followed, and after about an hour of shlepping uphill and downhill, through forest and thicket, I finally achieved a killing shot down by a stream. Now, several months earlier, I had suffered a leg injury and had undergone a month of intensive PT, without which I probably would not have been able to undertake this hunt. Anyway, our guide drove back to the ranch, picked up a trailer for the ATV and returned to load up the sow.

As it turned out, the critter weighed a bit over 200 lbs. Perfect. When it was skinned and gutted, we could find no expended bullets, even though several bones were penetrated. It would appear that, at least in this case, the Garrett Hammerheads were a bit of overkill... they went through like an icpick!

After icing and wrapping my prize in a tarp and





1.



3.



5.



2.



4.

1. Range Gate 2. PHC in woods (There's a pig in here somewhere)
3. Waiting for Miss Piggy
4. Out of the woods at last
5. PHC and Pig hanging out

loading it in the bed of my Honda Ridgeline, I took care of the financial arrangements. I was really impressed with our guide's professionalism, patience and good nature. Guiding a complete amateur (and an old, out of shape one, at that) is no easy task. Much appreciated!

Bill and I drove back to Lakeside, and dropped my prize off at the game butcher, White Mountain Meat Packing. The bed and tailgate of my truck looked like a crime scene. It'll wash off. Two mornings later, I picked

up a large cooler load of frozen and neatly labeled porcine components. So far, I've sampled only the breakfast sausage, which is lovely indeed. Life is good!

Blue Rooster Hunting Ranch  
6210 Old Woodruff Road  
Woodruff, AZ 85942 • 928-241-3221

[blueroosterranchaz@gmail.com](mailto:blueroosterranchaz@gmail.com)

White Mountain Meat Packing  
5926C Wagon Lane  
Lakeside, AZ 85929 • 928-5537-2269



Model: **K9094NC1**  
Caliber: **9MM**  
Barrel: **3.5"**, Polygonal rifling  
O/A Length: **6"**  
Height: **4.5"**  
Width: **0.9"**



**KAHR ARMS**  
WWW.KAHR.COM



Comes with a matching custom  
1791 leather holster

**500 Limited Edition**

*Kahr Arms: The First and Best Choice for Concealed Carry*



Join us: @KahrFirearms

Made in the  
**USA**

**K9**  
25th Anniversary

# Dillon Die Sets

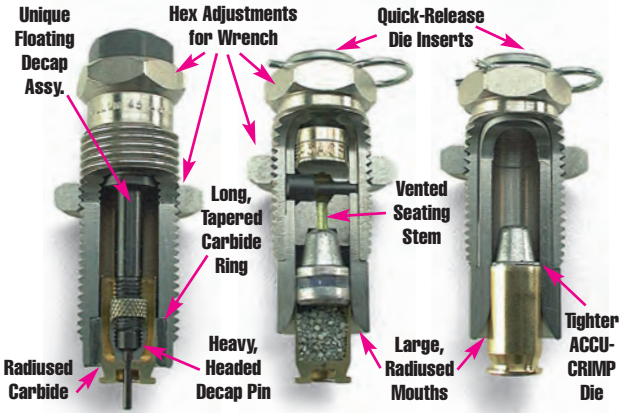

## Sizing/Depriming Die (Pistol)

Our sizing/depriming dies feature a “floating decap assembly” with a snap spring that throws the spent primer off the pin and eliminates the primer “draw back” that often occurs when decapping military brass. The primary feature of Dillon’s size die design is the long, tapered carbide ring with a radiused opening. That radiused opening, and its importance to progressive reloading, is one of the reasons why our seat and crimp dies are better. We found a way of manufacturing these dies that has enabled us to make the lead-in radius even bigger! The bigger radius makes progressive loading with our equipment even smoother – but that’s still only a part of the story.

## Bullet Seating Die (Pistol)

Our quick-disassembly seat die allows the user to disassemble and clean the seating die without losing adjustment. In this manner, bullet lube and shavings can be quickly removed from the die, thereby guaranteeing a constant seating depth. We’ve incorporated a “flip-flop” seating stem and a clip that enables you to remove the die insert and change the seating stem from round nose to semi-wadcutter without unscrewing a seating stem. Dillon’s double-ended design makes it simple to remove a pin, reverse the seating stem, make any minor seating depth adjustments that may be necessary and go on loading in a fraction of the time.

## Crimp Die (Pistol)

We’ve made it easy for you to remove the die insert for cleaning without having to change the critical crimp adjustment. Once your crimp die is set for the proper amount of crimp, you’ll never have to change it. This is especially good news for all of you who load lead bullets! Before, you had to unscrew the die from the toolhead and disassemble the die in order to remove any bullet lube or lead residue. Then, you had to start from square one to re-adjust the crimp. Those days are over. All you have to do now is pop a clip and the die insert drops into your hand for cleaning.

## Dillon Pistol Dies (Three-Die Sets)

.32 S&W Long/.32 H&R Mag.	P44-14426	\$71.95
.380 ACP	P44-14401	71.95
9mm Parabellum	P44-14406	71.95
9x25 Dillon	P44-14601	139.95
.357 SIG	P44-22083	139.95
.38 Super	P44-14399	71.95
.38 Special/.357 Magnum	P44-14400	71.95
10mm/.40 S&W	P44-14398	71.95
.41 Magnum	P44-14402	71.95
.44 Special/.44 Magnum	P44-14403	71.95
.45 ACP/.45 GAP	P44-14404	71.95
.45 Colt	P44-14405	71.95

## Spare Decapping Pins

Package of 10	P44-21528	\$6.75
---------------	-----------	--------

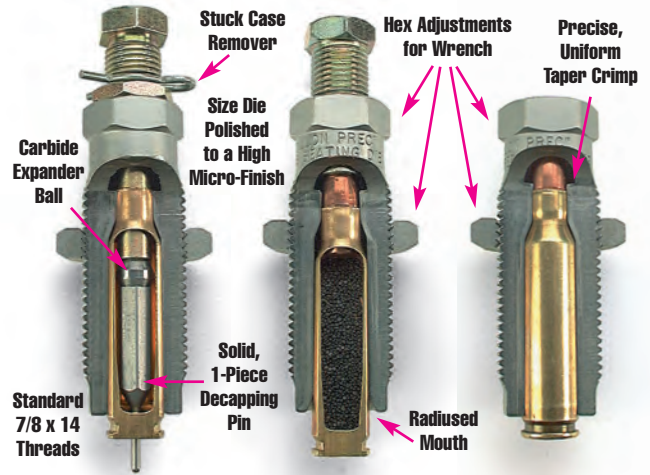

## Sizing/Depriming Die (Rifle)

The sizing/depriming die is full-length, to minimum tolerances, sizing cases down to function in semi- and full-automatic firearms. We strongly suggest that a headspace case gage be used to correctly adjust the size die.

For high volume users, such as commercial reloaders, law enforcement agencies, and high power or service rifle competitors, we also offer .223 and .308 die sets with a full-length carbide sizing die. Lubrication is still required, but the increased scratch resistance and die longevity of carbide are of great benefit to these groups of users.

The depriming assembly includes a carbide expander ball for “squeak-free,” effortless neck expansion. This expander ball is located in the middle of the depriming stem to take advantage of superior initial leverage for easier extraction.

In the event of a stuck case, the design of the depriming assembly allows it to function as a stuck case remover.

## Bullet Seating Die (Rifle)

Our bullet seating die is internally designed to keep the bullet straight throughout the seating process. Once properly adjusted, the only measurable runout will be that which is inherent in the bullet.

## Taper Crimp Die (Rifle)

The taper crimp die is also specially configured to center both the case neck and the case body, thereby aligning the entire cartridge for a more uniform crimp. Dillon Rifle Dies are designed to meet the more rigid requirements for both accuracy and precision demanded by today’s marksman.

A taper crimp die is preferred for loading ammunition intended to be used in semiautomatic firearms with detachable box magazines, and in lever-action firearms with tubular magazines.

## Dillon Rifle Dies (Three-Die Sets)

.223 Remington	P44-10839	\$80.95
.308 Winchester	P44-15574	80.95
.30-06 Springfield	P44-10840	80.95

## Dillon Carbide Rifle Dies (Three-Die Sets)

.223 Remington	P44-10096	\$176.95
.30 M1 Carbine	P44-62128	111.95
.300 AAC Blackout	P44-62114	185.95
.308 Winchester	P44-10793	182.95
.30-06 Springfield	P44-62151	288.95

## Spare Decapping Pins

.223 Remington	P44-13278	\$4.45
.308 Winchester	P44-13132	4.45
.30-06 Springfield	P44-13069	4.45
For Universal Decapping Die	P44-15816	4.45

## Spare Dillon Die Lock Rings (Fit all 7/8" x 14 thread dies)

Dillon Die Lock Ring	P44-14067	\$1.75
5-Pack Die Lock Rings	P44-10669	5.50

**Note: Individual Dillon size, seat and crimp dies are available. Call or visit our website to order.**

# Range Bag<sup>^</sup>

Dillon's Range Bag is designed to hold the Border Shift Ammo Bag (sold separately below), as well as a Dillon Large Utility Box (see Page 45). The Main Compartment is 12.5" long x 7" wide x 10" high, the End Pockets are 8.5" tall x 6.5" wide x 2" deep and the Front Pocket is 9" tall x 6" wide x 2" deep.

Range Bag, Black **P44-19366** **\$89.95**  
 Pistol Pouch, Black<sup>^</sup> **P44-17027** **10.95**



## "Border Shift" Ammo Bag<sup>^</sup>

Dillon's two-compartment ammo bag is constructed with a flexible inner liner that will allow the entire volume to be accessible from either zippered opening. You'll never again mix fired brass with loaded rounds!

Border Shift Ammo Bag, Black **P44-13755** **\$25.95**  
 I.D. Card Holder (Inset, Left)<sup>^</sup> **P44-14575** **2.95**

## Shooting Mat



Dillon's shooting mat is made of tough ballistic-weave nylon fabric, with a large skid-resistant elbow pad area. The "ground" side is moisture resistant and wipes clean easily. The padding is dense, closed-cell foam to provide both shooter comfort and a stable shooting base. The mat is equipped with a shoulder strap, a carry handle and two straps with snap-release buckles.

Dimensions: 66" x 27.75"

**P44-18146** **\$65.00**



Dillon Key Keeper, Gray **P44-96671** **\$12.99**  
 Dillon Key Keeper, Coyote **P44-96672** **12.99**  
 Dillon Key Keeper, Black **P44-96670** **12.99**

## Dillon Precision Logo PVC Key Ring



**P44-66032** **\$4.95 ea.**



6" x 1" Dillon Logo Sticker **P44-96668** **\$2.50**  
 6" x 2.5" Dillon Logo Sticker **P44-96666** **4.00**

<sup>^</sup> **WARNING:** The products offered for sale in this catalog can expose you to chemicals, including Lead, which are known to the State of California to cause cancer, birth defects or other reproductive harm. For more information, go to [www.P65Warnings.ca.gov](http://www.P65Warnings.ca.gov).

**Blue Press 35**

# "The Essentials"

## Square Deal "B" 9mm Package, P44-35004:

SDB in 9mm  
D-Terminator Digital Scale  
*The Complete Reloading Manual for the 9mm Luger*  
Digital Calipers  
Primer Flip Tray  
9mm Case Gage  
SDB Bench Wrench  
Dillon Case Preparation Guide (Not Pictured)  
Mounting Hardware Kit

**Total: \$666.20**

## Square Deal "B" Upgrade Kit, P44-35005:

SDB Strong Mount  
Bullet Tray Kit  
Empty Case Bin and Bracket

**Total: \$142.35**

## RL 550C 9mm Package, P44-35001:

RL 550C  
550 Conversion Kit, 9mm  
9mm Die Set  
D-Terminator Digital Scale  
*Lyman Reloading Manual*  
Digital Calipers  
Primer Flip Tray  
9mm Case Gage  
1" Bench Wrench  
Dillon Case Preparation Guide (Not Pictured)  
Mounting Hardware Kit

**Total: \$806.15**

## RL 550C .223/5.56 Package, P44-35003:

RL 550C  
550 Conversion Kit, .223/5.56  
Steel .223/5.56 Die Set  
D-Terminator Digital Scale  
*Lyman Reloading Manual*  
Digital Calipers  
Primer Flip Tray  
Dillon Case Lube  
.223/5.56 Case Gage  
1" Bench Wrench  
Dillon Case Preparation Guide (Not Pictured)  
Mounting Hardware Kit

**Total: \$838.10**

## RL 550C Upgrade Kit, P44-35002:

550/650/750 Strong Mount  
Bullet Tray Kit  
Empty Case Bin and Bracket  
Roller Handle

**Total: \$174.30**

## XL 750 9mm Package, P44-35009:

XL 750 in 9mm  
9mm Die Set  
D-Terminator Digital Scale  
*Lyman Reloading Manual*  
Digital Calipers  
Primer Flip Tray  
9mm Case Gage  
1" Bench Wrench  
Dillon Case Preparation Guide (Not Pictured)  
Mounting Hardware Kit

**Total: \$966.15**



"The Essentials," SDB 9mm



SDB Upgrade

# Reloading Packages

## XL 750 .223/5.56 Package, P44-35010:

XL 750 in .223/5.56  
Steel .223/5.56 Die Set  
D-Terminator Digital Scale  
*Lyman Reloading Manual*  
Digital Calipers  
Primer Flip Tray  
Dillon Case Lube  
.223/5.56 Case Gage

1" Bench Wrench  
Dillon Case Preparation Guide (*Not Pictured*)  
Mounting Hardware Kit

**Total: \$998.10**

## XL 750 Upgrade Kit, P44-35007:

550/650/750 Strong Mount  
Bullet Tray Kit  
Roller Handle

**Total: \$147.35**



"The Essentials," RL 550C 9mm



"The Essentials," XL 750 9mm



RL 550C  
Upgrade



XL 750  
Upgrade

**WARNING:** The products offered for sale in this catalog can expose you to chemicals, including Lead, which are known to the State of California to cause cancer, birth defects or other reproductive harm. For more information, go to [www.P65Warnings.ca.gov](http://www.P65Warnings.ca.gov).

**Blue Press 37**

# SAVE YOUR BRASS!



Pick up your brass the easy way! This takes the hard work out of policing up your brass. No more aching back from bending over or kneeling at the range!

P44-21894 \$46.95



The **SHELLSORTER** is a simple product designed to reduce the time you spend sorting brass, allowing you to enjoy more time reloading and shooting. The **SHELLSORTER** is comprised of three pans designed to sort several common calibers. The fastest way to sort is to stack all three of the pans together on a common five-gallon bucket, yellow pan on top and black on the bottom; in that way, with a few shakes all your brass is sorted by caliber at the same time. The **SHELLSORTER** is made of ABS, a strong plastic that will give a lifetime of service.

P44-19972 \$39.95

## Berry's Mfg. Bullet Puller<sup>^</sup>



Nobody's perfect. A bullet puller makes it easy to recover all your components.

Bullet Puller<sup>^</sup> P44-17999 \$29.95  
 Puller Cap<sup>^</sup> P44-17948 4.95  
 Collet Set P44-17947 5.99

## 38 Blue Press

## Berry's Mfg. Plated Bullets<sup>^</sup>

Description	Stock #	250	500	1000
<b>Bullets for the 7.62 x 39 Cartridge</b>				
123 gr. RN-DS*	P44-17210	\$42.00	\$81.00	\$150.00
<b>.380 Caliber Bullets</b>				
100 gr. RN-DS*	P44-17532	24.00	46.00	85.00
<b>9 Millimeter Bullets</b>				
115 gr. RN-DS*	P44-17533	25.00	49.00	90.00
115 gr. HBRN-TP*	P44-17178	27.00	52.00	96.00
124 gr. RN-DS*	P44-17534	27.00	51.00	95.00
124 gr. HBRN-TP*	P44-17272	30.00	57.00	106.00
124 gr. HBFP-TP*	P44-17385	30.00	57.00	106.00
147 gr. RN-DS*	P44-17535	31.00	60.00	110.00
<b>.357 Caliber Bullets</b>				
125 gr. FP-DS*	P44-17536	28.00	53.00	98.00
158 gr. RN-DS*	P44-17540	33.00	63.00	117.00
158 gr. FP-DS*	P44-17539	33.00	64.00	118.00
<b>.40 Caliber/10 Millimeter Bullets</b>				
155 gr. HBRN-DS*	P44-17238	36.00	70.00	130.00
165 gr. FP-DS*	P44-17232	36.00	70.00	130.00
165 gr. HBFP-DS*	P44-17271	41.00	79.00	146.00
180 gr. FP-DS*	P44-17542	38.00	74.00	137.00
180 gr. RN-DS*	P44-17515	35.30	68.26	127.00
<b>.45 Caliber Bullets</b>				
185 gr. HBRN-DS*	P44-17543	41.00	78.00	145.00
185 gr. FP-DS*	P44-17516	35.30	68.26	127.00
200 gr. HBFP-DS*	P44-17517	45.00	78.00	146.00
230 gr. RN-DS*	P44-17549	42.00	80.00	149.00
Description	Stock #	200	400	800
<b>.44 Caliber Bullets</b>				
240 gr. FP-DS*	P44-17545	39.00	76.00	140.00

\*DS = Double Struck, TP = Thick Plate, HB = Hollow Base, RN = Round Nose, FP = Flat Point, SWC = Semi Wadcutter, WC = Wadcutter

## Sierra Bullets<sup>^</sup>

(This is not LOADED ammunition.)

<b>5.56mm/.224 Caliber</b>				
52 gr. HPBT MatchKing	100/box	P44-10178	\$25.95	
55 gr. BlitzKing	100/box	P44-14458	28.95	
69 gr. TMK	100/box	P44-80015	29.95	
69 gr. HPBT MatchKing	100/box	P44-13007	27.95	
77 gr. TMK	100/box	P44-80016	35.99	
77 gr. HPBT MatchKing	500/box	P44-18171	157.95	
<b>6mm/.243 Caliber</b>				
70 gr. HPBT MatchKing	100/box	P44-12386	30.95	
<b>6.5mm</b>				
123 gr. HPBT	100/box	P44-14459	44.95	
142 gr. HPBT	100/box	P44-14460	46.95	
<b>7.62mm/.308 Caliber</b>				
125 gr. HP	100/box	P44-14448	39.95	
155 gr. TMK	100/box	P44-80018	48.00	
155 gr. HPBT Palma	100/box	P44-18160	39.95	
168 gr. TMK	100/box	P44-80017	47.00	
168 gr. HPBT MatchKing	100/box	P44-10177	42.95	
175 gr. HPBT MatchKing	100/box	P44-17481	44.95	

## Armcor Projectiles<sup>^</sup>

.38/.357 125 gr. RN	100/pkg.	P44-15823	\$10.50
.38/.357 158 gr. RN	100/pkg.	P44-15819	11.50

## Privi Partisan Projectiles<sup>^</sup>

.40 Cal. 180 gr. JHP	100/pkg.	P44-15812	\$17.99
.45 Cal. 230 gr. FMJ	100/pkg.	P44-15813	19.99

## Hornady Projectiles<sup>^</sup>

.30 Cal. 150 gr. FMJBT	100/pkg.	P44-44445	\$18.62
.38 Cal. 148 gr. HBWC (lead)	250/pkg.	P44-70011	31.79

800-223-4570 • 480-948-8009 • bluepress.com

# SNS Casting<sup>^</sup>

## Coated Hard-Cast Bullets

	Stock #	500	1000
.30 M1 Carbine RN 115 gr.	P44-15403	\$43.00	\$80.00
.380 RN 95 gr.	P44-15393	40.00	74.00
9mm RN 115 gr.	P44-13150	41.00	76.00
9mm CN (conical) 124 gr.	P44-15075	42.00	78.00
9mm FP 125 gr.	P44-15396	42.00	78.00
9mm RN 125 gr.	P44-15332	42.00	78.00
9mm <b>No Lube Groove</b> 125 gr.	P44-15756	42.00	78.00
9mm RN 135 gr.	P44-15043	44.00	81.00
9mm RN 147 gr.	P44-15044	47.00	88.00
9mm FP 147 gr.	P44-15333	47.00	88.00
9mm/.38 Super RN 160 gr.	P44-15397	52.00	97.00
.38/.357 RNFP 100 gr.	P44-15859	41.00	76.00
.38/.357 FP 105 gr.	P44-15860	42.00	77.00
.38/.357 FP 125 gr.	P44-15879	42.00	79.00
.38/.357 RNFP 130 gr.	P44-19679	44.00	81.00
.38/.357 DEWC 148 gr.	P44-15880	47.00	88.00
.38/.357 RN 158 gr.	P44-15045	52.00	97.00
.38/.357 SWC 158 gr.	P44-15881	52.00	97.00
.38/.357 RN 160 gr.	P44-15400	52.00	97.00
.40/10mm FP 140 gr.	P44-15335	47.00	87.00
.40/10mm RNFP 165 gr.	P44-19677	55.00	101.00
.40/10mm SWC 175 gr.	P44-15336	57.00	106.00
.40/10mm FP 180 gr.	P44-15337	58.00	107.00
.40/10mm RN 180 gr.	P44-10029	58.00	107.00
.40/10mm RN 200 gr.	P44-15338	60.00	112.00
.40/10mm FP 220 gr.	P44-15855	66.00	123.00
.44 RNFP 200 gr.	P44-15882	60.00	112.00
.44 SWC 240 gr.	P44-15891	69.00	129.00
.45 SWC 185 gr.	P44-15856	58.00	108.00
.45 RN 200 gr.	P44-15339	60.00	112.00
.45 RNFP 200 gr.	P44-15857	60.00	112.00
.45 SWC 200 gr.	P44-15340	60.00	112.00
.45 RN 230 gr.	P44-15401	66.00	124.00
.45 RN <b>No Lube Groove</b> 230 gr.	P44-19678	66.00	124.00
	Stock #	250	500
.30/30 RNFP 158 gr.	P44-15854	\$27.00	\$50.00

# Starline Brass<sup>^</sup>

Unprimed brass sold in packages of 100  
(This is not LOADED ammunition.)

Description	Stock #	1 Pkg.	5 Pkg.	10 Pkg.
.32 H&R Mag.	P44-30258	\$19.00	\$88.00	\$168.00
.32-20 Win.	P44-31282	25.00	116.00	224.00
9mm	P44-31277	17.00	79.00	152.00
.38 Short Colt	P44-39919	20.00	91.00	175.00
.38 Special	P44-31278	18.00	80.00	154.00
.38 Super +P	P44-31276	20.00	90.00	173.00
.38 Super Comp	P44-30257	20.00	90.00	173.00
.357 SIG	P44-30528	22.00	102.00	196.00
.40 S&W	P44-31283	20.00	93.00	180.00
10mm	P44-31281	21.00	98.00	188.00
.44 Special	P44-31280	24.00	111.00	214.00
.45 ACP	P44-31284	22.00	99.00	190.00
.45 Colt	P44-30259	24.00	111.00	214.00

# Once-Fired Brass

**BLOW-OUT Prices While Supplies Last!**

.40 S&W cases	1000/box	P44-43297	\$44.00
---------------	----------	-----------	---------



**Special Purchase .223 FMJ Projectiles<sup>^</sup>**

**55 Grain, 1000/pkg**  
**P44-44444 \$79.95**

# RCBS Trim Pro 2 Manual Case Trimmer

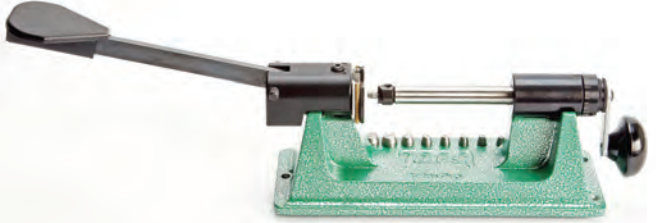

The RCBS Trim Pro-2 manual case trimmer features a spring-loaded "universal" shell holder that will accommodate case head diameters from .250" to .625". Comes with pilot calibers: .22, .24, .25, .27, .28, .30, .35, .44 and .45.

RCBS Trim Pro-2™ Case Trimmer **P44-43231 \$139.95**

# Ammo-Burr Cartridge Deburring Sets

SHAVIV is – and has been – the leader in precision hand-deburring solutions since 1960, and now brings its experience to the ammo-reloading market. The Ammo-Burr Inner/Outer Cartridge Deburring Sets feature ergonomic comfort-grip handles for fast and accurate hand deburring. The .47" diameter inner chamfering and deburring blade allows for chamfering and deburring cases from .17 to .45 caliber, and the outer-diameter chamfering blade will accommodate case mouth openings as large as 1.02".



Inner Chamfering Starter Set (Pictured) **P44-62270 \$24.95**  
Outer Chamfering Starter Set **P44-62269 34.95**

# Hornady O.A.L. Gauge and Bullet Comparator



## Overall Length Gauge<sup>^</sup>

The initial distance a bullet must travel when fired (from the cartridge case mouth until it engages the rifling) is absolutely critical to achieving peak accuracy.

Straight **P44-14622 \$38.95**

Curved (for auto, lever and pump rifles) **P44-14862 \$39.95**

## Modified Case<sup>^</sup> (required)

**\$6.99 each**

.223 Rem. **P44-14627**

.22-250 **P44-14628**

.243 Win. **P44-14631**

.270 Win. **P44-14641**

7mm Rem. Mag. **P44-14648**

.308 Win. **P44-14652**

.30-06 **P44-14653**

.300 Win. Mag. **P44-14655**

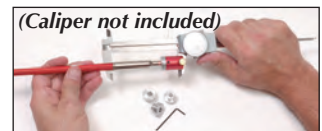

## Bullet Comparator

Correct bullet seating depth is critical to accuracy. In addition, minor variations in bullet seating depth will have an effect on both pressure and velocity.

Bullet Comparator **P44-14670 \$16.95**

## Comparator Insert (required)

**\$8.95 each**

.22 caliber **P44-14672**

.24 caliber **P44-14673**

.25 caliber **P44-14674**

.26 caliber **P44-14675**

.27 caliber **P44-14676**

.28 caliber **P44-14677**

.30 caliber **P44-14678**

.33 caliber **P44-14679**

.35 caliber **P44-14680**

.37 caliber **P44-14681**

.45 caliber **P44-14682**

**WARNING: These products contain lead, which is known to cause birth defects, other reproductive harm and cancer. Handling components, ammunition, cleaning firearms or discharging firearms in poorly ventilated areas may result in lead exposure. Have adequate ventilation at all times and wash your hands thoroughly after exposure.**

# Mr. Bulletfeeder<sup>®</sup>

## by Double-Alpha

**Mr. Bulletfeeder** has been around for some years now, and has gained a huge following worldwide. The patented system is by far the best performing personal-use bullet feeder on the market, and has been, since its introduction in 2006. Double-Alpha Academy has teamed up with RAK Systems, the original designer and patent holder of the system, to redesign and streamline the product, making it more compact, more versatile, better looking and more affordable than ever before.

The Mr. Bulletfeeder by Double-Alpha is now a production-grade product, with Double-Alpha Academy – a world leader in practical-shooting-related product manufacturing and distribution – at the helm. The design allows the bullet collator to be mounted onto the casefeeder, eliminating any increased footprint and space use, and the new patent-pending dropper is a huge step forward in design, durability and reliability.

### Mr. Bulletfeeder Set Up in One Caliber

9mm/.38/.357	<b>P44-15145</b>	<b>\$469.95</b>
.40 S&W/10mm	<b>P44-15146</b>	<b>469.95</b>
.45 ACP	<b>P44-15148</b>	<b>469.95</b>
.223 Rem./5.56 NATO	<b>P44-15150</b>	<b>493.95</b>
.30 cal./7.62mm	<b>P44-15153</b>	<b>499.95</b>
6.5mm	<b>P44-15154</b>	<b>499.95</b>

### Mr. Bulletfeeder Caliber Conversions

9mm/.38/.357	<b>P44-15168</b>	<b>\$149.95</b>
.40 S&W/10mm	<b>P44-15169</b>	<b>149.95</b>
.45 ACP	<b>P44-15170</b>	<b>149.95</b>
.223 Rem./5.56 NATO	<b>P44-15171</b>	<b>169.95</b>
.30 cal./7.62mm	<b>P44-15172</b>	<b>182.95</b>
6.5mm	<b>P44-15173</b>	<b>182.95</b>

### Replacement Bullet Dropper Dies

9mm/.38/.357	<b>P44-10218</b>	<b>\$94.95</b>
.40 S&W/10mm	<b>P44-10219</b>	<b>94.95</b>
.45 ACP	<b>P44-10220</b>	<b>94.95</b>
.223 Rem./5.56 NATO	<b>P44-10221</b>	<b>94.95</b>
.30 cal./7.62mm	<b>P44-10236</b>	<b>94.95</b>

### Replacement Output Tube Assemblies

Small Output	<b>P44-10238</b>	<b>\$34.95</b>
Large Output	<b>P44-10239</b>	<b>34.95</b>

### Replacement Nose Guide Spacers

Set of Four	<b>P44-10237</b>	<b>\$2.95</b>
-------------	------------------	---------------

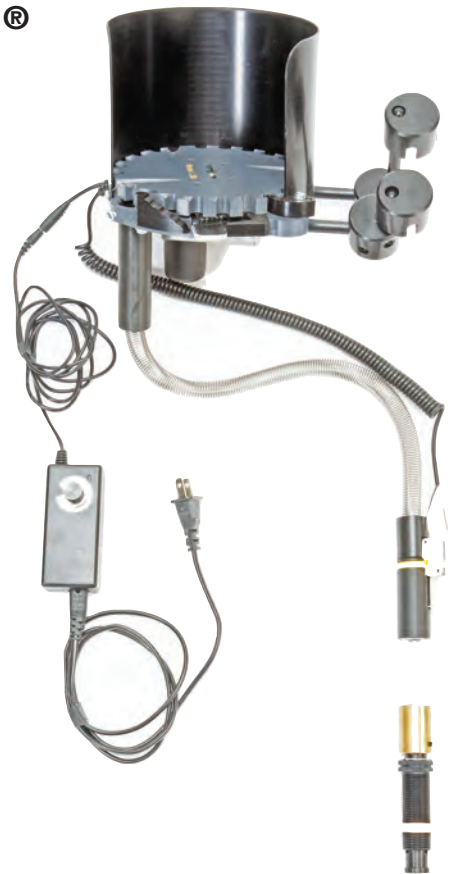

# BL 550<sup>^</sup>

## Dillon's Basic Loader

**\$289<sup>95</sup>**

**P44-15399**

Reloading Dies and Caliber Conversions sold separately  
(See the back of the order blank in the center)

Pictured with optional accessories:  
Strong Mount **P44-22051** \$52.45

Dillon's RL 550 has long worn the title of "The World's Most Versatile Progressive Reloader," and stripping it down to its most basic form – Dillon's BL (Basic Loader) 550 – adds a whole new dimension of

versatility for the shooter/hunter who needs to feed several rifles. The BL 550 is essentially an RL 550 without the automatic priming and powder systems. Capable of loading over 160 calibers – just like the RL 550 – it uses any manufacturer's standard 7/8" x 14 reloading dies. It's priced comparably with other manufacturers' turret presses; yet unlike them, it's fully upgradeable to Dillon's Progressive RL 550 loader! The interchangeable toolhead (Page 15) makes it quick, easy and inexpensive to change calibers. The additional toolheads are \$26.95 each, or \$24.95 each if you

buy three or more – if you load for several rifles it's a no-brainer! Once you get your dies adjusted, you'll never have to re-set them. A powder measure adapter is available if you want to use a manual measure that you already own. Or, if you want to weigh every powder charge you load, it's easy – you can use a powder trickler with the powder die/funnel assembly that comes with the BL 550.

**AUTO PRIME SYSTEM<sup>^</sup>** **P44-16627** **\$90.95**

**PRIMER SYSTEM EARLY WARNING<sup>^</sup>**

Allows you to focus on loading instead of worrying about failing to seat a primer, and is an easy slip-on attachment to the auto prime system. **P44-20302** **\$27.95**

**AUTO POWDER SYSTEM<sup>^</sup>**

Accurate to within 0.1 grain, our Automatic Powder Measure is world renowned for its charge-to-charge consistency. **P44-20251** **\$96.95**

**OPTIONAL MAGNUM RIFLE POWDER BAR** **P44-21353** **\$33.95**

**AUTO EJECT SYSTEM<sup>^</sup>**

Greatly increases your ammo production capabilities and adds a Cartridge Chute/ Bracket and a Cartridge Bin to your reloader. **P44-22120** **\$33.95**

**BL 550 POWDER DIE<sup>^</sup>**

Extra powder dies for your BL 550 make it easier to set up additional toolheads for loading different calibers.

**Powder Die:** **P44-16629** **\$20.95**

**Oversize Die:** **P44-16626** **20.95**

**Plastic Funnel:** **P44-16617** **6.95**

**POWDER MEASURE ADAPTER**

If you load rifle cartridges with long-grain extruded powder, you can now use any manufacturer's powder measure with 7/8" x 14 threads on your RL 450, AT 500, BL 550 or RL 550. (Requires the use of an RL 450 powder die – see below.) **P44-20029** **\$24.95**

**RL 450 Powder Die** **P44-20308** **23.95**



# Our Pride, Your Sleeve



### Dillon/Precision Logo, Black

Small	P44-43411	\$19.95
Medium	P44-43412	19.95
Large	P44-43413	19.95
X-Large	P44-43414	19.95
XX-Large	P44-43415	20.95
XXX-Large	P44-43416	21.95

### DP Box Logo, Black

Small	P44-43436	\$19.95
Medium	P44-43437	19.95
Large	P44-43438	19.95
X-Large	P44-43439	19.95
XX-Large	P44-43440	20.95
XXX-Large	P44-43441	21.95

### Dillon Logo/Rifle, Black Long Sleeve

X-Large	P44-43450	\$21.95
2X-Large	P44-43451	22.95

### DP Box Logo, Black Long Sleeve (not pictured)

X-Large	P44-43448	\$21.95
2X-Large	P44-43449	22.95

### Dillon/Precision Logo, Charcoal

Small	P44-43418	\$19.95
Medium	P44-43419	19.95
Large	P44-43420	19.95
X-Large	P44-43421	19.95
XX-Large	P44-43422	20.95
XXX-Large	P44-43423	21.95

### DP Box Logo, Charcoal

Small	P44-43442	\$19.95
Medium	P44-43443	19.95
Large	P44-43444	19.95
X-Large	P44-43445	19.95
XX-Large	P44-43446	20.95
XXX-Large	P44-43447	21.95



### Straight Dillon Logo, Black

Small	P44-43424	\$19.95
Medium	P44-43425	19.95
Large	P44-43426	19.95
X-Large	P44-43427	19.95
XX-Large	P44-43428	20.95
XXX-Large	P44-43429	21.95

### Dillon Logo/Rifle, Charcoal

Small	P44-43430	\$19.95
Medium	P44-43431	19.95
Large	P44-43432	19.95
X-Large	P44-43433	19.95
XX-Large	P44-43434	20.95
XXX-Large	P44-43435	21.95

## Wear the "Dillon" Brand



Gray, XL	P44-18524	19.95
Gray, XXL	P44-18525	20.95
Gray, XXXL	P44-18526	22.95
Black, Large	P44-18515	19.95
Black, XL	P44-18516	19.95
Black, XXL	P44-18517	20.95
Black, XXXL	P44-18518	22.95

### Short-Sleeve Dillon Precision T-Shirt

Navy, L	P44-18511	\$12.50
Navy, XL	P44-18512	12.50
Navy, XXL	P44-18513	14.50
Navy, XXXL	P44-18514	14.50
Gray, Large	P44-18527	12.50
Gray, XL	P44-18528	12.50
Gray, XXL	P44-18529	14.50
Gray, XXXL	P44-18530	14.50
Black, Large	P44-18519	12.50
Black, XL	P44-18520	12.50
Black, XXL	P44-18521	14.50
Black, XXXL	P44-18522	14.50



### DP Box Logo Caps \$22.95 ea.

The NEW DP Box Logo on the One and Only Original Flexfit® cap – the original stretchable fitted cap featuring the Flexfit technology. With polyurethane woven into the sweatband, this all-purpose hat delivers the perfect blend of comfort and style for sports and casual wear.

Navy Small/Medium Flexfit Cap	P44-43455
Navy Large/X-Large Flexfit Cap	P44-43453
Black Small/Medium Flexfit Cap	P44-43454
Black Large/X-Large Flexfit Cap	P44-43452

**WARNING:** The products offered for sale in this catalog can expose you to chemicals, including Lead, which are known to the State of California to cause cancer, birth defects or other reproductive harm. For more information, go to [www.P65Warnings.ca.gov](http://www.P65Warnings.ca.gov).

# John Marshall on Classic Firearms:

The German Sauer 38H pistol was one relic of World War II that I had only vaguely heard about for quite a number of years, so, curious, I began investigating it more thoroughly. I learned enough about it to become fascinated, and sought to find one to examine. Just recently I came across a very nice example of the gun to see what they were all about.

Reactions of many upon seeing the pistol are amusing. Here's a representative one: "So," a friend said. "Whatcha got there, a Walther PPK?"

"No." I replied.

"Is it a Mauser HSc??"

"Nope." He looked at it with more interest.

"Aha!" he exclaimed. "It's a Sauer 38H! I've never actually seen one!"

Most folks are like my friend – either not knowing or only vaguely knowing about this pistol that was prolifically used by the German military and police during World War II. At the end of the European part of the war, production ground to a halt, with the Sauer plant finding itself in the partitioned East German State. Unlike the PPK and the HSc, the 38H was never resurrected into further production. That was unfortunate, because it was quite technologically advanced, perhaps even more so than its contemporary Teutonic "pocket pistol" competitors. Still, a number of its then-innovative features were adopted in the postwar years by other pistols in varying ways.

The gun was a product of J.P. Sauer & Sohn, founded in 1751, of Suhl, Germany. The "38H" name referred to its 1938 year of introduction, and the fact that although it looked like a hammerless design, it actually had an internal hammer, or *hahn*, in German. Because it had no external hammer, a mechanism was needed that could both cock the internal hammer and lower it safely. Therefore, a cocker/de-cocker lever was incorporated on the left side of the gun, usually operated by the thumb of a right-hander. If the gun's hammer was cocked and the trigger back for single-action fire, pressing the lever down de-cocked the hammer safely. This also made the trigger go forward to the double-action mode. Amazingly and uniquely, if the hammer was down and the trigger was forward, pressing the same lever down all the way would cock the hammer and draw the trigger back! This general arrangement was passed on to many of the SIG-Sauer pistols of today; a similar side lever will de-cock their external hammers in a safe manner. Also, the Heckler & Koch P9S pistol emulated the 38H by using a side lever that could both cock and de-cock its internal hammer.

Another feature, unique in those days, was that the breechblock was a separate unit from the bulk of the

slide, using a higher grade of steel, which was kept "in the white." It was pinned into the rear of the slide. This arrangement is mimicked today by the highly regarded SIG Sauer P220/226 – the slide has a similar pinned-in breechblock. The 38H's 8-round .32 ACP / 7.65mm magazine drops freely with a push of a button located to the rear of the trigger. When the magazine is removed, the trigger is inactivated, a safety feature that was relatively uncommon in those days. That magazine safety in no way interfered with the trigger pull, either double action or single action. With the internal hammer down, the first shot could be fired double action, and successive rounds were then triggered in the sin-

gle-action mode. Repeat strikes on a tough primer were possible. When the slide-mounted safety lever was down, exposing a red dot, the gun could be fired in either mode. When the lever was up, it disconnected the trigger when the gun was in single-action mode. When the piece was set for double-action mode, the engaged safety blocked the trigger and also locked the slide from moving. A pin at the rear of the slide was a loaded-chamber indicator, protruding slightly where it was easily seen or felt if the chamber had a round in it. The trigger had a round hole through it, which was concealed when the hammer was cocked for single-action fire, making the trigger and hammer's status easily discernible.

Takedown of the pistol for cleaning purposes is very easy. After removing the magazine and clearing the chamber, notice that there is an "eared" block in front of the trigger that can be pulled straight down. Then the slide can be brought all the way back, the rear end lifted, and it can be slid off the fixed and pinned barrel in a forward direction. The recoil spring is wrapped around the barrel, and can be easily removed. Taking off the grips will expose the action parts. By the way, the grips were made of Bakelite plastic – an early synthetic that was new in those days. It now has a habit of decomposing, cracking or crumbling with age. Finding one of these pistols with the grips intact is unusual now, because they are so fragile. The left grip is marked

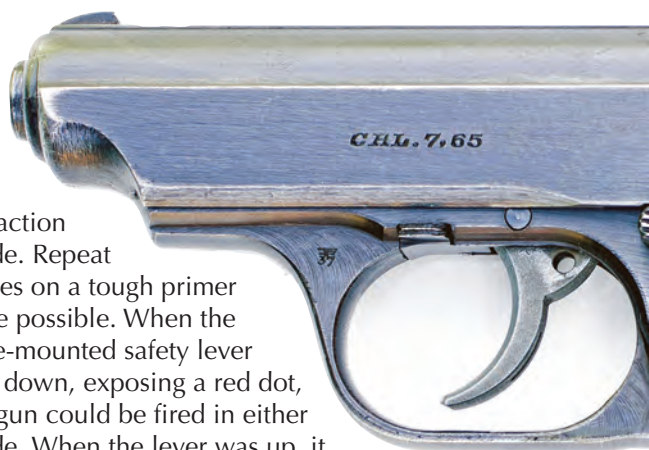

# The WWII German Sauer 38H Pistol

with the intertwined “S u S” Sauer logo, standing for *Sauer und Sohn* (Sauer and Son). The magazines were usually marked “CAL. 7,65”, and sometimes also with the Sauer logo on the base plate.

Although the 38H was devised in 1938, full production did not start until 1939. It continued to be made through the war years (1939 – 1945) until the Russians overran the plant in Suhl in April 1945. It then faded into history. The machinery that was used to make the pistol was taken apart and moved East by the Soviets. Also removed from the plant was its manager, a Sauer descendant. He was never heard from again.

It's estimated that roughly 250,000 of the 38H were



made in total, with available production records being ruefully incomplete. A 6-digit serial number can be found on either side of the pistol, on the frame just under the rear of the slide. The last 3 digits of the serial number should be stamped inside the slide and at the rear of the breech-block. All numbers

should match if original. Military serial numbers reportedly run from 271456 to 506527.

Markings vary from full identification stamps to none except for the caliber marking, which was uniformly stamped on the left of the slide as “CAL. 7,65”. The Sauer logo remained on the left grip throughout all production. Almost all of these pistols were chambered for .32 ACP, although it's believed that a few were made in .380 ACP and .22 LR. Quality of fit and finish diminished over the years of the war, with tooling marks and weak bluing becoming

common as time wore on. Due to heavy demand for faster production, towards the end of the war the safety lever and/or the cocker/de-cocker lever were omitted. Fit and finish became spotty, and quite a number of examples from the final year do not have matching parts numbers or even a caliber marking on the slide. Still, these “last ditch guns” remained serviceable and deadly. The pistol illustrated here is believed to have been made mid-war, probably in 1943. It carries German “eagle over N” proof marks on the right side of the slide and frame. The military *waffenamt* acceptance stamp, which for armed services pistols was an “eagle over 37,” is stamped on the left side of the trigger guard. It's known, although no specific allocation records now exist, that 38H pistols were issued to the *Wehrmacht*, the *Luftwaffe*, the *Polizei* and the *Fallschirmjagers* (Army, Air Force, Police and Paratroopers). Some also went to the Nazi party. It's believed that few or none went to the *Kriegsmarine* (Navy). Police guns usually had a special *waffenamt* stamp of “eagle over C or F” on the trigger guard. These are considered more desirable by collectors. A number of pistols were produced for the commercial market and these will not have *waffenamt* stamps.

The overall length of the pistol was 6.73 inches, with the barrel measuring 3.3 inches. It weighed 1 pound and nine ounces. A very few were made experimentally with alloy frames. The action was straight blowback; the slide movement was resisted only by the strength of the recoil spring, the resistance of the internal hammer and the weight of the slide. The front sight was fixed, while the rear sight could be drifted laterally for proper sighting. The top of the slide had a longitudinal strip between the sights that was serrated to prevent glare. The slide did not remain open after the last shot, as there was no slide stop device. Some guns with deluxe features such as engraving, gold inlay, and ivory grips were presented to various Nazi officials. A presentation 38H that once belonged to Sepp Dietrich (1892-1966), former chauffeur and bodyguard to Adolf Hitler and later an SS panzer general, sold at auction for over \$43,000 in 2004!

This “ghost gun” of World War II has come alive for me, as I'm pleased to have finally discovered one in decent shape. It was ground breaking during its time in history, and its legacy lives on with many similar features in the modern SIG Sauer pistols. The surviving 38H pistols have become great collectibles now. Values are dependent on the quality of the finish, matching serialized parts, presence or absence of markings, safety levers, cocker/de-cocker levers and original intact Bakelite plastic grips.

# "Big Fifty" <sup>^</sup>

## STANDARD FEATURES:

- Made in the USA
- 4-Station Interchangeable Toolhead
- Uses Std. 1-1/2"-12 UNF Thread Dies
- Manual Shellplate indexing
- Average Loading Rate: 300 Rds./Hr.
- Loads High Volume/Match-Grade Ammo
- Milspec/Match-Grade Priming System
- Ductile Iron/Carbon Steel Construction

All for ONLY...

**\$1344<sup>95</sup>**

P44-50000

Now Available!

.408 CheyTac Conversion P44-50204 \$189.95

(Dies NOT Included)



Total price as pictured here with optional accessories: \$3069.75

.50 BMG Carbide Size Die	P44-50075	\$984.95
.50 BMG Case Trimmer	P44-50050	\$419.95
BFR Mounting Hardware Kit	P44-50140	\$9.95

## 50 BMG CASE TRIMMER ASSEMBLY <sup>^</sup>

Features an industry standard 1-1/2"-12 UNF threaded body, a 1/4 HP motor, replaceable carbide cutter, quick-disconnect cord and includes the .50 BMG trim die. P44-50050 \$419.95

## 50 BMG CARBIDE SIZE DIE <sup>^</sup>

The only .50 BMG size die in the industry that's a full-length solid carbide size die, for increased die life and scratch resistance. It also has a solid carbide expander ball, placed in the middle of the power stroke for easier operation. The die body is standard 1-1/2"-12 UNF thread, and is manufactured to low chamber tolerance specifications. P44-50075 \$984.95

## 50 BMG POWDER MEASURE ADAPTER <sup>^</sup>

For use with the RCBS .50 BMG powder measure. P44-50125 \$87.95

## 50 BMG PRIMER SEATING DIE <sup>^</sup>

One of these is included with Dillon's Big Fifty Reloader, but may be used as an accessory on a separate toolhead. The primer seating die is adjustable for enhanced control of primer seating. Includes two primer punches: one flat, match-style primer punch and one cupped, MIL-SPEC primer punch. P44-50200 \$169.95

## 50 BMG PRIMER POCKET SWAGER <sup>^</sup>

Makes it easy to remove the military crimp. P44-50001 \$354.95

## PRIMING CONVERSION <sup>^</sup>

Converts Swager to Priming System. P44-50003 \$89.95

## 50 BMG PRIMING SYSTEM <sup>^</sup>

Allows off-the-machine primer seating. P44-50002 \$354.95

## (1) SWAGER CONVERSION <sup>^</sup>

Converts Priming System to Swager. P44-50004 \$89.95

## RCBS .50 BMG LOADING ACCESSORIES <sup>^</sup>

.50 BMG Powder Measure P44-21896 \$114.95

# SL 900 <sup>^</sup>

## STANDARD FEATURES:

- Made in the USA
- Automatic Indexing
- Auto Powder/Priming Systems
- Adjustable Case-Activated Shot System
- Factory Adjusted to Load AA Hulls
- Factory Adjusted Loading Dies
- The Original Tilt-Out Wad Guide
- Lifetime "No-B.S." Warranty
- RISK FREE 30-Day Trial Period!

All for ONLY...

**\$1069<sup>95</sup>**

\$1329.90 with Casefeeder



12 Gauge P44-97110 20 Gauge P44-97123  
28 Gauge P44-97124 Comes with factory adjusted dies

Total price as pictured here with optional accessories: \$1373.85

12 Gauge Casefeeder (pictured)	P44-97037	\$259.95
20/28 Gauge Casefeeder	P44-97036	259.95
12 Ga. Euro. 220v Casefeeder	P44-97118	269.95
20/28 Ga. Euro. 220v Casefeeder	P44-97125	269.95
Low Powder Sensor	P44-16306	43.95

## SL 900 CONVERSIONS <sup>^</sup>

12 Gauge Conversion	P44-20009	\$381.95
12 Gauge Casefeed Plate	P44-17811	44.95
20 Gauge Conversion	P44-22138	381.95
28 Gauge Conversion	P44-22139	381.95
20/28 Gauge Casefeed Plate	P44-97045	44.95
SL 900 Powder System	P44-17817	85.95

## SL 900 MACHINE COVER <sup>^</sup>

This heavy-duty nylon cover comes equipped with a D-ring, allowing the zipper to be locked. P44-13239 \$39.95  
Master lock P44-13083 \$3.95

## PACKAGE DEAL <sup>^</sup>

Includes: Lyman Reloading Handbook, Clear Safety Glasses, Dial Caliper, Eliminator Scale, Machine Cover, and Low Powder Sensor. P44-22290 \$223.95

## SPARE PARTS KIT <sup>^</sup>

1 20 Gauge Yellow Wad Guide	1 Ejector Wire
1 28 Gauge Green Wad Guide	1 Plastic Wad Guide
1 20 Gauge Locator Pin	1 Swing Arm Torsion Spring
1 Index Pawl	1 Primer Transfer Arm
1 Ring Indexer	1 12 Gauge Locator Pin
1 Index Spring Revision A	1 Gum Rubber Insert Revision B
1 Hair Pin Cotter	1 Shot Fitting E-Clip
2 Bellcrank Cubes	1 Failsafe Bushing Revision B
1 Case Insert Slide Spring	P44-11154 \$29.95

# Dillon's Transparent Ammunition Boxes<sup>^</sup>

Description	Stock #	Each	Case (50)
.22 LR/.25 ACP (100 rd)	P44-80038	\$1.76	\$79.00 (50)
.380/9mm (50 rd)	P44-80019	1.73	78.00 (50)
.380/9mm (100 rd)	P44-80033	2.83	127.50 (50)
.38/.357 (50 rd)	P44-80020	1.73	78.00 (50)
.38/.357 (100 rd)	P44-80034	2.83	127.50 (50)
.44 Mag./45 Colt (50 rd)	P44-80023	2.05	92.50 (50)
.44 Mag./45 Colt (100 rd)	P44-80036	3.15	142.00 (50)
.40 S&W/.45 ACP (50 rd)	P44-80024	2.05	92.50 (50)
.40 S&W/.45 ACP (100 rd)	P44-80037	3.15	142.00 (50)
.223/5.56 (50 rd)	P44-80022	2.05	92.50 (50)
.223/5.56 (100 rd)	P44-80035	3.15	142.00 (50)
.243/.308 (20 rd)	P44-80039	1.90	85.50 (50)
.243/.308 (50 rd)	P44-80025	2.23	100.00 (50)
.30-06 (20 rd)	P44-80040	2.04	90.00 (50)
.30-06 (50 rd)	P44-80026	2.28	102.50 (50)
20 Gauge Shotgun (25 rd)	P44-80044	2.24	101.00 (50)
12 Gauge Shotgun (25 rd)	P44-80045	2.24	101.00 (50)

Extra Loading Data Labels, P44-10446, Package of 100, \$6.95

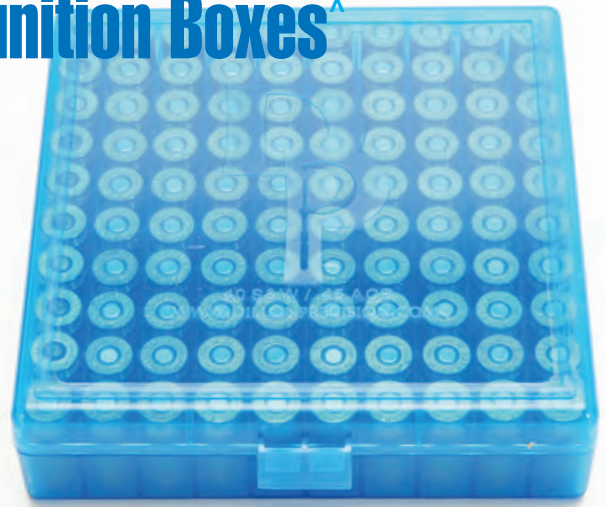

AMMO BOXES ARE COVERED BY DILLON'S LIFETIME WARRANTY



## Dillon AkroBins<sup>^</sup>

AkroBins are ideal for reloaders who load several calibers, bullet weights, bullet shapes, etc. We've been including these bins with our machines for years, and now we're stocking them in quantity for our customers.



- The small bins (the ones we use as Square Deal "B" cartridge bins) are 4-3/4" long x 3-7/16" wide x 2-13/16" deep.
- The RL 550/XL 650/750 cartridge bins are 6-3/4" long x 3-7/16" wide x 2-13/16" deep.
- The 1050 bins are 10-1/4" long x 4-3/8" wide x 4-3/4" deep.
- The double-extra-large bins we use on our SL 900 measure 13-3/4" long x 6-1/2" wide x 6-3/4" deep (all inside dimensions).

AkroBins are made of heavy-duty polypropylene with permanent, molded-in color (ours are blue). They're virtually unbreakable; unaffected by weak acids and alkalis, and are also water, rust and corrosion proof. Hang 'em, stack 'em, rack 'em and fill 'em – you just can't beat 'em! Buy several and get your "stuff" together.

Description	Stock #	Each	6 ea.	12 ea.
"Square Deal" Bin	P44-13756	\$2.95	\$15.30	\$24.84
"RL 550/XL 650/750" Bin	P44-13839	2.95	15.30	24.84
"RL 1050" Bin	P44-13484	6.95	34.92	61.92
"SL 900" Bin	P44-17125	10.50	56.94	106.92

## Berry's Mfg. Ammo/Storage Boxes<sup>^</sup>

Description	Stock #	Each	10 ea.	50 ea.
.500 S&W (50 rd)	P44-19243	\$2.98	\$22.40	\$97.00
NOTE: .500 S&W Ammo Boxes also fit .223/.243/.308 WSSM				
.454 Casull (50 rd)	P44-19244	2.98	22.40	97.00
.45/70 (50 rd)	P44-19245	3.29	24.20	105.00
7.62 x 54R (50 rd)	P44-19247	3.50	25.50	110.50
.300 Ultra (50 rd)	P44-19246	3.50	25.50	110.50
<b>Storage Boxes</b>				
4-3/8" x 2" x 1-5/8"	P44-19250	\$1.12	\$8.40	\$36.50
4-1/2" x 4-1/2" x 1-5/8"	P44-19251	2.32	17.40	75.50
5-1/2" x 2-5/8" x 2-1/2"	P44-19252	2.22	16.70	72.00

## Berry's Mfg. "20 Caliber" Ammo Can

Modeled after the military can, this tough unit is injection molded out of a tough polymer, has a gasket sealed lid, and a cam-lock latch to protect your contents. Also features a collapsible handle for easy stacking and storing.

Dimensions: 9.25" L x 3.125" BW x 3.125" TW x 2.5" H

LIFETIME WARRANTY. MADE IN THE USA

P44-12296 \$8.99



## Dillon Utility Boxes<sup>^</sup>

Dillon's Utility boxes are ideal for all those accessories that don't quite fit into the compartments of your shooting bag. The large box measures 13-1/2" x 5-3/4" x 2-1/4" and the small box measures 4-5/8" x 6-3/8" x 1-5/8". Use them for cleaning gear, extra magazines, repair parts, first aid supplies, reloading accessories and tools – the list is endless.

Description	Stock #	Each	5 ea.
Small Utility Box	P44-13636	\$2.95	\$12.45
Large Utility Box	P44-17195	5.75	23.95

**WARNING:** The products offered for sale in this catalog can expose you to chemicals, including Lead, which are known to the State of California to cause cancer, birth defects or other reproductive harm. For more information, go to [www.P65Warnings.ca.gov](http://www.P65Warnings.ca.gov).



By Duane Thomas

If you find yourself sucked into the wonderful world of being a serious shooter, in short order you start seeing the advantages to joining a gun range. In this article I'll give you my advice on how to choose which range to join, based on coming up on 35 years of experience at this whole "gun" thing.

Before we get started, let me say that what's in this article is just my biases, based on my experiences, and I'm under no illusion it's anything else. Also, I'm going to talk in this article a fair bit about Wade's Eastside Guns in Bellevue, Washington ([wadesguns.com](http://wadesguns.com)). I know that for those of you living in, say, Wisconsin, it doesn't matter how great is Wade's, because you couldn't possibly become a member there. I don't want this article to sound like a Wade's infomercial – it's not – I'm just using it as an example of a gun range that does things right, so you can know what to look for, yourself.

#### SAVINGS

The most obvious reason to join a gun range is to save money. Paying a range fee every time you go shoot, if you do that frequently, adds up fast. Once you're a range member, you can shoot there for free, as much as you want, for as long as your membership lasts.

In my neck of the woods, western Washington State, the going rate for an annual membership at a gun range is \$350. I've been told by friends living on the East Coast it's the same there, so I assume that's pretty standard. If you're willing to go into the boonies to some

small range in the middle of nowhere, you can get that down to about a third of that.

**Piece of advice #1:** Don't cheap out. \$125 a year instead of \$350 a year sounds like a great deal until you realize you get what you pay for. If the deal sounds too good to be true, it probably is.

I'm a serious competition shooter who makes his living as a gunwriter, so I shoot a fair amount. My annual ammo expenditure generally hovers somewhere around 15,000 rounds. (Thank you, Dillon Precision Square Deal, I couldn't do it without you.) By the standards of a serious shooter, that's not a huge round count, by the way, maybe slightly above average. Given my druthers, I go to the range around twice a week, partly because it's my job, partly because I just enjoy shooting. And I shoot every match I can.

At Wade's, to shoot there all day costs \$25. To compete in an Action Shooting International match there (more about which later) costs \$20. But let's say I only went to the range once every two weeks, and I only shot half-a-dozen ASI matches ([asi-usa.org](http://asi-usa.org)) at Wade's per year. In other words, let's say I'm not me; I'm some hypothetical shooter who's pretty into it but not obsessive. Let's do the math. Okay, carry the one... That's \$770 a year. If I were me, it would probably be about four times that. It doesn't take long to figure out the \$350 annual membership fee is a good deal.

#### LIFE MEMBERSHIP?

If you're really serious about this whole "gun range membership" thing, consider a Life membership. I

know, that may sound like something totally out of your financial league. Not necessarily. Wade's Life membership costs \$750. If you become an Annual member for \$350, and upgrade to Life within 90 days of your Annual membership taking effect, all you have to do is pay them the \$400 balance. Essentially, you can break a Life membership into multiple payments, you've got three months to pay it off, then you're a member of that range, and can shoot there for free, literally for the rest of your life. Or until the range goes out of business, of course, which in this case doesn't show any signs of being soon. When you find a deal like that, jump on it with both feet.

**Piece of advice #2:** Gun range membership saves money, and Life membership can be surprisingly affordable. Ask not just about an Annual membership but also about how much a Life membership costs. The answer might surprise and delight you. Don't be afraid to use the Internet, or make some phone calls; do some comparison-shopping.

### OUTDOOR OR INDOOR RANGE?

Some of the best gun clubs in America are outdoor ranges. Rio Salado, Norco, and PASA come to mind. In my area of western Washington State, the Renton Fish & Game Club and Paul Bunyan are both notably good. Having said that, honestly, over time I've found myself gravitating more and more toward indoor instead of outdoor gun ranges.

Many gun clubs have outdoor ranges, located in remote rural areas. Outdoor ranges get frickin' cold in wintertime. And all INDOOR ranges are not created equal. "Indoor range" might mean a large, well-built, well-heated, well-maintained, modern facility, or it might be a small, concrete block building that was built out in the boonies 60 years ago.

Rural-located indoor ranges tend to have been built on the cheap; they're very poorly insulated, with grossly inadequate heating systems. Folks, I have shot on little indoor ranges over the years so thinly insulated, with heating systems so poor, in the dead of winter it was colder inside that bare concrete block building than outside – I say that having measured both temperatures with the thermometer I carry in my range bag, as part of my shooting gear, to measure ambient temp when using a chronograph – because the concrete floor just absorbed and radiated the cold, the heating system was essentially useless, and that was before I turned on the fans for ventilation and added wind chill into the equation. No exaggeration, I have almost gone hypothermic, shooting on poorly insulated and heated indoor ranges.

This is a safety issue. Hands get cold and clumsy. Mental acuity suffers. "Fumble-prone" and "gun" are not two concepts that go well together. If possible, step out onto that shooting range in winter. Is it warm, well

heated, pleasant? Or do you feel like you just stepped into an icebox? If it's summer, is it sweat-inducingly hot inside? If a building has no cooling system, the heating system probably isn't the greatest either. Make your choice of whether to give this place your hard-earned money accordingly.

**Piece of advice #3:** If year-round shooting capability is important to you, go for a well-heated indoor range. If at all possible, stay away from outdoor ranges, and stay away from poorly constructed, essentially unheated rural indoor ranges, both of which are very seasonal propositions, unless you're just totally hardcore and immune to cold.

### CITY OR COUNTRY?

I assume the vast majority of you reading this are political conservatives. As political conservatives, we can have a tendency to distrust people in large cities – probably nasty liberals who hate guns and vote Democrat – and glamorize small town life, "the heartland of America." At the risk of coming across as a horrible elitist, here is my next piece of advice: I advise choosing a gun range located in or near the largest urban center within easy driving distance. Let's discuss why.

Okay, here I'm going to use Wade's Indoor Range as my example, and you can apply the info I give you to your own situation. Wade's is located in Bellevue, Washington. For those of you not familiar with it, Bellevue is a suburb of Seattle, and is called by locals "the Beverly Hills of Seattle." If you live in Seattle, and you have money, you probably live in Bellevue. And you probably have some sort of tech job: Bellevue is located right next to Redmond, which is the home base for Microsoft. You are well educated, you have a good job, you make good money, and when you frequent a business, you expect service. You're used to being treated well. You expect a large, gorgeous, well-equipped, well-maintained, clean facility, staffed by personable, knowledgeable, friendly employees who can answer your questions, and genuinely like helping people.

**Piece of advice #4:** You should probably avoid little local gun clubs. Again, I could be wrong, your little local gun club may be awesome. But I would look in and around a major urban center, in the most affluent area your bank account can afford. You really do get what you pay for, and money spent on membership at a first-class facility will pay for itself in quality of service received many times over.

### PISTOL-RATED OR RIFLE-RATED?

Some of the small rural gun clubs have an indoor range with a backstop that's only pistol-rated. (Here we go back to the "built on the cheap" concept.) Therefore they don't allow centerfire rifle cartridges to be fired on that range, it would just beat up the backstop too much. They are PARANOID someone is going to fire a rifle on that range. Okay, I get that.

Now, to how many of us is the ability to fire a rifle on the range important? Given that the AR-15 has been the best-selling firearm in America every year for the past decade, and that a huge number of people look for a place to sight-in their hunting rifle every year, I would say it's important to a lot of us.

**Piece of advice #5:** Stay away from pistol-rated ranges, go for a range with a true, rifle-rated backstop.

### PERSONNEL

A lot of people working in gun shops, and at shooting ranges, have a law enforcement or military background. Okay, what I am about to say comes from a person who spent 10 years on active duty in the United States Army, the first three as an Airborne paratrooper, and who's known police officers I consider some of my personal heroes. Obviously, I like military people, and I like cops. Having said that – and meaning it – let's not kid ourselves, the fact a person is wearing, or used to wear, a particular uniform does not automatically make them a gun expert. This is a fact lost on a certain percentage of people wearing, or having worn, uniforms.

Most new military members, and most police cadets, report for training having never shot any sort of firearm before in their life. Most soldiers and police officers have never fired any gun other than their issue weapon. They get trained to a level that could in no way be described as expert, then most of them never fire that gun again unless they're forced to during re-qualification, which in the Army when I was in – it may have changed now but I doubt it – meant 40 rounds out of a rifle once a year if you were enlisted, or, if you were an officer, 30 rounds out of a pistol. In most police departments, it's 50 rounds out of a pistol once a year. In really high-speed departments, it might be 50 rounds twice a year. Rarely is it more.

You do not want the person answering your questions at the shooting range to be a guy whose entire gun résumé reads, "Used to wear a uniform." Here is one place where I simply must again mention Wade's. To work at Wade's Indoor Range, you must have passed the qualification course created by the Washington State Criminal Justice Training Commission to be not just a SWAT team member, but also a SWAT team INSTRUCTOR. This is not an easy test; the best I've ever done on it is 497 out of a possible 500 points.

You show me someone whose only qualification to be answering questions on guns and shooting techniques is "used to wear a uniform," I can tell you, with absolutely no worries of being wrong, you're going to be hearing a lot of uninformed dogma masquerading as knowledge. You show me someone like Joe Porras, Wade's range manager and a retired 20-plus-year police veteran who can pass the SWAT instructor qual on demand, or Adam Simon, Sandbox vet and one of

the very few people working at Wade's to ever have passed the SWAT qual with a perfect 500-points score, we are talking a completely different sort of beast. These are guys who are gun people; they know firearms, they know how to shoot, they can answer your questions with good, hard, solid, well-considered, factual information.

So, **Piece of advice #6:** If possible, watch the people at the range shoot. Ask them if there's a match at the range that night. If not, when is the next one? Is anyone who works there, or even several someones, going to be running it/shooting in it? If the answer is no, that's a huge red flag. Can you attend the match just as an observer? Assuming they're squared-away, they'll probably say yes. At the match, watch those people shoot. Is your reaction, "Wow, that person is really good," or is it, "Damn, I've only been doing this for a few months and I'm better than them"? If you're going to trust someone to give you advice on guns, and shooting, make sure they're an actual gun person who knows how to shoot.

### APPEARANCE

Look over the facility. Is it clean? Is it well maintained by people who obviously take pride in their jobs? Or is it poorly lighted, dim, dirty? Is it well ventilated? When the ventilation fans are running, can you feel air moving over your skin, or do you find yourself thinking, "Are the fans on? Do they even HAVE fans?"

Is the range itself a large building, with lots of shooting bays, but still every bay is filled, and there are people waiting for a bay to open up? That might sound like a negative. It's not. Show me a huge facility that's insanely busy, I'll show you a place people enjoy going to shoot. Show me a little hole-in-the-wall shooting range with most of the bays unused, I'll show you a place where most people who ever shoot there never come back, because the experience was bad on any number of levels.

**Piece of advice #7:** Don't assume "gun range" and "shabby" are necessarily synonyms. They aren't. Appearance matters. Like a well-kempt personal appearance in a business setting denotes professionalism, a well-kempt facility indicates a professionally run gun range. And when it comes to size, and the number of people using the range: Size matters, and popularity counts.

### MATCHES

Ask if they host matches at the range. "No" is not an automatic disqualifier. "Yes" is a huge plus. I got my start in competition by shooting little local indoor range pistol matches. Fast-forward 20-some-odd years, I'm an IDPA Master class shooter and multi-time state champion. Wade's hosts Action Shooting International (ASI) matches. Actually, Wade's was where ASI started, literally the first range in the nation to have ASI matches. (A





**Inset:** Many indoor ranges have guns for rent, or their use might be free with a membership, an important resource to try-before-you-buy. **Large Photo:** Typically, an indoor range will be divided into lanes denoted by shooting booths, with bulletproof partitions between booths, each with its own mechanized target carrier.

few years later, there are ASI clubs in 13 states; good ideas do tend to spread.) They run matches Wednesday and Thursday, 7 PM to 9 PM, every two weeks. So I can go to the range early, shoot for a few hours, test out the latest article-assignment gun, do some personal practice, whatever, then shoot a match. For a guy like me, that's heaven.

**Piece of advice #8:** Ask if the range has a vigorous match schedule.

#### **DRAWING FROM THE HOLSTER & RAPID FIRE**

For so many of us, we're into guns largely because we carry them for self-defense. When we join a gun range, we want a place we can practice drawing from the holster, and firing at a pace appropriate for armed self-defense, i.e. fast. Many gun ranges, when you ask them about drawing from the holster and rapid fire, answer with, "Oh, we don't allow THAT."

When I was considering joining Wade's, I had the following conversation with Adam Simon.

Me: What's your policy on drawing from the holster, is there any sort of safety certification, any process I can go through to get cleared to do that on the range?

Adam: Yes, there is. Basically, you go out on the range with someone who works here, and we have you do two or three slow draws with an unloaded gun.

Then we have you do two or three draws at full-speed. We check to see if there are any safety issues. If there aren't, we go back out into the lobby, and we type into the computer, next to your name, "Good To Draw."

Me: How about rapid fire?

Adam: Our policy is: Keep all your rounds on the target. If you can do that, and you want to mag-dump as fast as you can pull the trigger, we're okay with it. We try to live by Big Boy Rules around here, as much as possible.

Me: I LIKE that policy.

**Piece of advice #9:** If you have a self-defense oriented mindset, ask if the range has a policy that allows drawing from the holster and rapid fire. Spend your money accordingly.

#### **RENTAL CASE**

Some, though by no means all, indoor ranges have a rental case full of handguns – and sometimes long guns up on the walls – you can try out to see if you like that particular firearm before forking over your money to find out you don't like it. Some ranges include free use of those guns as part of your membership. Wade's does, though they do require you buy the ammo there, since they don't want people blowing up their guns with unknown-quality ammo.

**Piece of advice #10:** Check whether or not the range has guns for rent, and whether or not their use is included in your membership fee.

#### **SUMMARY**

I hope all the foregoing can help guide people to avoid some of the common pitfalls encountered when taking the step from "shooter" to "gun range member." Enjoy the process, and good shooting!



## The Lever Loader

**T**he Speed Beez Lever Loader gives you the mechanical advantage you're looking for! Works with double-stack GLOCK 9mm mags with or without magazine extensions.

A must have for Pistol Caliber Carbines using GLOCK mags.

**P44-12337 \$24.95**



## Comp-Tac PCC PLM Mag Pouch



**T**he Comp-Tac Pistol Caliber Carbine Magazine Pouch – PLM – is an outside-the-waistband holder to carry a spare magazine for competition. The smooth, low-friction surface allows for a fast magazine removal and easy one-handed insertion of the magazine. "RH" pouches are designed to be worn on the left side, bullets forward; "LH" pouches on the right side, bullets forward.

Colt/UZI 9mm RH  
Colt/UZI 9mm LH  
CZ Scorpion LH  
GLOCK 9/40 RH  
SIG MPX LH

**P44-10047 \$37.99**  
**P44-10051 37.99**  
**P44-10053 37.99**  
**P44-10050 37.99**  
**P44-10052 37.99**

## Tuff Products Mag Pouches



**T**uff Products Magazine Pouches are the most versatile we've ever seen. They can be worn on a belt or attached to anything that has a MOLLE fastener system. Available in black or coyote brown.

Black 8-Magazine Single-Stack (1911) **P44-19854 \$39.95**  
Brown 8-Magazine Single-Stack (1911) **P44-19855 39.95**  
Black 5-Mag. Double-Stack (9/40 GLOCK) **P44-19856 39.95**  
Brown 5-Mag. Double-Stack (9/40 GLOCK) **P44-19857 39.95**

## Taylor Freelance Magazine Extensions



AR-15/Tavor 9mm SMG +10 **P44-12377 \$39.95**

This extension adds a full 10 rounds to your 32-round Colt SMG-type magazine. Works with many "stock" mag springs. *NOTE: Colt SMG mags come from many different manufacturers. Colt offered at least two major types – one where the floorplate slides on from the front, and the other which slides on from the rear. TF extensions are built to work with BOTH the front-mount and rear-mount styles.*

TF/Wolff Spring for above **P44-12213 \$10.00**

Some Colt/Tavor/UZI magazines ship with strong springs capable of powering +10 extensions. Others don't. This spring eliminates the problem.

CZ Scorpion +10 **P44-12378 \$49.95**

- Extra length/strength spring included
- Thumbscrew-and-gasket retention system allows for quick, easy disassembly.

GLOCK +20 *Pictured* **P44-12148 \$69.99**

Transforms Glock 31-round magazines into 51+1 round mags.

**Legal for PCC competition!**

- Extra length/strength spring included.

SIG MPX +10 **P44-12376 \$29.95**

- Works with stock mag spring.
- Angled floor stands the magazine straight up on a table for easier loading.

SIG P320 +5 **P44-12375 \$39.95**

- Extra length/strength spring included.

## California Competition Works Six-Magazine Pouch for PCC Magazines



**C**alifornia Competition Works' magazine storage pouch<sup>^</sup> for PCC magazines is the easy way to protect, store, organize and transport your PCC magazines. Easily holds six 30-round factory or after-market pistol-caliber carbine magazines.

**P44-39921 \$29.95**

# SAFARILAND Equipment Locking System

## ELS Quick Attachment Accessory System



Sorry, but the shotshells and magazine pictured do not come with these ELS System components.



2 ELS Attaching Forks  
P44-16685 \$20.00

2 ELS Receiver Plates  
P44-16686 \$20.00

2 Forks/2 Plates  
P44-15184 \$35.00

4-Shell Holder with ELS Attaching Fork (You'll need a Receiver Plate.)

4 Shell Holder P44-15181 \$58.00

8-Shell Holder with ELS Attaching Fork (You'll need a Receiver Plate.)

8 Shell Holder P44-15182 \$108.00

Mag Pouches (You'll need an Attaching Fork & Receiver Plate or other hardware.)

AR Mag Pouch P44-19396 \$19.95

M1A Mag Pouch P44-19397 19.95

# Tactical Shotshell Strippers



California Competition Works' Tactical Strippers are available in four- or six-shell versions that allow quick access to your shotgun reloads. Engineered to carry up to 3" magnum shells as well as the longer European shotshells. All CCW Tactical Strippers are equipped with a belt clip that will accommodate up to a 2-1/4" duty belt.

Six-Shell Tactical Stripper  
Four-Shell Tactical Stripper

P44-18606 \$23.95  
P44-18605 22.95

# 3 Gun Ammo Bags



TUFF Products 3 Gun Ammo Bags (Set of 3) are made of 1000 Denier Cordura® and equipped with dual 550 cord cinch strings for secure closure. The Red/Blue bags hold up to 200 loose pistol/rifle rounds and Black bag holds up to 200 loose shotgun rounds.

P44-15773 \$19.95

# Arredondo Accessories' Chamber Flags

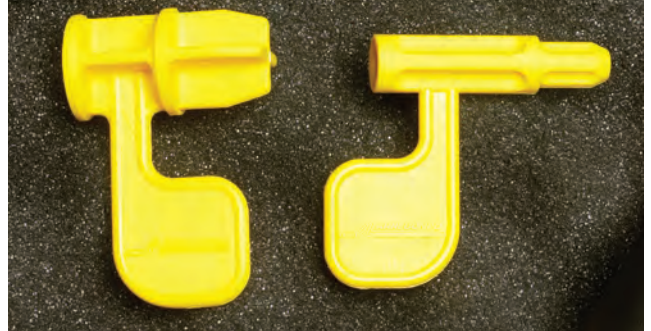

Made of tough nylon with a melting point of 480 degrees. Kit includes one shotgun chamber flag and one for your AR-15.

P44-15485 \$11.95

**WARNING:** The products offered for sale in this catalog can expose you to chemicals, including Lead, which are known to the State of California to cause cancer, birth defects or other reproductive harm. For more information, go to [www.P65Warnings.ca.gov](http://www.P65Warnings.ca.gov).

**Blue Press 51**

# REDDING Reloading Dies & Accessories



## Complete Three-die sets – Size, bell, seat

.32 ACP	P44-15521	\$106.00
.32-20 Winchester	P44-11906	106.00
.38-40 Winchester	P44-11838	140.00
.38-55 Win./Ballard	P44-19106	140.00
.44-40 Winchester	P44-11692	78.00
.45-70 Gov't	P44-12700	106.00
.460 S&W	P44-10319	106.00

## Complete Two-Die Sets

.204 Ruger	P44-12547	\$78.00
.22 Hornet	P44-11484	78.00
.220 Swift	P44-12182	78.00
.22-250	P44-15761	78.00
.224 Valkyrie	P44-10316	106.00
.243 Winchester	P44-15762	78.00
6mm Creedmoor	P44-10315	106.00
.25-06 Remington	P44-12183	78.00

.25 WSSM	P44-11194	82.35
.260 Remington	P44-09997	78.00
.270 Winchester	P44-10822	78.00
.270 WSM	P44-18337	47.95
6.5 Creedmoor	P44-71005	78.00
6.5 Grendel	P44-19893	140.00
6.5 x 55mm	P44-11353	78.00
6.8 SPC	P44-12548	106.00
7 x 57mm Mauser	P44-11212	78.00
7mm WSM	P44-18339	64.95
7mm Rem. SA UM	P44-18338	64.95
7mm Rem. Mag.	P44-11775	78.00
7mm-08 Remington	P44-12041	78.00
7.5mm Swiss	P44-09995	140.00
7.62 x 39mm	P44-12045	106.00
.30-30 Winchester	P44-29020	78.00
.30-40 Krag	P44-11835	140.00
7.62 x 54mm	P44-09994	106.00
.300 AAC Blackout	P44-12550	106.00
.300 WSM	P44-15763	78.00
.300 RUM	P44-18342	78.00
.300 Weatherby	P44-11354	78.00
.300 Win. Mag.	P44-12046	78.00
.303 British	P44-11691	106.00
8 x 57mm Mauser	P44-09996	78.00
.338 Win. Mag.	P44-11774	78.00
.338 Lapua Mag.	P44-21354	140.00
.458 S&COM	P44-10320	140.00

**Individual Dies: Neck-Size-Only Dies**

.223 Remington	P44-10164	\$53.00
.22-250	P44-11184	53.00

.224 Valkyrie	P44-10318	71.00
.243 Winchester	P44-10172	53.00
6mm Creedmoor	P44-10317	71.00
.25-06	P44-11336	53.00
.260 Remington	P44-09993	53.00
.270 Winchester	P44-11806	53.00
7mm Rem. Mag.	P44-11392	53.00
.308 Win./7.62	P44-10165	53.00
.30-06	P44-11763	53.00
.300 Win. Mag.	P44-11108	53.00



## Powder Measure,

### Reloading Accessories

Match-Grade Model 3 BR Powder Measure

P44-10121	\$184.00	
Large (7.5") Powder Reservoir	P44-10123	\$16.00
X-Large (10") Powder Reservoir	P44-10124	\$19.00
Powder Trickler	P44-11986	\$38.00
Stuck Case Removal Kit	P44-12186	\$28.00

## Specialty/Custom Die Sets<sup>▲</sup>

.50 AE	P44-14514	\$49.95
(Incl: RCBS steel size, expander, seat/crimp)		
.500 S&W	P44-11114	\$49.95
(Incl: RCBS steel size, expander, seat/crimp)		
RCBS Carbide .500 S&W Size Die only	P44-19923	\$40.95



## Lyman Neck Expander Die

Improves accuracy of cast and jacketed bullet reloads. Extends case life. A "Must-Have" die for the cast bullet or flat-base bullet user. The first step expands the inside of the case neck to just under bullet diameter for precise case neck tension in the finished reload. The second step expands the case mouth to bullet diameter or slightly over. This allows the jacketed or cast bullet to be started perfectly centered in the case mouth and

properly aligned with the axis of the case neck. By adjusting the plug slightly deeper, the second step also provides a slight flaring of the case mouth for reloaders using cast bullets.

.22 Caliber Neck	P44-48962	\$26.50
6mm Neck	P44-48966	26.50
6.5mm Neck	P44-48965	26.50
.30 Caliber Neck, Short	P44-48964	26.50
.30 Caliber Neck, Long	P44-48963	26.50



## Dillon's 1" Bench Wrench

A characteristic of virtually all progressive reloading machines, regardless of brand, is that the dies are set rather close together. When you're setting up a "naked" machine, there's plenty of room, but if you have a need to adjust a die afterward, it often requires a delicate touch to maneuver a lock ring on a crowded toolhead. We've addressed this in two ways. We offer 1" die lock rings and a 1" Bench Wrench to fit them. This combination gives much more room to re-adjust dies after they're already mounted. The opposite end of our 1" wrench is a 7/16" box-end for adjusting the Powder Bar of any Dillon Powder Measure. All our lock rings fit any standard 7/8" x 14 dies.

1" Die Lock Ring (Zinc Alloy)	P44-14067	\$1.75
5-Pack of Die Lock Rings (Zinc)	P44-10669	5.50
1" Dillon Bench Wrench	P44-10842	8.95
(Buy two or more 1" Bench Wrenches for \$8.10 each)		
Wrench/Zinc Lock Ring 5-Pack	P44-10668	10.95
<b>New Steel 1" Die Lock Rings</b>		
1" Die Lock Ring (Steel)	P44-62422	\$2.25
5-Pack of Die Lock Rings (Steel)	P44-62423	8.95
10-Pack of Die Lock Rings (Steel)	P44-62424	14.95
Wrench/Steel Lock Ring 5-Pack	P44-62425	17.95

## L. E. Wilson Case Gages, Deburring Tool

.22-250	P44-12718	\$38.00
.243	P44-12828	38.00
.25-06	P44-11760	38.00
.270	P44-11828	38.00
6mm/6.5mm Creedmoor	P44-12108	38.00
6.8 SPC	P44-19522	38.00
7mm Mag.	P44-12336	46.00
7.62x39	P44-14901	38.00
.30-30	P44-12924	38.00
.300 AAC Blk.	P44-19515	38.00
.300 Win. Mag.	P44-11752	46.00
.300 WSM	P44-18709	38.00
.357 SIG	P44-18708	38.00
.38-40 Win.	P44-10682	38.00
.44-40 Win.	P44-10697	38.00
.50 BMG	P44-14447	60.00
Deburring Tool	P44-16038	26.00



## EGW Chamber Checkers

<b>Rifle Chamber Checkers</b>		
.223 Rem.	P44-25377	\$29.95
5.56x45	P44-25376	29.95
6.5 Creedmoor		
.300 Blk	P44-11582	29.95
.308 Win.	P44-11581	29.95
.30-06	P44-18964	39.95
	P44-19675	45.00
<b>Pistol Chamber Checkers</b>		
9mm	P44-19846	\$19.95
.38 Super	P44-19847	19.95
.40 S&W	P44-19848	19.95
10mm	P44-19676	20.00
.45 ACP	P44-19849	19.95
<b>Shotgun Chamber Checker</b>		
12 Ga.	P44-19523	\$49.99
20 Ga.	P44-19524	49.99
<b>Cowboy Chamber Checker</b> (.357 Mag., .44 Mag., .44-40, .45 Colt)	P44-25375	\$19.95

# Dial Caliper<sup>^</sup>

This dial caliper is made of hardened stainless steel and features a covered track that keeps chips out for longer life. The measuring faces are hardened, ground and lapped. The large, adjustable dial is easily read to .001 inch and measures .100 per revolution. Features a no-glare satin chrome finish.

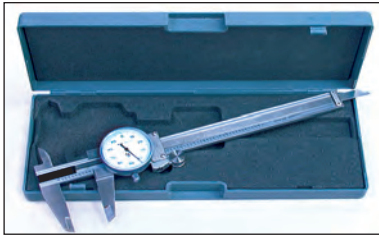

**P44-13462 \$28.00**



# Digital Caliper<sup>^</sup>

Accurate, Easy to Read!

**P44-17171 \$39.95**

# Lyman Products



Lyman's Precision Funnel Set is the ideal system for the serious reloader. The Precision Funnel Set is made to be completely static free, with a body of die-cast aluminum and precision-turned aluminum inserts. This is no "one size fits all" funnel; the Precision Funnel Set uses precision-machined, caliber-specific inserts to properly fit the case neck. The inserts can be quickly and easily installed by simply pushing them into place and then pulling them out when changing calibers. The Precision Funnel Set also comes with a padded storage case that neatly stores extra inserts when not in use. The set includes inserts for .22, .243/6mm, .25/6.5mm, .270/7mm, .30 and .338 caliber rifle cartridges.

**P44-11389 \$39.95**



Lyman Scale Weight Check Sets enable you to check/calibrate your scale using known weights.

Weight Set .5 - 60.5 Gr.  
Weight Set .5 - 210.5 Gr.

**P44-15958 \$36.95**  
**P44-15959 48.95**

# CED Ultimate Pro Powder Trickler



- Adjustable height
- Weighted base
- Extension arm

**\$21.95**  
**P44-10940**

# Lyman Powder Pal Funnel Pan



**P44-18399 \$5.95**

# Kershaw<sup>®</sup>

TRUST YOURSELF. TRUST YOUR TOOLS. BE READY FOR EVERYTHING.



Kershaw Volt II opens one-handed and with an authoritative "twack" thanks to Kershaw's SpeedSafe<sup>®</sup> assisted opening system. A simple pull back on the flipper and the Volt II opens smoothly and easily.

Blade length: 3.25" Closed: 3.9" Open: 7.1"

**P44-66698 \$55.95**



Designed by RJ Martin, the Volt II has the same versatile blade and handle style as the original Volt, but with a hardworking 8Cr13MoV stainless steel blade and textured, black glass-filled nylon scales.

Blade length: 3.25" Closed: 3.9" Open: 7.1"

**P44-66699 \$49.95**



The Kershaw Method opens quickly, easily, and manually with Kershaw's KVT ball-bearing system and a built-in flipper. The handle is black - of course. The G10 handle features an unusual machined pattern reminiscent of an architectural truss.

Blade length: 3" Closed: 4.25" Open: 7.25"

**P44-66700 \$39.99**



Kershaw Pub looks like nothing you've ever seen. The blade is a modified sheep'sfoot with a straight edge and clipped rather than rounded tip.

Blade length: 1.6" Closed: 3.1" Open: 4.5"

**P44-31323 \$24.95**

# Comtech's STINGER



THE STINGER: Comtech's own personal defense device. Designed to act as a "force multiplier," it's like having the punching power of a karate master - instantly! There's really nothing like it for easy carry and access. It passes un-noticed by 90 percent of people who see it. Yup, just another "keychain device" to most, and yet it works so well when needed. You deserve a Stinger!

**P44-19495 \$9.95**

# The Original GLOCK<sup>®</sup> Field Knife

Field Knife, GLOCK, with scabbard, 1 ea.

**P44-15483 \$34.95**



**^ WARNING:** The products offered for sale in this catalog can expose you to chemicals, including Lead, which are known to the State of California to cause cancer, birth defects or other reproductive harm. For more information, go to [www.P65Warnings.ca.gov](http://www.P65Warnings.ca.gov).

**Blue Press 53**

# MAGPUL®

## UNFAIR ADVANTAGE™



MAGPUL 10-Round polymer  
PMAG 10 AR-15/M4 Gen  
M3™ .223/5.56 magazine.  
P44-33393 \$13.95



MAGPUL 25-Round polymer  
PMAG 25 LR/SR Gen M3™  
Window SR25/ M110 .308/  
7.62x51 magazine.  
P44-27080 \$22.95



MAGPUL 30-Round polymer  
PMAG 30 AK/AKM MOE®  
7.62x39 magazine.  
P44-43241 \$13.95

MAGPUL 30-Round polymer  
PMAG 30 GEN M3™ AR-  
15/M4 .223/5.56 magazine.  
P44-43280 \$14.95  
MAGPUL AR-15/M4  
.300 BLK magazine  
P44-12121 \$15.95



MAGPUL -5 Round Limiter  
PMAG 20. Only fits  
.223/5.56 magazines.  
P44-33394 \$13.95 Pkg of 3



MAGPUL's Enhanced Self Lev-  
eling Follower is a drop-in  
replacement for USGI 30-round  
magazines. Features a four-way  
anti-tilt design.  
3-Pk. P44-12606 \$6.95



MAGPUL MAGLINK™  
makes it easy to link  
MagPul .223/5.56 mags together.  
P44-43240 \$17.95  
**FOR MAGPUL  
.223/5.56 MAGS ONLY**

MAGPUL 20-Round polymer  
PMAG 20 LR/SR Gen  
M3™ SR25/M110 .308/ 7.62x51  
magazine. P44-55007 \$19.95

MAGPUL 20-Round polymer  
PMAG 20 AK/AKM MOE®  
7.62x39 magazine. P44-10008 \$12.95



MAGPUL Bipod for 1913 Picatinny Rail is made of high-strength  
polymer, steel and Mil-Spec hard anodized aluminum.  
Flat Dark Earth P44-12112 \$109.95  
Black P44-12098 109.95



MAGPUL 1911 Grip Panels feature reinforced polymer  
construction and a unique diamond-shaped cross section to  
prevent twisting in the hand. They also have an aggressive mag-  
release cut out and are compatible with ambidextrous safeties.

Flat Dark Earth P44-43237 \$19.95  
Black P44-43236 19.95  
Olive Drab Green P44-43238 19.95

# MAGPUL Magazines for GLOCK® Pistols



The PMAG® 15 GL9™, PMAG® 17 GL9™, PMAG® 21 GL9™ and PMAG® 27 GL9™ magazines hold 15, 17, 21 and 27 9mm Parabellum rounds respectively. *Note: Will not accept aftermarket floorplates designed for GLOCK® factory magazines. Instead, MagPul offers the GL L-PLATE™* Overmolded extension for GL9™ pattern PMAGs®. *Note: Does not increase capacity.*

PMAG 17 GL9	P44-43287	\$12.95
PMAG 15 GL9	P44-20950	12.95
PMAG 21 GL9	P44-43399	17.95
PMAG 27 GL9	P44-12096	19.95
GL L-PLATE 3-Pack	P44-20929	19.95

# SPRINGFIELD Magazines/1911 Guide Rod



<b>Springfield XD &amp; XDM Magazines</b>		
12-Rd. XD .40	P44-11587	\$31.95
13-Rd. XD Comp. 9mm	P44-11765	29.95
9-Rd. XD Comp. .45	P44-11764	29.95
13-Rd. XD/XDM .45	P44-11585	32.95
19-Rd. XDM 9mm	P44-15496	36.95
7-Rd. XD-S 9mm	P44-19681	28.95
8-Rd. XD-S 9mm	P44-11731	39.95
9-Rd. XD-S 9mm	P44-19680	39.95
16-Rd. XDM .40	P44-19971	36.95
5-Rd. XD-S .45	P44-15234	28.95
6-Rd. XD-S .45	P44-11730	39.95
7-Rd. XD-S .45	P44-15235	39.95
<b>Two-Piece 1911 Recoil Spring Guide Rod – Machined from stainless steel.</b>		
	P44-15724	\$24.95



**G**LOCK factory magazines.  
G-17  
P44-11363 \$39.95  
33-Rd. 9mm  
P44-18806 \$39.95



**C**-Products 32-Rd. 9mm M-16/AR-15 magazines. .  
P44-49996 \$29.95



**C**-Products 30-Round aluminum M-16/AR-15 magazine.  
P44-15593 \$19.95

# Mec-Gar Pistol Magazines

<b>NEW Plus-2 Adapter, fits mags in red</b>	P44-62207	\$9.95
Beretta 92 18-rd. AFC*	P44-18728	25.95
Beretta 92 20-rd. AFC*	P44-18729	29.95
Browning HP 15-rd. Blue	P44-18730	25.95
1911 8-rd. .45 ACP Blue	P44-43406	25.95
1911 8-rd. .40 S&W Blue	P44-43405	24.95
1911 8-rd. 10mm Blue	P44-43404	24.95
1911 10-rd. 9mm Blue	P44-43402	29.95
1911 11-rd. .45 ACP Blue	P44-18732	24.95
<b>CZ-75B 19-rd. AFC*</b>	P44-14989	29.95
Para P-14 14-rd. Blue	P44-18733	23.95
Para P-16 15-rd. Blue	P44-18734	23.95
Para P-18 17-rd. Blue	P44-18735	23.95
Ruger P-Series 9mm 17-rd. Blue	P44-18736	25.95
Ruger P-Series 9mm 20-rd. Blue	P44-18737	29.95
S&W 59 17-rd. Blue	P44-18738	25.95
S&W 59 20-rd. Blue	P44-18739	29.95
<b>SIG Sauer 226 18-rd. AFC*</b>	P44-18740	25.95
SIG Sauer 228 15-rd. Blue	P44-18741	25.95
Springfield XD (not XDM) .40 13-rd. AFC*	P44-14991	29.95
Taurus 92-99 17-rd. Blue	P44-18742	25.95
Taurus 92-99 18-rd. AFC*	P44-14987	23.99
Taurus 92-99 20-rd. Blue	P44-18743	29.95
<b>*AFC = Anti-Friction Coating</b>		

# CMC Magazines

**M**McCormick Railed Power Mags™ feature patent pending Dual Wall Feed Rails™ that are at least twice the strength of regular feed lips. They have a patented tactical RPM™ follower, a stainless steel mag tube, an EZ clean base pad and a proven customer-satisfaction policy. All CMC magazines are designed to give the pistol shooter the advantage of extra shot capacity and improved performance.



<b>Railed Power Mags™</b>		
CMC RPM 10-Rd. .45 ACP 1911	P44-11077	\$39.95
CMC RPM 8-Rd. .45 ACP 1911	P44-11078	36.95
<b>XP Series, Match Grade and Power Mag+ Magazines</b>		
Match Grade .45 ACP 8-Rd. (Floorplate drilled for base pads.)		
	P44-10311	\$30.99
Power Mag+.45 ACP 10-Rd.	P44-15025	34.99
Extra XP-9 Base Pad	P44-43300	4.99

# ADCO Super Thumb

**A**DCO SUPER THUMB® offers models for popular centerfire pistols and 10/22 style magazines. ST1 is for 9mm and .40 caliber Beretta, Browning, Ruger, SIGARMS, S&W, etc. In addition, the ST1 has interior rails and grooves to accommodate Colt Government magazines.



ST1 is for 9mm and .40 caliber Beretta, Browning, Ruger, SIGARMS, S&W, etc. In addition, the ST1 has interior rails and grooves to accommodate Colt Government magazines.	P44-18607	\$10.95
ST2 is for GLOCK and Para-Ordnance magazines.	P44-18608	\$10.95
ST3 handles virtually all centerfire, single-column magazines.	P44-18609	\$10.95
ST22 is for Ruger 10/22 rifles.	P44-18610	\$10.95
STJR is for Ruger, Browning, Colt and High Standard .22 pistols.	P44-18611	\$3.50

**WARNING:** The products offered for sale in this catalog can expose you to chemicals, including Lead, which are known to the State of California to cause cancer, birth defects or other reproductive harm. For more information, go to [www.P65Warnings.ca.gov](http://www.P65Warnings.ca.gov).

# Elite Tactical Systems Magazines & Loaders

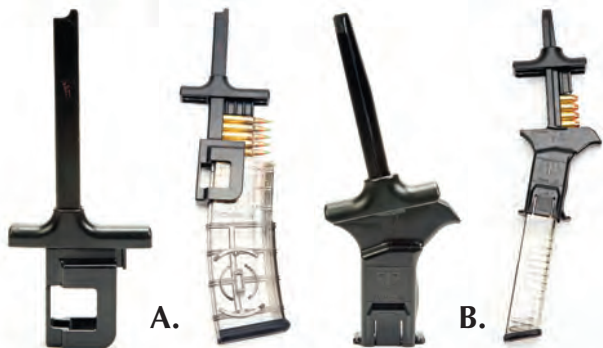

Elite Tactical Systems' C.A.M. Rifle Magazine Loader loads AR15, AK47, AK74, FN SCAR-16/17, AR10, G36, Steyr AUG, MP5, CZ Scorpion EVO, Colt SMG, UZI and more in 5.56x45/.223, 7.62x51/.308, 7.62x39, .300BLK, 5.45x39, 9mm and more.

The ETS C.A.M. Pistol Magazine Loader loads most 9mm or .40 caliber pistol magazines – including single stacks. It doesn't force rounds through the feed lips, so it won't damage magazines.

Both ETS C.A.M. magazine loaders will lift up to 10 rounds of ammo directly from an ammo tray!

ETS 30-round AR magazines have a built-in coupler that allows multiple magazines to be connected in seconds with no tools. Clip-on dust covers keep dirt and debris out during storage.

ETS magazines for GLOCK® pistols are compatible with aftermarket floorplates for GLOCK magazines, feature special grip ribs on the floorplate to aid in extraction and are easy to disassemble for cleaning and maintenance.

## Made in USA With a Lifetime Warranty!

A. C.A.M. Rifle Mag. Loader	P44-10244	\$29.99
B. C.A.M. Pistol Mag. Loader	P44-10245	29.99
C. AR Magazine, 30 rd.	P44-10266	19.99
D. GLK-18 Magazine, 31 rd. 9mm	P44-10246	21.99
GLK-17-10 Magazine, 10 rd. 9mm	P44-10265	17.99
GLK-19-10 Magazine, 10 rd. 9mm	P44-10264	17.99
GLK-22 Magazine, 30 rd. .40 S&W	P44-10250	21.99
GLK-42 Magazine, 7 rd. .380	P44-10251	16.99
GLK-42 Magazine, 9 rd. .380	P44-10260	21.99
GLK-42 Magazine, 12 rd. .380	P44-10261	21.99
GLK-43 Magazine, 7 rd. 9mm	P44-10247	16.99
GLK-43 Magazine, 9 rd. 9mm	P44-10248	21.99
GLK-43 Magazine, 12 rd. 9mm	P44-10249	21.99

## Arredondo Accessories Magazine-Cleaning Brush



Arredondo Accessories' Magazine-Cleaning Brush is ideal for that little job we all dread (avoid?)! No excuse, Sir! P44-19257 \$11.95



The new ETS magazine fits the H&K MP5, MP5K, HK94, SP89 and the SP5K. It works with the ETS C.A.M. Rifle Magazine Loader. It's extremely reliable feeding – even with hollow points. They're far lighter than steel magazines, fits standard MP5 mag pouches and couplers. Both 30- and 40-round capacity available. Compatible with all MP5-style 9mm firearms such as: Zenith, MKE, Omega, POF, HK Contract MP5 9mm Variants, MP5 style SW5, BW5, CA94, D54, V94, clones or other custom builds.

HK MP5 Magazine, 30 rd. 9mm	P44-10043	\$39.99
HK MP5 Magazine, 40 rd. 9mm	P44-10042	44.99

## Wilson Combat

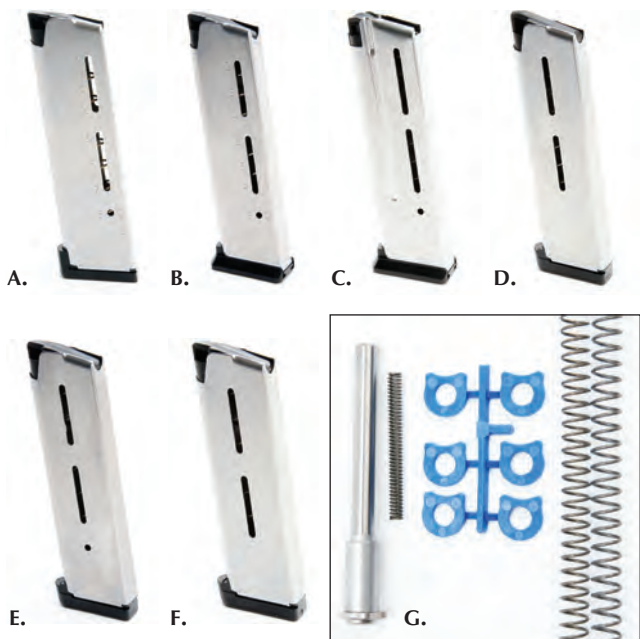

Wilson Combat's Elite Tactical Magazine HD +P – "The ETM Heavy Duty/+P rated .45 ACP magazines with exclusive stainless flatwire MAX magazine spring and time-tested ETM tube."

A. (8 rd) .45ACP	P44-18602	\$44.95
------------------	-----------	---------

Elite Tactical Magazine – "The ETM started with a blank sheet of paper and 30-plus years of 1911 and 1911-magazine experience; designed from the ground up as a premium tactical magazine."

B. ETM (8 rd) .45ACP	P44-12027	\$34.95
C. ETM (10 rd) 9mm	P44-19463	\$34.95

Wilson Combat Magazines – "No other .45 magazine on the market can compare for proven inherent reliability, durability and the ability to remain fully loaded for long periods of time without damage."

D. Match Magazine (7 rd) .45ACP	P44-10505	\$32.95
E. WIL-ROG Mag (8 rd) .45ACP	P44-11714	32.95
F. Officers Match Mag. (7 rd) .45ACP	P44-10506	32.95

SHOK-BUFF® Recoil System – Includes a One Piece Guide Rod and Plug; six SHOK-BUFF buffers; an Extra Power Firing Pin Spring; an Extra Power Recoil Spring; and a Reduced Power Recoil Spring.

G. SHOK-BUFF System	P44-18150	\$37.05
---------------------	-----------	---------

Wilson SHOK-BUFF® – A 1/10" thick poly fiber buffer between the frame and slide contact areas.

SHOK-BUFF Kit (2 buffers, 18.5# recoil spring) Gov't Model	P44-18148	\$5.95
SHOK-BUFF Buffer only (6 ea.)	P44-18147	\$6.95



# Ed Brown Products

**Two-Piece 1911 Guide Rod Assembly**  
Heat-treated Stainless Steel  
May be installed without firearm modification.  
P44-10229 \$29.95



**Rebuild Kit**  
for 1911-Style Pistols,  
STAINLESS (pictured)  
P44-10226 \$19.95  
BLUE  
P44-10225 \$19.95

**Grip Screw Bushings**  
Set of Four for  
1911-Style Pistols  
STAINLESS (pictured)  
P44-10228 \$7.95  
Set of Four for  
1911-Style Pistols  
BLUE  
P44-10227 \$6.95



## Wolff Gunsprings



Wolff RECOIL SPRINGS				
<b>BROWNING HI-POWER</b>				
18.5 Pound	P44-11373	\$7.25	14 Pound	P44-19357 7.98
			15 Pound	P44-19358 7.98
			16 Pound (Std.)	P44-19359 7.98
<b>COLT GOVERNMENT MODEL</b>			<b>SPRINGFIELD 5" 9/40 XD</b>	
9 Pound	P44-11719	\$7.25	12 Pound	P44-19339 \$7.98
10 Pound	P44-12193	7.25	13 Pound	P44-19340 7.98
12 Pound	P44-12007	7.25	14 Pound	P44-19341 7.98
13 Pound	P44-12443	7.25	15 Pound	P44-19342 7.98
14 Pound	P44-12338	7.25	16 Pound	P44-19343 7.98
16 Pound (Std.)	P44-11860	7.25	17 Pound (Std.)	P44-19344 7.98
17 Pound	P44-12192	7.25	<b>SPRINGFIELD 5" 45 XD</b>	
18.5 Pound	P44-12465	7.25	14 Pound	P44-19345 \$7.98
20 Pound	P44-12056	7.25	16 Pound	P44-19346 7.98
23 Pound	P44-11377	7.25	18 Pound	P44-19347 7.98
<b>COLT OFFICERS MODEL</b>			<b>SPRINGFIELD 4.5" 9/40 XDM</b>	
24 Pound	P44-12110	\$7.25	14 Pound	P44-19336 \$7.98
<b>CZ 75B</b>			16 Pound	P44-19337 7.98
9 Pound	P44-19348	\$7.98	18 Pound (Std.)	P44-19338 7.98
10 Pound	P44-19349	7.98	<b>Wolff GUIDE RODS</b>	
11 Pound	P44-19350	7.98	S&W M&P	P44-19354 \$24.95
12 Pound	P44-19351	7.98	Sp'field XDM 4.5	P44-19355 24.95
13 Pound	P44-19352	7.98	<b>Wolff HAMMER SPRINGS</b>	
14 Pound (Std.)	P44-19353	7.98	1911	P44-11511 \$9.00
<b>SMITH &amp; WESSON M&amp;P</b>			<b>Wolff MAG CATCH SPRINGS</b>	
12 Pound	P44-19356	\$7.98	1911	P44-11791 \$9.95

## Adjustable Target Pistol Sight



This **Adjustable Target Pistol Sight** is precision machined and fits in a standard 1911 "Bomar slide cut." Yeah, the services of a gunsmith are required to cut the slide (unless your pistol already has a Bomar cut) but the results are worth it.

P44-18210 \$53.95

## Evolution Gun Works 1911 Magwell



EGW 1911 Magwell, Blue  
EGW 1911 Magwell, Stainless

P44-18601 \$74.99  
P44-18600 74.99

## Dillon's 1911 Action Impact Reducers<sup>^</sup>



An easy, affordable way to protect your favorite 1911's frame from being battered by recoil.

Action Impact Reducers (6 ea.)

P44-20516 \$4.95



## Dillon Bushing Wrench

Metalfom 8-Round 10mm  
1911 pistol magazine.

P44-33328 \$24.95

P44-11049 \$2.50

**WARNING:** The products offered for sale in this catalog can expose you to chemicals, including Lead, which are known to the State of California to cause cancer, birth defects or other reproductive harm. For more information, go to [www.P65Warnings.ca.gov](http://www.P65Warnings.ca.gov).

**Blue Press 57**

The new  
Super Vel.  
Hotter.  
Faster.  
Better.



The original Super Vel Cartridge Company forever changed "police ammunition" with a new style of bullet, the jacketed hollow point. Now, 40 years later, Super Vel is back!

**Super Vel Ammunition**

.38 Sp. +P "Super Snub" 90 Gr. JHP (20)	<b>P44-10024</b>	<b>\$22.95</b>
.380 ACP "Pocket Rocket" 80 Gr. SCHP (20)	<b>P44-10270</b>	<b>24.95</b>
9mm +P 115 Gr. SCHP (20)	<b>P44-12881</b>	<b>27.95</b>
9mm 115 Gr. Subsonic SCHP (20)	<b>P44-12883</b>	<b>27.95</b>
10mm 160 Gr. SCHP (20)	<b>P44-12886</b>	<b>39.95</b>
.45 ACP +P 160 Gr. SCHP (20)	<b>P44-12880</b>	<b>39.95</b>

**Baschieri & Pallagri Slugs**



**\$23.95**  
**P44-19214**

Reduced recoil,  
1200 fps 25 per  
box.  
NOTE: Age  
verification  
required to  
order.

**Lone Wolf Distributors Parts  
for GLOCK® Firearms**

**BUTTON RIFLED, THREE-STAGE HONED BORE**



**Lone Wolf Distributors' AlfaWolf Replacement Barrels**

GLOCK 17 9mm Barrel (Black)	<b>P44-43350</b>	<b>\$139.95</b>
GLOCK 19 9mm Barrel (Black)	<b>P44-43352</b>	<b>139.95</b>
GLOCK 26 9mm Barrel (Black)	<b>P44-43361</b>	<b>139.95</b>

**DESIGNED FOR LEAD, PLATED, OR JACKETED AMMUNITION**



**Lone Wolf Distributors' AlfaWolf Threaded Replacement Barrels (Thread Protectors ARE included)**

GLOCK 22/31 9mm Conv. 1/2"x28 Bbl.	<b>P44-43357</b>	<b>159.95</b>
GLOCK 23/32 9mm Conv. 1/2"x28 Bbl.	<b>P44-43360</b>	<b>159.95</b>

All AlfaWolf barrels are proudly made in the USA.



**Lone Wolf Distributors' Slide-Completion Kit**

9mm GLOCK	<b>P44-43367</b>	<b>\$84.95</b>
10mm GLOCK	<b>P44-43364</b>	<b>84.95</b>
.45 ACP GLOCK	<b>P44-43365</b>	<b>84.95</b>



**Lone Wolf Distributors' Parts:**

Extended Mag Release (Small Frame)	<b>P44-18569</b>	<b>\$9.95</b>
Extended Mag Release (Large Frame)	<b>P44-19115</b>	<b>4.99</b>
Extended Take-Down Lever	<b>P44-19114</b>	<b>9.95</b>
3.5# Trigger Stop Connector	<b>P44-16501</b>	<b>14.95</b>
3.5# Trigger Stop Connector for G42/G43	<b>P44-10111</b>	<b>19.99</b>
Extended Slide Stop	<b>P44-22299</b>	<b>15.99</b>

**GLOCK® Factory Original Parts:**

Extended Slide Release	<b>P44-18570</b>	<b>\$19.95</b>
Striker Cups (The ones you always lose.)	<b>P44-19325</b>	<b>4.95</b>
Striker Channel Liner	<b>P44-18881</b>	<b>9.95</b>

**Wolff Spring Co. Parts for GLOCK firearms:**

Competition Spring Set	<b>P44-11524</b>	<b>\$9.95</b>
Trigger Return Spring 3-Pack	<b>P44-11818</b>	<b>7.99</b>
X-Tra Power Trigger Rtn. Spr. 3-Pk.	<b>P44-15558</b>	<b>7.99</b>
Guide Rod, GLOCK 17, 22, 31	<b>P44-11356</b>	<b>24.95</b>
Guide Rod, GLOCK 19, 23	<b>P44-11435</b>	<b>24.95</b>
Guide Rod, GLOCK 20, 21	<b>P44-11352</b>	<b>24.95</b>
Recoil Spring, 12#	<b>P44-11420</b>	<b>7.99</b>
Recoil Spring, 14#	<b>P44-11418</b>	<b>7.99</b>
Recoil Spring, 15#	<b>P44-11419</b>	<b>7.99</b>

# Apex Tactical Specialties



**S&W SD Polymer  
Action Enhancement Trigger**  
P44-77789 \$39.95



**S&W M&P Pistol Sear**  
M&P 9/40 P44-21889 \$41.95  
M&P 45 P44-21892 \$41.95



**S&W M&P 9/40  
Competition Spring Kit**  
P44-21891 \$25.95



**S&W M&P 9/40  
Ultimate Striker Block Kit**  
P44-21890 \$35.95

**S&W Sigma  
Spring Kit**  
P44-77788 \$20.95



# Pearce Grip, Inc. Grip/Magazine Extensions



*Grip extensions do not alter mag. capacity.*

GLOCK® 26/27	<b>P44-10346</b>	<b>\$9.95</b>
G29 (10 rd./30 (9 rd. opt. mag.))	<b>P44-10355</b>	<b>9.95</b>
G30 (10 rd. mag. only)	<b>P44-10356</b>	<b>9.95</b>
G42	<b>P44-10583</b>	<b>9.95</b>
G43	<b>P44-10584</b>	<b>9.95</b>
Kel-Tec P11/Taurus PT111	<b>P44-18586</b>	<b>9.95</b>
SIG P365	<b>P44-11802</b>	<b>9.95</b>
S&W M&P SHIELD™	<b>P44-11782</b>	<b>9.95</b>
Springfield XD (9mm/.40 only)	<b>P44-18587</b>	<b>9.95</b>
Springfield XD-S	<b>P44-15286</b>	<b>9.95</b>

*Mag. extensions add additional capacity.*

GLOCK® 10mm/.45 ACP (+2)	<b>P44-18589</b>	<b>9.95</b>
G27/33 (+1)	<b>P44-18590</b>	<b>9.95</b>
G42 (+1)	<b>P44-10585</b>	<b>9.95</b>
G43 (+1)	<b>P44-10586</b>	<b>9.95</b>

# “The Plug” GRIP PLUG FOR GLOCKS



## For Pre-Gen 4 GLOCKS

GLOCK® Models 17, 19,20,21,22,23 (fit may vary)	<b>P44-18161</b>	<b>\$7.95</b>
Model 21SF	<b>P44-19925</b>	<b>7.95</b>
Models 26,27,33	<b>P44-10235</b>	<b>7.95</b>
Model 30	<b>P44-10648</b>	<b>7.95</b>

## For Gen 4 GLOCKS w/o Backstrap

Models 17, 18,19,22,23,24,25,31,32,34,35	<b>P44-12179</b>	<b>\$7.95</b>
Models 20,21,41	<b>P44-12180</b>	<b>7.95</b>
Models 26,27,33	<b>P44-60900</b>	<b>7.95</b>
Models 42,43	<b>P44-60899</b>	<b>7.95</b>

# The National Target Company, Inc.



**Pistol Targets: 100 per package**

NRA Paper D-1 "Tombstone" Target 23"x35"	<b>P44-18388</b>	<b>\$44.00</b>
IDPA Paper Practice Target 22"x34"	<b>P44-15735</b>	<b>39.95</b>
USPSA/IPSC Paper Practice Target 22"x35"	<b>P44-15836</b>	<b>39.95</b>
50 Foot TIMED/RAPID FIRE 10.5"x12"	<b>P44-15832</b>	<b>12.00</b>
Competition 50 Foot SLOW FIRE 10.5"x12"	<b>P44-15831</b>	<b>12.00</b>
Competition 25 Yard SLOW FIRE 10.5"x12"	<b>P44-13096</b>	<b>12.00</b>
High Visibility Green 25 Yard SLOW FIRE 10.5"x12"	<b>P44-66703</b>	<b>14.00</b>
Police B-34 (Silhouette) 25 Yard 14"x24"	<b>P44-13163</b>	<b>17.00</b>
B-34 High Visibility Green 25 Yard 14"x24"	<b>P44-66704</b>	<b>20.50</b>
Police BH-21 (Silhouette) 25 Yard 22.5"x35"	<b>P44-10094</b>	<b>37.00</b>
Competition 25 Yard RAPID FIRE 21"x24"	<b>P44-12839</b>	<b>24.00</b>
Competition 50 Yard SLOW FIRE 21"x24"	<b>P44-10041</b>	<b>24.00</b>
Police B-27 (Silhouette) 50 Yard 22.5"x35"	<b>P44-10670</b>	<b>37.00</b>

**Rifle Targets: 100 per package**

Small Bore Rifle 100 Yard 14"x14"	<b>P44-12430</b>	<b>\$11.00</b>
High Power 200 Yd. 21"x24" (600 Yd. reduced)	<b>P44-12650</b>	<b>46.00</b>

ST-4 100 Yard Precision Rifle Target 15"x17" **P44-13679** **16.00**

**Replacement Center 100 per package**

Pistol 25 Yard B8P Repair Center 10.5"x10.5"	<b>P44-12676</b>	<b>\$7.00</b>
200 Yard Rifle Repair Center 12.75"x12.75"	<b>P44-15830</b>	<b>20.00</b>

**See Hit Targets 12 per package**

SH-B8CRC Pistol 25 Yard Repair Center 10"x10"	<b>P44-16328</b>	<b>\$9.00</b>
SH-H-1 8 Inch Sighting Target 10"x10"	<b>P44-16329</b>	<b>9.00</b>

**Target Pastors**

Black, Self-Adhesive, 500 ea.	<b>P44-16304</b>	<b>\$3.50</b>
Buff, Self-Adhesive, 500 ea.	<b>P44-16309</b>	<b>3.50</b>
Brown, Self-Adhesive, 500 ea.	<b>P44-16310</b>	<b>3.50</b>
White, Self-Adhesive, 500 ea.	<b>P44-16313</b>	<b>3.50</b>
Orange, Self-Adhesive, 500 ea.	<b>P44-16327</b>	<b>3.50</b>

# Hartman Mfg Target Stands



One Target Stand	<b>P44-18237</b>	<b>\$49.95</b>
A Pair of Stands	<b>P44-74493</b>	<b>91.95</b>



One Hostage Target Adapter (Shown at right attached to Target Stand – not included. Works only with Hartman target stands.) **P44-11697** **\$26.99**

A Pair of Target Spikes **P44-11393** **\$26.99**

# The HMB Bolt



Young Manufacturing is the licensed manufacturer of the HMB bolt. The HMB Bolt by HM Defense eliminates the pass-through cam-pin hole and replaces it with a cam-pin socket and radiused cam-pin design. The new patented design eliminates the natural weak point of Mil-Spec bolts by significantly increasing the amount of metal (and strength) at the cam-pin location. The result: **NO MORE BROKEN BOLTS!** The HMB Bolt also reduces contact between cam pin and firing pin, enabling smoother operation of the firing pin, bolt lugs and aft gas rings. The new cam-pin socket also retains lubrication for extended operations. Comes with a phosphate cam pin.

HMB Bolt **P44-66680 \$99.00**



Young Manufacturing's **Upper Receiver Vise** holds any AR15 upper receiver regardless of the manufacturer. Since it supports the receiver from the inside, the outside dimensions are of no concern. Made from aircraft-grade 6061 T6 aluminum and anodized to MIL-A-8625 Type 3 Class 2.

YM Upper Receiver Vise **P44-66679 \$34.99**



This tool makes it simple to remove or install a new ejector and spring into the AR-15 bolt. Anyone who has tried to do this without a tool will be amazed at the reduction in the number of cuss words needed to perform the task. Comes with alignment and roll pin punch.

YM Bolt Assembly Tool **P44-66678 \$39.95**

# Jerry Miculek AR-15 Compensator



Jerry Miculek's three-chamber AR-15 Compensator fits threaded-barrel rifles and may be "clocked" for left- or right-handed shooters. Used by many top 3-gun competitors.

**P44-11328 \$49.95**

# JP Enterprises Tactical Performance Gear



**JP Enterprises (Competition Only)**  
**Low Mass Buffer JPLMB**  
**P44-12585 \$59.95**



**JP AR Speed Hammer**  
**JPSH-1A Low Mass Hammer**  
**P44-12617 \$59.95**



**JP Enhanced Reliability,**  
**Reduced Power AR Spring Set**  
**P44-12590 \$10.95**



**JP Reduced Power**  
**AR Spring Set**  
**P44-12618 \$10.95**

**Not Pictured, but also available:**

JP Enhanced .223 Gas Rings  
JP Enhanced .308 Gas Rings

**P44-11917 \$9.95**  
**P44-11718 9.95**

# Specialized Dynamics Emergency AR(epair) Kit

The Specialized Dynamics AR-15 Emergency Repair Kit includes: three gas rings, extractor spring, firing pin retaining pin, buffer retaining pin/spring, hammer/trigger pin, take down detent and spring.

**P44-19460 \$19.95**



*Crucial Parts for Your AR-15*

# Badger Ordnance Tac Latch



The Badger Ordnance Tac Latch makes it much easier for you to operate the latch on your AR-15/AR-10 charging handle. It works especially well for "flat-top" rifles equipped with low-mounted optics.

**P44-10379 \$18.95**

# Elzetta

## Tactical Flashlight Mounts



ZFH1500 Flashlight Mount for AR15s



ZSM Tactical Shotgun Flashlight Mount



ZRX Tactical Flashlight Mount

Every Elzetta ZFH1500 Flashlight Mount for AR15 rifles and ZSM Tactical Shotgun Flashlight Mount comes with sizing adapters, giving the mount the ability to accommodate flashlights from 0.7 to 1.05 inches (18 to 27 mm) in diameter. This includes flashlights from popular manufacturers such as InForce®, Streamlight®, Pelican®, Laser Devices®, SureFire® and of course, the Elzetta® ZFL-M60. (Sizing Adapters are not required when using an Elzetta ZFL-M60 or other 1-inch lights.) The Elzetta ZSM is made from the same advanced glass-filled polymer that has proven itself in the popular Elzetta ZFH1500.

The NEW Elzetta ZRX Tactical Flashlight Mount is made for flashlights with standard one-inch bodies and will accommodate a range from 0.94 to 1.04 inches (23.8 to 26.4 mm). This includes many popular tactical flashlights including the Elzetta ZFL-M60. The Elzetta ZRX clamping rings are made from Mil-Spec Type III Hard Anodized aluminum, the body is a glass-reinforced polymer and the hardware is steel. The ZRX weighs 1.1oz (32g).

ZFH1500 AR15 Flashlight Mount	<b>P44-12020</b>	<b>\$29.95</b>
ZSM Tactical Shotgun Mount	<b>P44-18050</b>	<b>39.95</b>
ZRX Tactical Flashlight Mount	<b>P44-15487</b>	<b>35.00</b>

## Viking Tactics V-TAC MK1 Sling



Viking Tactics' V-TAC MK1 Sling is quick, instantly adjustable to improve your shooting position, allows shooting from weak-side shoulder, secures the carbine during handgun transitions, and allows hands-free movement in difficult surroundings.

CAR-15	<b>P44-11961</b>	<b>\$34.95</b>
FN-FAL/HK-91	<b>P44-11962</b>	<b>40.00</b>

**WARNING:** The products offered for sale in this catalog can expose you to chemicals, including Lead, which are known to the State of California to cause cancer, birth defects or other reproductive harm. For more information, go to [www.P65Warnings.ca.gov](http://www.P65Warnings.ca.gov).

## KNS Precision, Inc. AR Accessories



Gen 2 Mod 2 Non-Rotating Trigger/Hammer Pins .154 Diameter.

**P44-33391 \$33.00**



Gen ST Non-Rotating Trigger/Hammer Pins .154 Diameter.

**P44-33392 \$38.00**



KNS Precision, Inc. AR-15 Bolt Catch Retainer Pin.

**P44-33390 \$9.00**



Perma-Pin Firing Pin Retainer for M-16 and AR-15 replaces the standard cotter pin found in the bolt carrier to retain the firing pin (as in original Stoner rifles). Made of tool steel. No modification to gun required.

**P44-19927 \$9.00**

## Schuster Mfg. Inc. Adjustable M1/M1A Gas Plugs

All Schuster Mfg. Inc. adjustable gas plugs are made in the U.S.A. from hardened tool steel, Parkerized and feature a lifetime factory warranty. By adjusting the volume of gas, you change the speed of the op rod and the barrel harmonics. If you're working up your own handloads, a quarter of a turn WILL affect your group size. Includes instructions and the adjustment tool (Allen wrench).



M1A (Pictured)	<b>P44-15405</b>	<b>\$59.00</b>
SOCOM M1A	<b>P44-15409</b>	<b>59.00</b>
M1 Garand	<b>P44-15408</b>	<b>40.00</b>



## Gunslinger Spring Kits

From Lee Fisher, one of the premier "cowboy gunsmiths."

Colt & clones	<b>P44-20510</b>	<b>\$26.95</b>
Ruger Blackhawk/Vaquero	<b>P44-20511</b>	<b>24.95</b>
Rossi/Navy Arms 92 lever guns	<b>P44-20513</b>	<b>24.95</b>
Stoeger IGA shotgun	<b>P44-20514</b>	<b>14.95</b>

# GUNSITE DEFENSIVE PISTOL CLASS LIFESAVING INSTRUCTION FOR PROFESSIONALS AND AMATEURS



Gunsite is a fighting school, so those skills learned on the square range are applied in training that includes clearing a structure.

By Doug Larson

Most informed shooters have heard of Gunsite Academy, located north of Prescott, Arizona. It is the oldest and arguably the best and most prestigious gunfighting school in the world, and it is certainly the oldest privately owned and operated school. It has trained everyone from women who have never handled a gun before to law enforcement, military and personnel from government agencies that try to keep their existence quiet.

Gunsite is not a school of competitive shooting. It is devoted to teaching law-abiding citizens in good standing how to defend themselves with a firearm; and the Gunsite curriculum, or doctrine, changes over time as new skills and tactics are learned from actual deadly force encounters.

Gunsite is about 3,200 acres in size and was started in 1976 as the American Pistol Institute by Lt. Col. Jeff Cooper, retired USMC. He developed what is referred to as the “modern technique of the pistol” and is typically what you see depicted in the movies and on TV when the good guys handle a gun – although Hollywood usually does a very poor job of portraying proper gun handling.

A student who has never handled a gun – and some even bring a gun in its box and have never shot it – will, after the five-day Gunsite 250 Defensive Pistol Class, be able to shoot and handle a handgun better than most police officers and military personnel. This is not an exaggeration.

I recently attended the Gunsite 250 Defensive Pistol Class. This is the class that is required before most other Gunsite classes can be taken, and teaches students the basics of defensive pistol use. It was not the first time for me, but it was for most of the other 22 students. They came from a variety of backgrounds including law

enforcement – both active and retired – and various vocations and professions. There were three law enforcement officers who were excellent shooters when they arrived, while one student, Brock Auten, was in his thirties and had been shooting nearly all of his life. He is a Doctor of Chiropractic, so is highly educated, but is still a regular guy.

I carried a Colt ([colt.com](http://colt.com)) Competition Series Government Model 1911 as did Brock. Both guns had the Series 70 trigger that some believe is better than the Series 80 system with its firing-pin safety. We both used holsters, magazine carriers and belts by Blade-Tech ([blade-tech.com](http://blade-tech.com)). Brock shot Doubletap ([doubletapammo.com](http://doubletapammo.com)) ammunition while I used Black Hills ([black-hills.com](http://black-hills.com)) ammunition. Both Colts were unmodified straight from the factory, except that I replaced the standard sights with excellent Truglo Tritium Fiber Optic TFX ([truglo.com](http://truglo.com)) sights that glow brightly in daylight or the dark. Everything worked very well. *[Editor's Note: Don't feel it's a requirement to bring a 1911 to Gunsite. Revolvers, striker-fired and SA/DA autos are all welcome.]*

There were three instructors, Mario Marchman, Steve Hendricks and Jerry McCown, and all have been instructors for many years. They all have law-enforcement backgrounds, know what they are doing and how to teach it. The class was divided so that only half was on the firing line at a time, so the student-to-instructor ratio was three to one, meaning all students got personalized attention. Perhaps I'm a slow learner, but even after numerous Gunsite classes and courses from other world-class gun fighting schools and instructors, I learned new things.

The curriculum included the four safety rules – they always come first and are strictly enforced. Gun handling, shooting positions, marksmanship, emergency



The blue Colt Competition Series Government Model in 9mm that was used by the author during the Gunsite 250 Defensive Pistol Course as it came from the factory.



The author replaced the Novak sights on the Colt 1911 with Truglo TFX sights that glow brightly in daylight or dim light and aid aging eyes with sight acquisition.



Brock Auten shot a stainless steel Colt Competition Series Government Model chambered in .45 ACP during the Gunsite 250 Defensive Pistol Course.

and tactical reloads, indoor and outdoor gunfighting tactics, interlimb interactions, drawing, holstering, malfunction clearing, controlled pairs, hammers, failure responses, non-standard responses, turns, movement, night shooting and the use of tactical lights are all covered. And if you don't know what some of those things are, you're not very well prepared for a deadly force encounter and need competent training. There isn't enough room here to explain these skills, and besides, you can't learn them from reading or watching a video. Training under the eye of a good instructor is needed to gain competence and learn how to perform these skills under stress without having to think about them.

Along about Wednesday, halfway through the class, many if not most of the students experience a phenomenon that has been called "the Gunsite Epiphany." They suddenly realize that most things they thought they knew about shooting and gunfighting were wrong and that they were now learning the right way to do things that could save their life or the lives of those they care about. They also realized that knowledge and skill can replace fear, and that they were developing the tools they need to deal with life-threatening confrontations that could happen anytime at any place. Even more importantly, they learned that the gun is a last resort, and that it is far better to avoid a fight if possible.

"I thought I was a decent shooter before the class," said Brock. "But sometime Wednesday, I realized not only that I was not very good before the class, I did not have a complete understanding of how fast a situation

can go bad and how fast I might have to react. I thought I had been pretty aware of what was going on around me, but I was not prepared to take action for self defense as quickly as might be necessary." Auten intends to take more Gunsite classes, and in fact, some students had actually signed up for more classes before the 250 class was over.

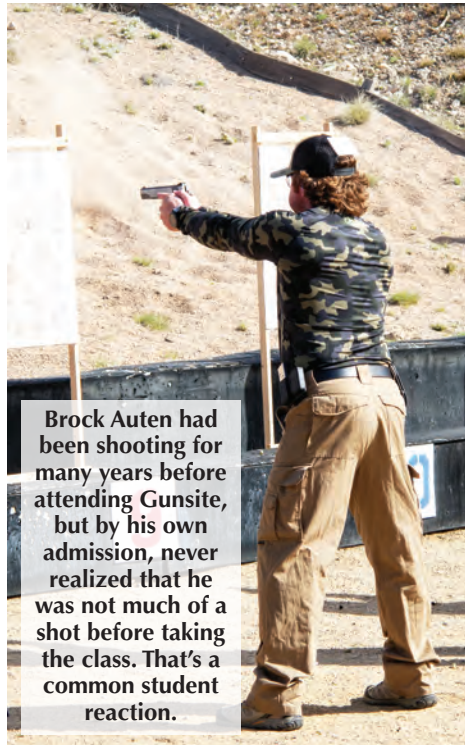

Brock Auten had been shooting for many years before attending Gunsite, but by his own admission, never realized that he was not much of a shot before taking the class. That's a common student reaction.

By the end of the class, both men and women students – even those who started out with poor or even no gun handling skills – were able to draw from a holster and fire two rounds hitting the center of the target at seven yards in 1.5 seconds. Remarkable, and that's just one of the benefits that comes from attending the class. Another is that if you enjoy shooting as a pastime, you will enjoy it even more from that point forward, if only because you become a better shooter.

Sure, Gunsite is expensive and most classes last five days. But good training is not cheap and students learn far more than they can in a one, two or even three-day class. People from all over the world come to Gunsite for training in handguns, rifles, carbines, shotguns and even edged weapons.

And some come back every year, or more often. They realize that it's impossible to put a price on their lives of the lives of people they love, so they make the time and financial commitment.

Gunsite Academy, Inc.  
2900 W. Gunsite Rd.  
Paulden, AZ 86334  
928-636-4565  
[gunsite.com](http://gunsite.com)



# Real Avid Gun Tools & Cleaning Gear

**NEW!**



Smart Mats™ are cleaning mats on steroids. The no-slip backed Spadded mat features an oil-resistant surface. It allows you to properly clean your gun without ruining the kitchen table and is large enough to handle field-stripped guns. The ingenious magnetic parts tray ensures your pins, screws and springs are never lost again. This is real world gun cleaning taken to the next level.

- AR-15 Smart Mat **P44-29041** **\$19.99**
- 1911 Smart Mat **P44-29040** **14.99**
- Handgun Smart Mat **P44-29042** **14.99**



The Master Bench Block™ is most comprehensive AR15 bench block ever! It allows you to tap 13 critical pins from 5 different components. The block is wrapped in an over-molding that grips to your bench to prevent slippage.

**P44-29033** **\$29.99**



This advanced kit includes every standard and roll pin punch needed to build or work on an AR15.

**P44-29032** **\$39.99**



The Lug-Lok™ Upper Vise block utilizes the strength of barrel lugs to safely secure AR15 upper receivers while you work, rendering clamp-style blocks obsolete.

**P44-29035** **\$79.99**

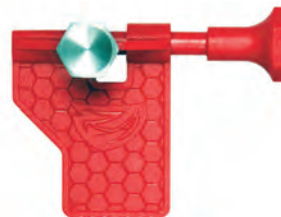

Installing a pivot pin is a small step that can quickly become a giant pain in the neck. Meet the AR15 Pivot Pin Tool – the one tool guaranteed to take the nail biting, pin-launching task of installing a pivot pin and turn it into something you might actually look forward to. Align the guide, insert the spring and detent pin, slide the pivot pin into place. Click. Snap. Done.

**P44-29034** **\$9.99**



Carbon Boss™ – AR15. This is the most comprehensive carbon removal multi-tool ever built. Extremely versatile, it has 12 precision surfaces to clean the most critical parts of your bolt, bolt carrier, cam pin, and firing pin. It's the enemy of your AR15's worst enemy.

**P44-29039** **\$29.99**

The unique Accu-Grip™ Picks and Brushes get the job done, feel good in your hand, and won't scratch your firearm.

Eight profiles dig gunk out of the places that even the sun don't shine. They're tough on the crud but tender on the metal. A better designed, better built detailing kit that just might make your dentist jealous.



**P44-29036** **\$9.99**

The AR15 Brush Combo™ contains the critical components you need to keep your AR15 chamber and bore carbon free. It contains a star chamber brush and star chamber mop for cleaning inside the hard to reach star chamber. Star chamber pads help collect left-over carbon while applying the perfect amount of oil or solvent. The .223/5.56mm bore brush scrubs baked on carbon from lands and grooves.

**P44-29037** **\$9.99**

There's no easy way to scrape carbon out of the star chamber of an AR15 unless you're a surgeon. That's why you use a star chamber brush to loosen the carbon then remove it with these star chamber cleaning pads. Done deal. Now get back to shooting. 20 wool chamber pads per package.



**P44-29038** **\$12.99**



# Swab-its A Swab for Every Job!

No s#!+, there I was...in my office, cleaning my revolver when the boss walks in with that "whisky-tango-foxtrot" look on his face. "Hi," I said (*thinking fast*), "I'm trying out these Bore-tips before I write the **Blue Press** copy for them. They work GREAT!" The **Bore-tips Swabs**



REALLY DO work. What you can't see under the foam is a plastic jag sized for a tight bore fit which provides for the uniform application of solvents and oils. They work with all standard 8-32 thread cleaning rods, and are tough and reusable.

.22/5.56mm (6 ea.)	<b>P44-15310</b>	<b>\$4.98</b>
.243/6mm (6 ea.)	<b>P44-15311</b>	<b>4.98</b>
.307/.62mm (6 ea.)	<b>P44-15312</b>	<b>4.98</b>
.357/9mm (6 ea.)	<b>P44-15313</b>	<b>4.98</b>
.40/10mm (5 ea.)	<b>P44-15314</b>	<b>4.98</b>
.45 Caliber (5 ea.)	<b>P44-15315</b>	<b>4.98</b>
12 Gauge (3 ea.)	<b>P44-15325</b>	<b>8.98</b>
<b>Multi Pack:</b> (6) .22/5.56, (6) .307/.62, (6) .357/9mm, (5) .40/10mm, (5) .45	<b>P44-43312</b>	<b>26.99</b>



**Gun-tips® Extended Reach Firearm Cleaning Swabs** by Swab-its® revolutionize the way you clean your gun. The foam tips are lint free, reusable and ideal for cleaning trigger assemblies, slide rails, springs, extractors and anywhere else space is tight. 24 per package.

**P44-12583 \$9.99**

**Bore-Whips™** .17 and .22 caliber (*pictured*) by Swab-its® are ideal for air rifles, rim-fires or any other .17 or .22 caliber firearm that's difficult to clean from the breach. The foam tips are reusable and the handle functions as an empty chamber indicator.



.17 Cal. **P44-12689 \$9.99**  
.22 Cal. (*Pictured*) **P44-12690 9.99**

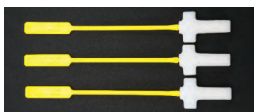

**Star Chamber Cleaning Foam Swabs™** are for AR-15, M4 and similar MSRs. 3-pack

**P44-10056 \$13.99**

The **Swab-its® Handgun Cleaning Kit** for 9mm/.357 caliber handguns contains four Bore-Sticks™, a three-in-one tool that replaces the cleaning rod, jag, and patch; a nine-piece Multi-Surface Gun-Tips® package for internal and external cleaning requirements; and a 0.4 ounce bottle of **BREAKTHROUGH®** Battle Born HP Pro lubricant and protectant. As with all Swab-its products, the Bore-Sticks and Gun-Tips are made of reusable, lint-free foam that is washable with degreasing soap and water or mineral spirits.

**P44-11907 \$19.95**



The **Swab-its® Modern Sporting Rifle Cleaning Kit** contains 6 .223/5.56 Bore-tips® for bore maintenance; a nine-piece Multi-Surface Gun-Tips® package for internal and external cleaning requirements; three Star Chamber Cleaning Foam Swabs™; and a 0.4 ounce bottle of **BREAKTHROUGH®** Battle Born HP Pro lubricant and protectant. As with all Swab-its products, the Bore-Sticks, Gun-Tips and Star Chamber Swabs are made of reusable, lint-free foam that is washable with degreasing soap and water or mineral spirits.

**P44-11908 \$24.95**

The **HYSKORE Degreezer** consists of a 12" x 6" x 4-1/2" polypropylene tray with an angled drainage surface and a well with a perforated basket for holding and draining small parts. The set also includes a standard double-end nylon gun-cleaning brush. Small parts and even complete trigger groups and bolt assemblies can be placed in the basket and the well filled with solvent to cover the parts and left to soak for extended periods. Then the basket can be withdrawn, draining all the parts. The set includes a cover with an integral holder for the brush. This means the solvent that has been contaminated by the cleaning process can be left in the well of the Degreezer (rather than returned to the bottle) with the cover in place so that it's ready to be used for the next cleaning event. The tray, cover, and basket are made from polypropylene plastic. This has been proven to be impervious to all popular commercial cleaning solutions. It will also resist kerosene, acetone, and gasoline.



**P44-10209 \$15.95**



On gun dealers shelves since 1976, the **ADCO E-Z Brite Wonder Cloth** is still a must for keeping stainless steel and nickel-finished revolvers looking like new. Demand the original lead and carbon wipe!

**P44-18613 \$7.99**

**D•WIPE Towels** were specially designed for immediate clean up of most contaminants without water. The soft 5.5" x 8" towels are saturated with a unique cleansing formula and aloe vera, and will remove heavy metals from skin and other surfaces.

**P44-19916 \$4.95**



Original **D•LEAD Hand Soap** quickly cleans heavy metals as well as paint dust and firing range residue from the skin and fingernails. Removes lead, nickel, cadmium, arsenic, mercury, silver, zinc and most other heavy metals.

8 Oz. Bottle **P44-19915 \$2.95**



**Ram Rodz Barrel & Breech Cleaners**

.22 Caliber/5.56mm, 300 count	<b>P44-43289</b>	<b>\$12.95</b>
.38 Caliber/9mm, 200 count	<b>P44-43290</b>	<b>12.95</b>
.40 Caliber/10mm, 100 count	<b>P44-43291</b>	<b>12.95</b>
.45 Caliber, 75 count	<b>P44-43292</b>	<b>12.95</b>

The **RamRodz® Range Kit** comes with 400 Breech Cleaners, 100 .22-Caliber swabs, 60 .38-Caliber swabs, 50 .40-Caliber swabs, 40 .45-Caliber swabs and 30 .50-Caliber swabs.

**P44-43293 \$34.95**



**WARNING:** The products offered for sale in this catalog can expose you to chemicals, including Lead, which are known to the State of California to cause cancer, birth defects or other reproductive harm. For more information, go to [www.P65Warnings.ca.gov](http://www.P65Warnings.ca.gov).

**Blue Press 65**

# Slip 2000 Products

## 725 Gun Cleaner Degreaser

should truly be called Super Degreaser. This water-based cleaner will cut through the toughest cosmoline, carbon, grease and grime! Its super strength allows it to degum and degunk the dirtiest of gun parts when sprayed on or used in parts washers or solvent tanks! **NOTE:** To help prevent rusting, users must apply a gun lubricant immediately after cleaning to disperse any moisture in parts.



16 Oz. P44-19237 \$21.99

## Slip 2000 Carbon Killer

provides you with a safe, effective way to clean carbon, lead and plastic wad fouling. Unlike other gun cleaners, this product is non-flammable, non-hazardous and biodegradable. Designed for soaking metal parts with baked on carbon, Carbon Killer dissolves carbon and lead on contact. **NOTE:** Carbon Killer is for cleaning internal metal gun parts with baked on carbon by soaking them. It is an aggressive cleaner and should not be used to clean the outside of your gun. It can damage and even remove some finishes.



16 Oz. P44-19234 \$21.99



Slip 2000's Extreme Cleaning System contains 2 Oz. bottles of: Carbon Killer Bore Cleaner, 725 Gun Cleaner Degreaser, and EWL Extreme Weapons Lubricant.

P44-11652 \$25.99



Slip 2000's AR Cleaning System contains a 7 Oz. bottle of Carbon Killer Bore Cleaner, a 15cc syringe of Extreme Weapons Grease, and a 1 Oz. bottle of EWL Extreme Weapons Lubricant.

P44-11676 \$19.99

Slip 2000 Extreme Weapons Lubricant (EWL) was designed for use on chain guns and machine guns like the MP5 and the 249SAW. It contains a proprietary Anti-wear agent that reduces friction and wear by 90-95 percent. It is an excellent CLP and is able to clean, lubricate and protect.



4 Oz. P44-11644 \$18.99

Slip 2000 EWL30 has the same properties as EWL, except it is a lot thicker. It contains a proprietary thickening agent that makes this lubricant consistency like a 30-weight motor oil. It was designed for those who want or need a lubricant that will not migrate at all and don't want to use a thick grease.



4 Oz. P44-11645 \$18.99

Slip 2000 Copper Cutfur is specially formulated to remove copper, lead, powder residue and plastic wad fouling from bore surfaces with little scrubbing! **NOTE:** It is a water based, ammonia enhanced product and will remove all lubrication or oil protection, so always re-lube all parts cleaned.



4 Oz. P44-11646 \$11.99

## Slip 2000 Gun Wipe

Each Slip 2000 Gun Wipe packet contains one 5" x 8" wipe treated with Slip 2000 Synthetic Gun Lube. Perfect for wiping your guns down after a day on the range or while out on a hunt. Apply to all metal surfaces. Great for light carbon cleaning. Safe for all firearm stocks and grips.



20 Pack P44-11674 \$14.99

## MIL-COMM

### Extreme Performance Lubricants

TW25B is the choice of leading firearms manufacturers, armorers, pro shooters and gun enthusiasts, and is recognized as the world's best all-purpose weapons lubricant/protectant. It is now widely specified by the U.S. military for their most critical performance weapons systems. Environmentally safe, non-carcinogenic, non-ozone-depleting.

0.5 Oz. Syringe  
1.5 Ounces

Revolver BLAST with TW25B is an all-synthetic lubricant/protectant specifically designed for revolvers.

4.2 Oz. Aerosol



P44-15732 \$10.99

P44-15731 14.50

P44-66677 \$11.95

## Brian Enos' Far Superior Slide-Glide

is a dual grease blend, with proprietary extreme pressure compounds, which boost the ability of the oils in the grease to withstand extreme pressures. It gives the grease a very stringy, tenacious character that makes it stay where you put it. Slide-Glide Standard is for use in warm weather (F60°+), Lite is a thinner viscosity for lower temperatures (F30°+).

Slide-Glide Standard  
Slide-Glide Lite

P44-15571 \$7.95

P44-15572 7.95



Microlon UltraBlue protects, penetrates and lubricates all surfaces. UltraBlue is in use by the US Army Marksmanship Training Unit, the US Army Pistol and Rifle Teams and the US Marine Corps Pistol and Rifle Teams.

P44-75125 \$9.95



## Sweet's 7.62

Sweet's Australian 7.62 Solvent easily removes powder residue and stubborn copper fouling. It's harmless to steel, a non-acid formula with five percent ammonia. If you shoot a rifle, you ought to try cleaning it with Sweet's.

P44-13128 \$12.95

# J. Dewey Manufacturing Co.



## DEWEY Nylon Coated Cleaning Rods

All Caliber Pistol 6"	P44-15461	\$19.95
(.22-.26 Jag Adapter for All Caliber 6" rod <sup>^</sup> )	P44-19894	3.25
(.27 & up Adapter for All Caliber 6" rod <sup>^</sup> )	P44-19895	3.25
.22-.26 Caliber Pistol 12"	P44-12985	23.95
.17 Caliber Rifle 26"	P44-11472	22.95
.17 Caliber Rifle 36"	P44-11473	25.95
.22-.26 Caliber Rifle 36"	P44-13084	26.95
.22-.26 Caliber Rifle 44"	P44-15462	25.95
(.22-.26 Jag Adapter for Rifle rod <sup>^</sup> )	P44-14542	2.25
.27 Caliber and up Pistol 12"	P44-13021	23.95
.27 Caliber and up Rifle 36"	P44-12991	24.95
.27 Caliber and up Rifle 44"	P44-15463	25.95
.35 Caliber and up Rifle 36"	P44-17096	29.95
.35 Caliber and up Rifle 44"	P44-17097	29.95
(.27 & up Adapter for Rifle rod <sup>^</sup> )	P44-14541	2.25
Shotgun Rod (Uncoated Brass <sup>^</sup> )	P44-10473	24.95
2-pc Shotgun Rod	P44-15464	31.99

## Brass Jags<sup>^</sup> (Note: These jags ONLY fit Dewey Cleaning Rods!)

.22 Caliber Brass Jag	P44-10026	\$2.99
.24 Caliber Brass Jag	P44-10027	2.99
.27 Caliber Brass Jag	P44-10025	2.99
.30 Caliber (and up) Brass Jag	P44-10867	2.99
.38 - .41 Cal. Brass Jag	P44-10028	2.99
.44 - .45 Cal. Brass Jag	P44-10243	2.99

## Brass Patch Loop<sup>^</sup>

Accepts most pistol and rifle patches P44-10737 \$2.25

## .17 Caliber Bore Brushes

.17 Caliber Rifle/Nylon (ea.)	P44-11475	\$1.95
.17 Caliber Rifle/Bronze (ea.)	P44-11474	1.95

## Nylon Bore Brushes<sup>^</sup>

.22 Caliber Rifle (ea.)	P44-16144	\$1.95
.243 Caliber Rifle (ea.)	P44-16145	1.95
.270 Caliber Rifle (ea.)	P44-16146	1.95
.30 Caliber Rifle (ea.)	P44-16147	1.95
.22 Caliber Pistol (ea.)	P44-16302	1.95
.38 Caliber Pistol (ea.)	P44-16148	1.95
.40 Caliber Pistol (ea.)	P44-16149	1.95
.45 Caliber Pistol (ea.)	P44-16150	1.95

## Bronze Bore Brushes<sup>^</sup>

.22 Caliber Rifle	P44-16278	Each/\$1.50	5 pack/\$5.50
.25 Caliber Rifle	P44-16293		P44-22089
.243 Caliber Rifle	P44-16280		P44-22094
.270 Caliber Rifle	P44-16274		P44-22091
.30 Caliber-7.62mm Rifle	P44-16273		P44-22085
.35 Caliber Rifle	P44-16281		P44-22084
.44-.45 Caliber Rifle	P44-16279		P44-22092
.22 Caliber Pistol	P44-16282		P44-22090
.38 Caliber -9mm Pistol	P44-16275		P44-22093
.40-.41 Caliber -10mm Pistol	P44-16276		P44-22086
.44-.45 Caliber Pistol	P44-16277		P44-22087
			P44-22088

## Cotton Mops<sup>^</sup>

.22-.27 Caliber (ea.)	P44-17089	\$1.95
.30-.38 Caliber (ea.)	P44-17090	1.95
.400-.450 Caliber (ea.)	P44-17091	1.95
16, 12 & 10 Ga. Shotgun (ea.)	P44-17094	1.95

## M-16/AR-15 Breech Rod Guide/Chamber Brush

Breech Rod Guide	P44-10149	\$20.00
AR-15 Chamber Cleaning Brush	P44-11299	3.50

## Deluxe M-16/AR-15 Lug Recess Cleaning Kit<sup>^</sup>

Lug Recess Cleaning Kit	P44-18533	\$27.95
-------------------------	-----------	---------

*Includes: Chamber Cleaning Rod, Lug Recess Cleaning Head, Delrin Guide Sleeve, 50-pak Cotton Cleaning Rolls, Chamber Brush, Chamber Mop, Double-Ended Nylon Cleaning Brush.*

## Bolt Action Rifle Cleaning Rod Guides<sup>^</sup>

All models fit .695-.700 bolt diameter rifles.

.17-.222, .225, .22/250, .220 Swift	P44-14196	\$18.95
.243 Caliber - 7mm	P44-14197	18.95
.30 Caliber	P44-14198	18.95
.338 Caliber	P44-14199	18.95

## Muzzle Guards

AR-15/M-16	P44-16875	\$10.95
M1-A/M-14	P44-16876	10.95
M1 Garand	P44-16878	10.95
Ruger 10-22 Standard Bbl.	P44-16877	10.95
Ruger 10-22 Bull Barrel	P44-16879	10.95
Brass Muzzle Guard, .30 Cal. <sup>^</sup>	P44-17245	10.95

## Nylon Gun Parts Cleaning Brush

Parts cleaning brush	P44-16389	\$2.25
----------------------	-----------	--------

## Cleaning Patches

Packages of 1000

.17 cal.	P44-11807	\$12.95
.22-.24	P44-11808	14.95

Packages of 500

.24-.27	P44-11809	\$11.95
.30-.35	P44-11810	13.95

Packages of 250

.38-.45	P44-11811	\$11.95
12-16 ga.	P44-11812	13.95

## AR-Link Cleaning Pin<sup>^</sup>



Dewey's AR-Link Cleaning Pin utilizes the rear take-down pin in your AR-15 style rifle to hold the upper and lower receivers open for cleaning. It fits AR-15s and AR-10s with take-down pins up to .316" in diameter. P44-18599 \$14.95



The Original M1 Buddy<sup>®</sup> Service Rifle Cleaning Port fits all models of M1 Garand and M1A rifles. The Original M1 Buddy is covered by a lifetime warranty and will be replaced free of charge if it fails under normal use. P44-13447 \$12.95



The Original Carbine Buddy Cleaning Port enables you to clean your M1 Carbine chamber without worrying about pinching your fingers. The Original Carbine Buddy is covered by a lifetime warranty and will be replaced free of charge if it fails under normal use. The Original Carbine Buddy P44-13452 \$9.99



Lymans Pick & Brush Set<sup>^</sup> is an indispensable item for your cleaning supplies and range bag. P44-40160 \$3.99

**WARNING:** The products offered for sale in this catalog can expose you to chemicals, including Lead, which are known to the State of California to cause cancer, birth defects or other reproductive harm. For more information, go to [www.P65Warnings.ca.gov](http://www.P65Warnings.ca.gov).

**Blue Press 67**

# Grace USA Gun Care Tool Set



This custom designed 12" x 9" x 1-1/2" case is made from durable soft Nukaf and contains a 17-piece set of Grace USA Gun Care Screwdrivers (8 ea.), Solid Brass Pin Punches (8 ea.) and a specially fabricated 8 Oz. Brass Hammer. The screwdrivers are hand-assembled and custom hollow ground to fit scope screws, plug screws, guard screws, etc. The handles are turned from quality Maine hardwood and protected with a smooth finish. Made in USA.

Grace USA Gun Care Tool Set<sup>^</sup>

**P44-10680 \$99.95**



Grace USA Gunsmith Hammer and Punch Sets<sup>^</sup>

8 oz. Brass Hammer	<b>P44-14969</b>	<b>\$15.95</b>
16 oz. Brass Hammer	<b>P44-15069</b>	<b>20.95</b>
Brass Punches (8-Pc.)	<b>P44-14968</b>	<b>31.95</b>
Steel Punches (7-Pc.)	<b>P44-15070</b>	<b>31.95</b>
8 oz. Brass Hammer & 8-pc. Brass Punch Set	<b>P44-21655</b>	<b>44.95</b>



## Secure Firearms Products Recoil Spring Tester

Secure Firearms Products' **Universal Spring Tester** will help you determine if the recoil spring in your pistol needs replacing, and you'll save time and money by testing and organizing loose recoil springs in your shooting bag.

**P44-15305 \$39.95**



## Tru-Weight Trigger Scale

The **Tru-Weight Trigger Tension Scale** has a range from eight ounces to eight pounds. A unique weight indicator remains at the exact point of trigger release, making it easier to read your trigger pull pressure.

**P44-14838 \$26.95**



## 10-8 Performance Armorer Tool

The 10-8 Performance Armorer Tool is a simple, non-marring tool useful for applications where prying or poking with metal tools can easily damage your work. The rigid chisel-pointed end and semi-flexible flat blade end each have unique uses.

**P44-15434 \$7.95**



## Bondhus Hex Key Sets



Ball-end set	<b>P44-13286</b>	<b>\$12.95</b>
Gorilla Grip Sm.	<b>P44-16822</b>	<b>5.45</b>
Gorilla Grip Lg.	<b>P44-16823</b>	<b>6.35</b>
Gorilla Grip Set	<b>P44-22142</b>	<b>10.75</b>

## Barrel-Lite<sup>®</sup>

**P44-10529 \$4.95**



# Specialized Dynamics Armorer's Upper Receiver Block



The **Specialized Dynamics AR15/AR10 Armorer's Upper Receiver Block** is made from billet aluminum and holds your upper receiver securely in order to make it easier to install barrels, free-float tubes, muzzle devices, etc. One block fits AR15s and ArmaLite and DPMS platform AR10s.

P44-43234 \$59.99

## M-14 Bolt Roller Greaser

So THAT's how you grease that little S.O.B. (*Slick-Operating Bolt, that is.*)

M-14/M1A Bolt Roller Greaser  
P44-18531 \$8.99



## Dillon Bushing Wrench ^



P44-11049 \$2.50

# STUL

## GLOCK Slide Removal Tool

Engages the slide lock and provides a mechanical advantage making slide removal easier and faster. For those with large fingers, small fingers, tired fingers, anyone looking for a way to simplify the removal of your GLOCK® slide.

P44-19527 \$11.95



## Arredondo Multi-Function Squib Rod



Magazine Base Pad Tool/  
Scope Battery Cap Remover

Scope Windage  
Adjustment Tool

This is a MUST-HAVE range-bag accessory. It's a squib rod (for removing stuck bullets), magazine base removal tool, and scope windage adjustment and battery cap removal tool.

P44-15250 \$12.95

## Lyman X-Block Gunsmith Bench Block



Having the right tool for the job makes any gunsmithing project so much easier! Without the right tool, you may damage fine finishes or break parts. The **Lyman X-Block** is the right tool for anyone driving pins out of firearms. It has all the features to get the job done smoothly and professionally. The X-Block has both a "V" slot and a rounded slot running across the face of the block to support a variety of barrels and slides. The block is made of a tough, non-marring polymer, and edged with a softer non-slip outer overmold. The block has multiple holes to take on most any project, as well as a molded-in magnet on the back side of the block to catch pins and other small parts as they drop out. Its large 5" diameter provides a stable base with plenty of support.

P44-11390 \$15.95

## NEBO®

The **NEBO® INSPECTOR^** is an innovative, powerful pocket light that outputs 180 lumens, with three light modes (High, 180 lumens for 2 hours; Low, 54 lumens for 6 hours; and Strobe, 180 lumens for 50 minutes) and a 3x adjustable zoom that provide the perfect amount of light for any situation. The INSPECTOR is also waterproof (IP67) and features a removable steel clip and Soft-Touch Technology, which provides momentary operation when the light is off with a slight touch of the button. Uses 2 AAA batteries.

P44-10206 \$19.99



*Note, while there are two lights pictured in this photo, only one is included for \$19.99.*



The **NEBO® INSPECTOR RC^** is a powerful 360 lumen rechargeable, waterproof (IP67) penlight. The INSPECTOR RC features FLEX-POWER and is equipped with a removable steel clip, 4x zoom and 3 light modes (high, low, strobe) and Soft-Touch Technology, which provides momentary operation when the light is off, with the slight touch of the button.

- 3 LIGHT MODES (Rechargeable Battery)
  - High (360 lumens) – 1 hour/125 meters
  - Low (120 lumens) – 3 hours/70 meters
  - Strobe (360 lumens) – 25 minutes/125 meters
- 3 LIGHT MODES (AAA Batteries)
  - High (100 lumens) – 1 hour/90 meters
  - Low (30 lumens) – 4 hours/50 meters
  - Strobe (100 lumens) – 25 min./90 meters

P44-13792 \$29.99

**WARNING:** The products offered for sale in this catalog can expose you to chemicals, including Lead, which are known to the State of California to cause cancer, birth defects or other reproductive harm. For more information, go to [www.P65Warnings.ca.gov](http://www.P65Warnings.ca.gov).

**Blue Press 69**

# The Colt 1908 Vest Pocket Model,

By Gus Cotey

John Moses Browning was the most prolific firearms designer of all time. His design genius led to the development of an almost unfathomable assortment of firearms of varied action types for an uncommonly wide variety of purposes; everything from tiny pocket pistols, to heavy caliber machineguns, to 37mm autocannons.

One of Browning's smaller designs was the semiautomatic Colt 1908 Vest Pocket Model in caliber .25 ACP, which was also referred to by Colt within the factory as their Model N. This gun was essentially an American made version of the Belgian FN Model 1905, first sold in 1906 and also a Browning design. The .25 ACP cartridge (*aka*, 6.35mm Browning and 6.35x16mmSR) is also a John M. Browning design initially

developed for use in the Belgian FN M1905 pistol.

This tiny centerfire round was intended to deliver similar performance as .22 Long Rifle ammo of the day in short barrels of equal length, but with the enhanced ignition reliability of central priming. The .25 ACP features a straight-sided, semi-rimmed case with a pronounced extractor groove, which permits the extractor hook to grab onto a greater surface area than possible with a .22 rimfire case, which further enhances functional reliability by means of more positive extraction.

The standard load for the .25 ACP is a 0.251 diameter, 50-grain FMJ RN, with currently advertised muzzle velocities from a 2-inch barrel of 750 to 771 fps, depending on the manufacturer. Older ammo catalogs from various makers stated the MV as 810 fps. Expanding bullet ammo is also currently available with advertised MVs of 900 FPS.

The Colt 1908 Vest Pocket pistol has a straight simple blowback semiautomatic operating system, meaning that the weapon fires from an unlocked breech and relies solely on slide mass and recoil spring tension to prevent significant slide movement upon firing until breech pressure has safely diminished. The 13-ounce pistol feeds from a 6-shot, single-column detachable box magazine retained in place by a heel-type magazine release. It has a 2.125-inch, 6-groove left-hand twist barrel with a twist rate of 1 turn in 16 inches. Unlike the also Browning-designed Colt M1903, caliber .32 Auto and M1908, caliber .380 Auto pistols designated by Colt as "Hammerless" models, but with internal hammers hidden by a space within the rear of the slide, the Colt M1908 Vest Pocket .25 ACP pistol is striker-fired and thus truly hammerless.

To fire the Colt 1908 Vest Pocket Model, the shooter inserts a loaded mag into the weapon's butt until the heel-type magazine release snaps in place to retain it. The slide is then retracted back as far as possible, which compresses both recoil spring (Colt's term, "Retractor Spring") and the firing pin spring (Colt's term, "Main Spring"). The slide is then released which

pushes the top round in the mag forward, up the barrel's feed ramp and finally into the chamber. Fully retracting the slide also pulls back the gun's striker-type firing pin until its integral cocking stud is captured by the sear and held in place.

Grasping the pistol in the firing hand disengages the grip safety, which permits the trigger to be pressed. Pressing the trigger pushes the connector on an upward angle, which in turn exerts pressure on the front of the sear, thereby causing the sear's rear portion – upon which the cocking stud of the gun's striker-type firing



**Author's blued, Colt Model 1908 Vest Pocket pistol, caliber .25 ACP with molded hard rubber-stocks and color case hardened trigger and grip safety. Note Colt's signature symbol, the "Rampant Colt" on the stock panel. This gun was built in 1920.**

# Caliber .25 ACP

pin is pressed against via spring tension – to pivot downward. This frees the firing pin to dart forward to set off the primer of the chambered round and ignite its powder charge. In order for the firing pin to maintain proper orientation, its integral cocking stud is contained within a guide slot milled into the 6 O'clock region of the firing pin channel.

As the slide is pushed backward via propellant gas pressure, the spent cartridge case is pulled from the chamber by the extractor and then flung free from the ejection port by the tip of the firing pin, which doubles as an ejector. The slide continues to move back a bit more allowing the firing pin to be retained in place by the sear grabbing onto its cocking stud. The slide now moves forward by energy supplied by the compressed recoil spring, picks up a fresh round, and returns to battery. When the trigger is released, the connector engages with the sear and another shot can be fired when the trigger is pressed again. Spring tension for the sear, connector, grip safety, trigger, and magazine catch is supplied by one fork-shaped, two-tined leaf spring residing in the rear of the frame.

The Colt 1908 Vest Pocket pistol has a manual safety on its left side at the rear of the frame. In the upward position, the weapon cannot be fired and the slide is locked in place, and when pushed downward, the gun is ready to go. There is also a small notch in the slide ahead of the safety cutout, which permits the rear corner of the manual safety to hold the slide open for inspection. In this position, the slide is not retracted far back enough to pick up a round from the magazine and too far back to facilitate disassembly. Note that when this pistol has fired its last shot, the slide does not lock open as with some other later designs.

Another important safety feature of the M1908 Vest Pocket pistol prevents the weapon from firing if the slide fails to go fully forward into battery. As the slide moves back, it simultaneously presses down on the connector, which prevents it from engaging the sear. Only when the slide is fully forward is the connector elevated high enough to engage the sear, thanks to a



The left side of the author's Colt M1908 .25 ACP pistol showing the manual safety. Note the "Rampant Colt" on the rear of the slide as well as on the grip panel.

mill cut lining up directly above the connector.

Sometime in 1916, the Colt Vest Pocket .25 ACP pistol began to be equipped with a magazine safety designed by Colt engineer George H. Tansley. Mr. Tansley was granted a patent for the device on July 31, 1917 (U.S. Patent No. 1,234,961); however, this patent date would not show up on Colt Vest Pocket pistols until the early 1920s. My own personal blued M1908 Vest Pocket .25, which was built in 1920, has the device installed, but the patent dates on the left side of the slide only go up to 1910.

The M1908 Vest Pocket pistol's Tansley-designed magazine safety device is activated when the magazine is out of the mag well by means of a cylindrical projection sticking out of the rear flange of the recoil spring guide. This projection enters a hole in the frame which applies force delivered by the recoil spring to a U-shaped component with two arms residing in mill cuts on

each side of the frame's mag well. When the device is activated by removal of the mag, the right arm presses on the connector, lowering it slightly and preventing it from engaging the sear. Inserting the magazine forces the device forward, which elevates the connector allowing it to engage the sear when the trigger is pressed.

I'm not a fan of magazine safeties, but I do admire the elegant simplicity of Mr. Tansley's device. Tansley received several other firearm-related patents, and even

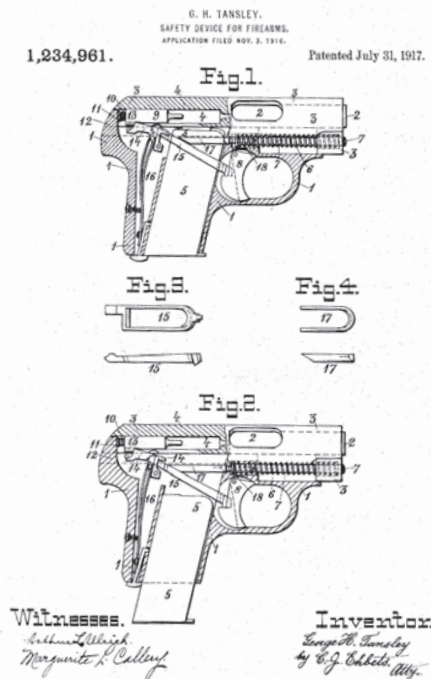

The patent drawing for the George H. Tansley-designed magazine safety device.



Author's Colt M1908 Vest Pocket .25 ACP pistol field stripped. From top to bottom: Slide, barrel, firing pin, firing pin spring with firing pin spring guide, recoil spring with recoil spring guide, and the frame. To the right is the magazine. Note the small, cylinder-shaped projection sticking out of the rear flange of the recoil spring guide for engaging the Tansley magazine safety device when the mag is removed.

one for a milk-and-cream separator. He must have been a clever man of uncommon mechanical aptitude.

Fieldstripping the Colt 1908 Vest Pocket pistol is relatively simple. First clear the weapon by removing the magazine and racking the slide back to examine the chamber and/or eject a chambered round if present. Now, press the trigger to dry fire the piece to release the firing pin from the sear. In the case of a gun equipped with a Tansley magazine safety, an *empty* mag must be inserted before this can be done and then the mag is removed. With the gun in the left hand, push the slide back with the right hand until the front of it is even with the rear portion of the series of longitudinal grooves milled around the circumference of the barrel right behind the muzzle. Now, rotate the barrel clockwise until three machined lugs are visible through the ejection port. The slide can now be removed from the frame, the barrel rotated back and tilted downward for removal, and the recoil spring, recoil spring guide, firing pin, firing pin spring, and firing pin spring guide removed as well.

The 1908 Vest Pocket pistol was available with either a blued or bright nickel finish. The customer also had a choice of molded black hard rubber, pearl, ivory, and checkered walnut stocks. The stocks of the early models were rounded at the tops, while those of later models

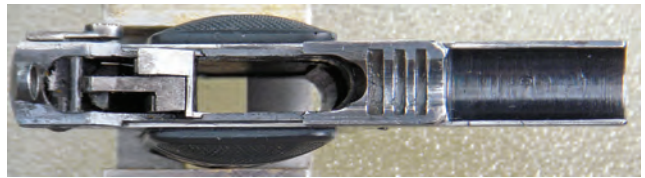

Top view of the frame of author's Colt M1908 Vest Pocket .25 ACP pistol. The three milled slots directly in front of and perpendicular to the magazine well are for the corresponding mounting lugs milled into the rear of the barrel. Directly behind the mag well is the connector and nestled next to it is the sear.

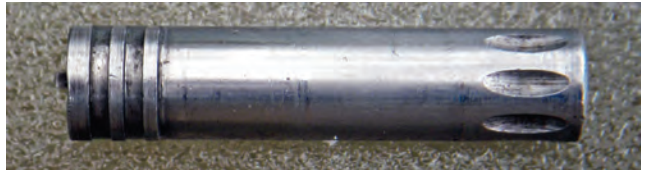

The barrel of author's Colt M1908 Vest Pocket .25 ACP pistol showing the mounting lugs at the chamber end (left side), which fit into corresponding slots in the frame and hold the slide and its components in place. Note also the longitudinal grooves milled around the circumference of the barrel right behind the muzzle which aid in rotating the barrel for disassembly.

were straight and parallel to the slide. The molded stocks have Colt's trademark "Rampant Colt" molded onto them while the others have medallions bearing the same symbol installed on them.

One often hears that it is impossible to hit anything with diminutive, small-caliber pistols such as the Colt Vest Pocket .25 ACP. With high quality guns like the M1908 Vest Pocket, this is patently false. These weapons are certainly not target pistols, but are certainly capable of placing most of their shots on a grapefruit-size target across the room in the hands of an adequately skilled marksman. I really enjoy shooting my personal Colt M1908 .25 ACP, which I inherited from my late father. The sights are really tiny and machined into the slide. They are hard to see under most conditions. What really helps, however, in delivering quick close range hits is the deep channel machined into the top of the slide, which acts like what was called a "guttersnipe" type of sighting system, to guide the shooter's eyes to the target.

My M1908 Vest Pocket pistol is reliable, provided that the ammo used is loaded hot enough to cycle the action. One lot of Focchi 50-grain FMJ ammo I recently used (Lot 4811009-0340 CIP 006) often failed to move the slide back far enough to pick up the next round from the mag. This lot averaged only 626 fps for 10 shots with a lowest recorded reading of only 580 fps. Remington UMC and Privi Partizan PPU (Serbian) 50-grain ammo tested on the same day cycled perfectly, with average respective velocities of 714 and 741 fps. Hornady Critical Defense 35-grain FTX ammo has likewise run perfectly through my gun, although I





Top view of the slide of author's Colt M1908 Vest Pocket .25 ACP pistol showing the tiny front and rear sights milled into it. Note also the pronounced machined channel, which acts as a "guttersnipe" sighting system for fast work at close range.



Looking at the underside of the slide from the author's pistol, one can see the guide slot milled through the 6 O'clock portion of the firing pin channel and through which the firing pin's cocking stud travels. The milled out area below the firing pin channel, commencing about one-half inch from the back of the slide is part of a safety feature which allows the connector to engage the sear only when the slide is fully forward and which prevents the weapon from firing out of battery.

have never had the opportunity to chronograph this load. As the gun is fired, cases are ejected briskly and their primers exhibit good, deep firing pin strikes.

One question often asked about the .25 ACP round is about its reliability as a defensive round against armed assailants. Well, as a general-purpose handgun round, the answer is certainly a resounding no. Even general-purpose defensive handgun calibers, including those beginning with a 4 after the decimal point cannot be consistently counted upon to quickly

incapacitate determined adversaries with single – or sometimes even several – torso hits. The little .25 ACP therefore, while certainly capable of inflicting mortal wounds with body shots, cannot be counted on to neutralize armed foes with anything but central nervous system hits delivered to the cranio-ocular cavity. At the very close-quarters, last-ditch desperate encounters for which it was intended, the little Colt Model 1908 Vest Pocket pistol is capable of, and has been successfully used to, deliver such hits. A few of these pistols were even issued during WWII to deep-cover operatives working for the Office of Strategic Services (OSS) the forerunner to the CIA, and clandestine elements of the US Military, such as the Army's G-2, CID, and CIC organizations.

Production of the Colt Vest Pocket .25 lasted from 1908 to 1948, with production ceasing from 1943 to 1945 due to the demands of WWII. The total number of these guns produced is often cited as 420,705 units, based on the highest serial number known to exist. The actual number is slightly under 410,000 based on a change in Colt's serialization shortly after WWII.

The Colt 1908 Vest Pocket Model, Caliber .25 ACP is not a toy. It is a purpose designed and built, very specialized highly concealable firearm intended for very close range defensive encounters of the most desperate and dire kind. Its inventor, John Moses Browning was many things. Among these, he was a mechanical genius, a successful designer of a prodigious array of firearms for a great multiplicity of uses, and an American patriot. One thing he was most definitely *not* was a toymaker.



# ECLIPSE HOLSTERS

Handmade holsters manufactured in Williamsburg, Virginia.



### OWB Holster<sup>^</sup>

1911	P44-66688	\$49.95
GLOCK 17	P44-66691	49.95
SIG 320	P44-66689	49.95
S&W M&P 9/40	P44-66690	49.95

### IWB Holster<sup>^</sup>

GLOCK 19	P44-66682	\$44.95
GLOCK 43, 43X	P44-66683	44.95
GLOCK 48	P44-66684	44.95
SIG 365	P44-66685	44.95
S&W M&P Shield	P44-66686	44.95
Shield .380 EZ	P44-66687	44.95



### Eclipse Lunar Dump Tray<sup>^</sup>

The Eclipse Lunar Dump Tray is the best place to empty your pockets at the end of the day, ensuring that you'll find everything you need for the next one!

P44-66695 \$34.95



### Eclipse Apollo 12 Wallet<sup>^</sup>

Hang on to your cash and your cards with this pocket safe! This Kydex wallet holds up to 12 cards. Forget wearing that bulky, uncomfortable wallet and carry a wallet that matches your style.



Black P44-66694 \$15.00  
Brown P44-66693 15.00

**WARNING:** The products offered for sale in this catalog can expose you to chemicals, including Lead, which are known to the State of California to cause cancer, birth defects or other reproductive harm. For more information, go to [www.P65Warnings.ca.gov](http://www.P65Warnings.ca.gov).

# C-More Systems



RTS2R



Railway

Built for speed, these High Performance red dot sights will take your shooting ability to the next level. By using a single red dot as an aiming point, target acquisition is as simple as point and shoot. The unique Heads-Up-Display (HUD) design provides an unlimited field of view, while eliminating obstruction and tunnel vision common to tube-style scopes.

#### C-More Systems RTS2R

6 MOA Black	P44-14518	\$419.00
8 MOA Black	P44-14563	419.00

#### C-More Systems Railway Sight

Polymer 8 MOA Black	P44-16413	\$279.00
Aluminum 8 MOA Black	P44-14611	329.00

#### C-More Systems Replacement Modules for Railway/Scout Sights

2 MOA Dot Module, Polymer	P44-14620	\$49.00
2 MOA Dot Module, Aluminum	P44-14643	49.00
4 MOA Dot Module, Polymer	P44-16415	49.00
4 MOA Dot Module, Aluminum	P44-14691	49.00
6 MOA Dot Module, Polymer	P44-16416	49.00
6 MOA Dot Module, Aluminum	P44-14696	49.00
8 MOA Dot Module, Polymer	P44-14717	49.00
8 MOA Dot Module, Aluminum	P44-14720	49.00
Railway/Scout/Tactical Battery	P44-17034	5.00
CR2032 Lithium STS/RTS Battery	P44-14721	5.00

# Bushnell TRS-25<sup>^</sup> Ultra Compact Red Dot Sight



Bushnell's Trophy TRS-25 Ultra Compact Red Dot Sight is designed for use on shotguns, handguns and rifles. It is constructed and assembled by highly skilled craftsmen to Bushnell's high quality standards. The precision and craftsmanship with which this scope was built ensures its performance under demanding conditions. This scope will provide the shooting accuracy and repeatability which have made Bushnell legendary. Features unlimited eye relief and a three-minute-of-angle dot.

TRS-25 (Includes riser, not pictured.)

P44-31318

\$119.95

## Scout Scope Mounts



Sorry, the optic pictured here is NOT included with the Scout Scope Mount.

Scout Scope Mounts provide an extremely stable optics base for your AK, Saiga or SKS rifle and will not shift, vibrate loose or change point of impact as the rifle heats up. Rock solid and easy to install, the two-piece design enables the removal and replacement of your optics without losing zero.

Scout Scope Mounts easily allow for complete DISASSEMBLY of your rifle for cleaning and maintenance while retaining zero. These rifles are designed so that carbon build-up can easily be cleaned from the gas tube and piston. This is routine maintenance, necessary in order to maintain a properly functioning rifle. Other mounts for AK-and SKS-style rifles make this difficult, time consuming and then require that optics be re-zeroed.

Scout Scope Mount for AK Rifle	P44-25374	\$79.99
Scout Scope Mount for SKS Rifle	P44-25373	78.99

# Competitive Edge Dynamics



## CED M2 Chronograph

P44-17926 \$199.00

The **M2 Chronograph** comes with sensors, screens and one two-foot mounting bracket. A nylon carrying case and tripod are available options. The **CED7000 Shot Timer** is a breakthrough in technology. No other timer to date offers this combination of advanced features, compact size and light weight. This is the "next generation" Shot Timer here today! Comes with a rechargeable battery with low-battery LCD indicator and a universal charger.



## CED7000 Timer

P44-19208 \$119.95

### M2 Chronograph Accessories

Infrared Chronograph Upgrade Kit	P44-12116	\$89.00
Rechargeable Battery Pack for Above	P44-12117	48.00
Nylon Carrying Case	P44-18145	35.95
Tripod	P44-18126	42.95
2-Ft. Skyscreen Mounting Bracket	P44-18120	14.95
Replacement Skyscreens	P44-18124	21.95
Replacement M2 Sensor	P44-18877	36.95

## PROTEKTOR MODEL

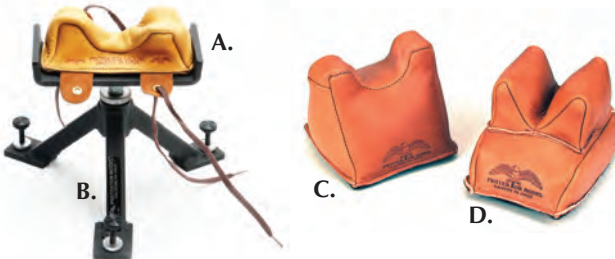

All Protektor Model leather bags are made with the best top grain cowhide available. The welded steel rest is strong enough to stand on and won't break if dropped (*Owl Ear Front Bag sold separately*). \*Sand not included.

A. Front Bag	P44-10880	\$24.00
B. Rifle Rest	P44-10883	63.00
C. Std. Front Bag	P44-10881	31.00
D. Rear Bag	P44-10882	34.00

## Evolution Gun Works Picatinny Rail Scope Mounts



### Available in Standard Elevation or Plus-20 Minutes of Angle

Remington Model 700 Short Action	P44-19975	\$39.99
Rem. Model 700 Short Action + 20 MOA	P44-19976	39.99
Remington Model 700 Long Action	P44-19977	39.99
Rem. Model 700 Long Action + 20 MOA	P44-19978	39.99
Ruger 10/22 + 20 MOA	P44-19987	39.99
Savage Short Action RB	P44-19979	39.99
Savage Short Action RB + 20 MOA	P44-19980	39.99
Savage Long Action RB	P44-19981	39.99
Savage Long Action RB + 20 MOA	P44-19982	39.99
Winchester Model 70 STD	P44-19983	39.99
Winchester Model 70 STD + 20 MOA	P44-19984	39.99
Winchester Model 70 Short Action	P44-19985	39.99
Win. Model 70 Short Action + 20 MOA	P44-19986	39.99



## MilDot Master

Become a master at using a Mil Dot reticle with this ballistic slide rule! Comes with a 24-page instruction manual.  
P44-14762 \$29.95

**WARNING:** The products offered for sale in this catalog can expose you to chemicals, including Lead, which are known to the State of California to cause cancer, birth defects or other reproductive harm. For more information, go to [www.P65Warnings.ca.gov](http://www.P65Warnings.ca.gov).

**Blue Press 75**

# Stribog SP9A1: An Ergonomic Win for CQB



Compact and lightweight, Stribog is an excellent defensive weapon for smaller-statured users, also for people who may have to fight around vehicles or other confined spaces.

## By Oleg Volk

Named after the Slavic god of wind, Stribog is a conventional-looking 9mm blowback firearm feeding from transparent double-stack, double-feed magazines of 10-, 20- and 30-round capacity. Available in submachine gun, carbine and pistol configurations, Stribog comes from Slovak gun maker Grand Power, known for the advanced rotary breech pistols designed by Juroslav Kurachina. Unlike the revolutionary GP K100 and its derivatives, Stribog seems mechanically conventional. A closer look reveals several original solutions combined with better-than-usual ergonomics.

The overhanging bolt configuration, with most of its mass positioned above the barrel, resembles Walther MPK. That keeps the receiver length down to a minimum without resorting to bullpup configuration. Unlike the MPK, Stribog uses an extruded aluminum rather than stamped steel receiver. A much simpler form, it is also much stronger thanks to the internal reinforcing rails. This use of folded rather than flat parts is a prevailing theme with Stribog: the ambidextrous bolt stop/release levers are also made as a mostly closed form for greater rigidity without additional weight. The serialized upper attaches to glass-reinforced polymer lower with two captured pins. The overall weight of the pistol is just over 5 pounds.

Despite firing from a closed bolt, Stribog is more than a pound lighter than MPK, and as short, while

mounting a longer 8-inch barrel. Everything about SP9A1 design is optimized for production, maintenance and speed of use. The bolt is a simple squared off reciprocating mass with a similarly simple bolt face and firing pin channel underneath, very simple to manufacture. Fieldstripping is done by punching out one captive pin in the back of the receiver to hinge the upper receiver forward to expose the backplate for installing a stock or an arm brace. The backplate is pressure fitted in place, and slides down with a tap of a rubber mallet to expose the inside of the receiver. On disassembly, the bolt slides out as unit with the recoil spring and guide, a guide rod and a double rubber recoil buffer. Further disassembly is usually unnecessary.

All controls are either ambidextrous, like the magazine releases, rotary safety levers and bolt stops, or reversible, like the non-reciprocating charging handle. Left-side mag release is just right for retaining magazines, while the right-side assumes drop-free magazines...but its transparent polymer magazines usually don't drop free when empty. That may change next year, when metal-reinforced magazines come to the market. The two bolt stops are stamped as a unit and have generously sized finger shelves, making locking or releasing the bolt very easy. Articulated up and down, and properly fenced against accidental activation, the bolt release doesn't activate accidentally when the



Two Stribogs fitted with adjustable length dual struts and Tailhook braces.



**SP9A1 functions perfectly with sound suppressors, but does show evidence of increased outgassing around the ejection port. Muzzle signature is nearly non-existent.**

weapon is placed flat on a surface. As with AR15, locking in a fresh magazine places the left hand perfectly for closing the bolt to chamber the first round. Everything about Stribog feels robust and streamlined for rapid deployment. Charging the weapon from a closed bolt requires only a moderate effort thanks to relatively light recoil spring and properly dimensioned charging handle, a welcome difference from many small blow-back guns. Since the bolt locks open on an empty magazine, bringing it back into action takes but a left thumb twitch. Enlarged trigger guard works with bulky gloves. The flared pistol grip is well textured but not abrasive. Combined with a brace, it enables comfortable and accurate one-handed firing if necessary.

Stribog comes with non-adjustable folding post and ghost-ring sights, well designed, non-glare. The front sight is inside a protective ring. When folded flat, the sights present smallish post and notch sights useful for firing the gun in the pistol configuration. Upgraded metal or metal adjustable sights are available from Grand Power EU, but the full-length Picatinny rail on top of the gun makes it more likely that the users would apply the same money to mount an optic and keep irons as backup. The iron sights are quite low, so they can be used through skeletonized scope or red dot bases, so AR-height sights would be more comfortable. Since factory-regulated sights seldom line up with actu-

al point of impact, I was pleasantly surprised to be able to hit a silhouette past 100 yards with them.

Accuracy is one of Stribog's strong points: with iron sights or red dot, I got almost exactly 4MOA with all loads from 90-grain frangibles to 185-grain subsonics. A slightly magnified optic, like a 1.5x compact ACOG, is recommended to take full advantage of the available accuracy. With a 2x scope, 2MOA groups were routine, suggesting that the mechanical accuracy is better than my ability to align unmagnified sights consistently. Unlike most 9mm carbines, Stribog doesn't shoot light bullets more accurately than heavy. That's great news for suppressed use, and also for extended ranges – heavy subsonics might have a steeper trajectory, but they retain more energy past 25 yards and are much less susceptible to wind drift. Loads used for testing were Federal Syntech Action Pistol 150-grain polymer coated "flying lipstick," Fiocchi 115-grain FMJ, Georgia Arms 115-grain FMJ, wide hollowpoint SIG 124-grain, 100-grain SBR frangibles, 185-grain Seismic plated HP and a few rounds of every other 9mm ammunition I could find. All types of ammo fed equally reliably. At this time, I am well over 850 rounds with no cleaning, about half fired with a sound suppressor: no malfunctions. While the Stribog's trigger feels heavy at over 5 pounds, it doesn't seem to get in the way of delivering accurate fire. The trigger mechanism is partly inter-

changeable with AR15 parts, so it can be lightened if desired. The long magazine well holds the mag securely enough to rest the gun on the floorplate for prone without causing malfunctions. The medium-weight barrel retains accuracy even when warmed up, which it does very slowly. The well-ventilated forend has a bottom Picatinny rail for accessories, not to include a vertical foregrip on the pistol variant due to NFA restrictions. A white light can be mounted close enough to the muzzle to avoid occlusion of the light beam. The long top rail permits placement of night-vision devices in front of the optic if desired. In addition, two M-Lok slots are available on each side of the forend.

Reliability, in general a feature of Jaroslav Kurachina's designs, is predictably excellent. In over a thousand rounds of all kinds of ammo, half of it fired with a sound suppressor without cleaning or re-lubricating afterward, SP9A1 has had zero stoppages of any kind. Between superb ergonomics and perfect reliability, this gun really gives confidence to the user! Ballistic performance from the 8-inch barrel is close enough to maximized for 9x19mm, with very little muzzle flash even with the hypervelocity loads. With 115- to 124-grain bullets, Stribog adds at least 100 fps to muzzle velocity over a typical service pistol. The weapon is suppressor friendly, with the muzzle factory threaded 1/2x28. A little blowback can be felt with the can on, something that the A3 variant expected in the US by

late 2019 solves. If you do not run it sound-suppressed, I would recommend Kaw Valley Precision's linear compensator to divert the report more towards the target, away from the shooter. Especially when used with 185-grain Seismic HP ammunition, it cuts down the muzzle blast considerably for a more comfortable experience and reduced hearing damage in case of a precipitous firefist.

Retail price is very reasonable at \$699. Global Ordnance ships this pistol with three 30-round magazines. Lightweight-but-sturdy magazines are very easy to load by hand. At \$30 each, additional 30-rounders are a good deal. Various braces are well worth the little they add to the price. Having shot it both with fixed single tube and two collapsible struts, I am a fan of the more flexible collapsible variant. Both are compatible with various braces. Gear Head Works Tailhook ([gearheadworks.com](http://gearheadworks.com)) seems to be the most compact and robust option. The pistol ships with two backplates, one set up for a tube and one for a braceless, pistol-grip-only configuration.

Compact dimensions, good balance and excellent ergonomics make Stribog an easy gun to shoot unsupported: hits on a silhouette from standing are easy past 100 yards. It's been a strong favorite with my range visitors and models. Well calculated spring and bolt weight ratio, along with the double rubber recoil

*Continued on Page 82*



Magazine well is extensively flared for ease of reloading.

**WARNING:** The products offered for sale in this catalog can expose you to chemicals, including Lead, which are known to the State of California to cause cancer, birth defects or other reproductive harm. For more information, go to [www.P65Warnings.ca.gov](http://www.P65Warnings.ca.gov).

**Blue Press 79**

# 101 Classic Firearms

John Marshall's book *101 Classic Firearms: A Chronological Foray into the Golden Years of Firearms Development*, is a compilation of the author's popular articles appearing in *The Blue Press* since 2007. *101 Classic Firearms* is sure to be a prized addition to the library of any serious firearms enthusiast. Published by Dillon Precision, and printed and bound in the USA, *101 Classic Firearms* is a high-quality full color 11.5" x 9" hardcover with 224 pages packed full of insights and history on some of the world's most important firearms. *About the Author:* John Marshall is an accomplished photographer and freelance writer whose articles have appeared in *The Blue Press*, *Gun Digest*, *Guns & Ammo's Handguns*, and *American Gunsmith*. An expert on firearms, he is also a member of the Remington Society of America, the Smith & Wesson Collectors Association, the Smith & Wesson Historical Foundation and the American Gunsmithing Association. John is also an endowment member of the National Rifle Association.



P44-40133 \$29.95



## Lyman Reloading Manuals



**Lyman 50th Edition Reloading Handbook** – Featuring More Loads, the Newest Components, Most Manufacturers, and More Load Data than Ever!

P44-10330 \$24.95

**Lyman Long Range Precision Rifle Reloading Handbook** P44-10207 \$16.98

**Lyman's Pistol and Revolver Reloading Handbook (Third Edition)** – The World's Leading Handgun Reloading Manual. P44-18967 \$21.95



**Lyman's AR Reloading Handbook** – Featuring loads for your AR chambered in popular cartridges from the .204 Ruger to the .50 Beowulf. P44-10976 \$12.99

**Lyman Shotgun Reloading Handbook, 5th Edition** – The Number One Shotgun Loading Manual. P44-12846 \$25.95



## The Complete Reloading Manual for...



Pretty much anything you're likely to be loading! That's right, all the data published by the various bullet and powder manufacturers for YOUR favorite cartridge.

.32 H&R Magnum	P44-15361	\$9.95
.380 ACP	P44-15362	9.95
9mm	P44-15363	9.95
.38 ACP	P44-15365	9.95
.38 Special	P44-15364	9.95
.357 Magnum	P44-15366	9.95
10mm/.40 S&W	P44-15367	9.95
.44 Special	P44-15368	9.95
.44 Magnum	P44-15369	9.95
.45 ACP	P44-15370	9.95
.45 Colt	P44-15371	9.95
.223	P44-15349	9.95
.22-250	P44-15348	9.95
.243	P44-15350	9.95
.270	P44-15351	9.95
7mm-08	P44-15352	9.95
7mm Rem. Mag.	P44-15353	9.95
7.62 x 39	P44-15359	9.95
.30 M1	P44-15354	9.95
.30-30	P44-15355	9.95
.308	P44-15356	9.95
.30-06	P44-15357	9.95
.300 Win. Mag.	P44-15358	9.95
.45-70	P44-15360	9.95



### Gun-Guides

Complete guides for all models of Ruger .22 pistols, 10/22 rifles and Mini-14s; and dis-/reassembly guides for other popular firearms.

### The Complete Guide

Ruger .22 Pistols	P44-40035	\$11.99
Ruger 10/22 Rifle	P44-40036	11.99
Ruger Mini-14	P44-40037	11.99

### Dis-/Reassembly Only

1911 Pistols	P44-40045	\$6.99
AK-47	P44-40038	6.99
Browning Buckmark	P44-40039	6.99
Colt AR-15	P44-40040	6.99
GLOCK Pistols	P44-40041	6.99
M1 Carbine	P44-40042	6.99
M1 Garand	P44-40043	6.99
Mauser Rifles	P44-40044	6.99
Mosin-Nagant Rifles	P44-40046	6.99
Mossberg 500	P44-40047	6.99
Remington 870	P44-40048	6.99
Remington 1100	P44-40049	6.99
Ruger Mk III Pistols	P44-40050	6.99
Ruger S.A. Revolvers	P44-40051	6.99
SKS Rifles	P44-40052	6.99
S&W M&P/Shield	P44-43230	6.99
1903 Springfield	P44-40061	6.99
Springfield XD/XDM	P44-40053	6.99
Winchester 1300	P44-40054	6.99



# Dillon-Video Favorites <sup>^</sup>



"Firestorm in the Desert (Machine Gun Magic)" – Dillon's own video portraying the history and excitement of the machine gun hobby. 60+ min.

- |   |           |         |
|---|-----------|---------|
| "Machine Gun Magic" DVD format              | P44-18312 | \$14.95 |
| "The Memphis Belle"/"The Fight for the Sky" |           |         |
| Two-DVD Set                                 | P44-18320 | \$24.95 |
| "P51 Mustang"/"Corsair"                     |           |         |
| Two-DVD Set                                 | P44-18321 | \$24.95 |

**⚠️ WARNING:** The products offered for sale in this catalog can expose you to chemicals, including BPA's, which are known to the State of California to cause cancer, birth defects or other reproductive harm. For more information, go to [www.P65Warnings.ca.gov](http://www.P65Warnings.ca.gov).



## Traveler's Guide

...to the Firearm Laws of the Fifty States – The myriad of firearm laws facing the gun owner of the early 21st Century can be intimidating when traveling.

P44-30201 \$14.95

## Individual First Aid Kits From The Tactical Medic



Nobody likes to think about it, but should a serious hunting/shooting accident occur, chances are the drugstore "first aid kit" you have stashed under the seat of your truck won't do much good. That's why we're offering individual first aid kits from The Tactical Medic. The Econo-IFAK contains a 4" Emergency Bandage, a TK-4 Combat Tourniquet, 1 Package of Rolled Gauze, 1 Roll of Medic's Tape and 1 Pair of Nitrile Gloves. The Micro Kit #2 contains a 4" Pressure Bandage, 1 Package of Quick Clot Gauze, a TK-4 Combat Tourniquet, 1 Roll of Medic's Tape and 1 Pair of Nitrile Gloves.

- |                                 |           |         |
|---------------------------------|-----------|---------|
| Econo-IFAK (at right in photo)  | P44-43379 | \$15.00 |
| Micro Kit #2 (at left in photo) | P44-43378 | 30.00   |

**⚠️ WARNING:** The products offered for sale in this catalog can expose you to chemicals, including Lead, which are known to the State of California to cause cancer, birth defects or other reproductive harm. For more information, go to [www.P65Warnings.ca.gov](http://www.P65Warnings.ca.gov).

# Wise Company's "Grab & Go" Emergency Food Kits

Wise Company's **18 Wise Favorites 72-Hour Kit** includes six entrées and three breakfast meals, each individually packaged for a total of 18 servings (2 servings per pouch). Entrées include meat. Packages included have a shelf life of 7 years compared to those in our buckets with a shelf life of 25 years. Great for hunting, camping and hiking! Simple to prepare, just add boiling water directly into pouch.



Wise Company's **60 Serving Gourmet Freeze Dried Meat "Grab & Go" Food Kit** includes 60 servings of assorted gourmet-seasoned freeze dried meat and a 20-serving bonus of long-term emergency rice, for a total of 80 servings. **Product within this Bucket is:** Roasted Chicken (12 servings), Teriyaki Style Chicken (8 servings), Cheesy Beef (8 servings), Southwest Style Chicken (12 servings), Savory Roasted Ground Beef (12 servings), Stroganoff Style Beef (8 servings), and Long-Term Instant Rice (20 servings).



Wise Company's **120 Serving Freeze Dried Vegetable and Sauce "Grab & Go" Food Kit** includes 120 servings of vegetable and sauce assortment. **Product within this Bucket is:** Corn (24 servings), Peas (16 servings), Broccoli (24 servings), Green Beans (24 servings), Butter Sauce (8 servings), Cream Sauce (8 servings), Cheese Sauce (8 servings), and Mushroom Sauce (8 Servings).



Wise Company's **60 Serving Gourmet Entrée Only "Grab and Go" Food Kit** includes two servings per day (entrées only) for one adult for one month or four adults for one week. **Product within this Bucket is:** Savory Stroganoff (8 servings), Chili Macaroni (8 servings), Pasta Alfredo (8 servings), Creamy Pasta and Vegetable Rotini (8 servings), Cheesy Lasagna (4 servings), Teriyaki and Rice (8 servings), Creamy Ala King and Rice (8 servings), and Creamy Tomato Basil Soup (8 servings).



Wise Company's **120 Serving Breakfast Only "Grab & Go" Food Kit** includes 120 servings of breakfast assortment (no entrées). **Product within this Bucket is:** Apple Cinnamon Cereal (40 Servings), Crunchy Granola (40 Servings), and Brown Sugar and Maple Multi-Grain (40 Servings).



Wise Company's **120 Serving Freeze Dried Fruit and Snack "Grab & Go" Food Kit** includes 120 servings of fruit and snack assortment. **Product within this Bucket is:** Bananas (16 servings), Strawberries (16 servings), Peaches (16 servings), Apples (16 servings), Caramel Sauce (16 servings), Yogurt (16 servings), and Pudding (16 Servings).





**Clockwise from above: 1. The molded polymer lower is very ergonomic, providing easy access to controls and has good texture for retention without abrasion. 2. Extruded aluminum receiver is corrugated for strength. Flip-up rear sight is in the deployed position. 3. Super simple one-piece bolt overhangs the barrel for compactness. 4. Unlike single-feed GLOCK magazines, Stribog mags load easily without any mechanical assistance. Polymer-coated Federal Syntech 150-grain carbine ammunition proved to be an excellent match for this gun.**



buffer in the back of the upper receiver all add up to moderate felt recoil. Thus far, Polish Railway police and Cape Verde SWAT officially adopted it. An updated A3 version with a remarkably simple roller-delayed blowback action has already been developed in 9mm Luger and 10mm Auto was recently a strong contender in the US Army PDW competition. Compared to the MP5 design, SP9A3 accomplishes the same goal with a single pin moving inside a bolt raceway. It is expected to be available from Global Ordnance by the end of 2019. The main benefits will be reduced felt recoil and delayed unlocking in suppressed use to reduce already minimal gas blowback. As it is currently configured, Stribog would be my personal first choice for a defensive 9mm sort-of-pistol, complimenting a GP Q100 or K100 pistol in the same caliber. Its ergonomics and reliability are excellent out of the box, and it doesn't require frequent cleaning. The price is right, too. Its main competitors are SIG MPX, which delivers lower felt recoil and similar accuracy, but requires more maintenance, and CMMG Banshee, which also has less felt recoil but trades off some accuracy in the pistol configuration. Both alternatives cost significantly more than the Stribog.

Global Ordnance LLC  
 2150 Whitfield Avenue  
 Buildings A&B  
 Sarasota, FL 34243  
 941-549-8388  
[globalordnance.com](http://globalordnance.com)



# SUPERHEROES!

*The real ones are not in the movies.*

There's a little real life superhero in all of us. Whether we have officially pledged to protect and defend...or if we are primarily concerned about the welfare of our loved ones...or if we just want to be prepared for any emergency. But, in order to be the best superheroes we can be, it's critical that we choose the very best tools that we can use, when needed, with ultimate effectiveness and confidence. We have some super solutions.

Les Baer Custom is the unchallenged leader in the design and production of custom 1911 pistols. More than a quarter-century ago we introduced state-of-the-art manufacturing methods, real hand assembly, and the use of top of the line accessories and other enhancements to ensure that our custom 1911s deliver the very highest standards of quality and performance. With multiple barrel lengths, frame sizes, several popular finishes and a choice of five calibers, there are more than forty Les Baer Custom 1911 models from which to choose, so you are sure to find one for virtually any purpose or preference.

No matter what kind of superhero you are.

Some of our most popular models include:



**Baer 1911  
Premier II®**  
5" or 6"

.45 ACP, 9mm, 10mm,  
.38 Super, .40 S&W

The flagship of the Baer Custom  
line, now available in four  
calibers, two barrel lengths,  
and multiple variations.



**NEW! Baer 1911  
GUNSITE Pistol, 5"**

.45 ACP

In honor of America's  
premier shooting  
academy.



**NEW! Baer 1911  
KENAI Pistol, 5"**

10mm

The only 1911 pistol that  
honors the Great State  
of Alaska.



**Baer 1911  
BOSS .45, 5"**

.45 ACP

A high performance tribute to  
the 1970s muscle car that  
inspired it: The Boss 429  
Mustang.



**Baer 1911  
Black Bear, 4 1/4"**

9mm

Perfect compact carry size with shortened  
slide. 9mm chambering for increased capacity.

See our entire line of  
high performance custom pistols at...

**WWW.LESBAER.COM**

Office Hours: 8:00 AM – 5:00 PM Central Time

**LES BAER  
CUSTOM, INC.**  
Performance. It's Everything.

1804 Iowa Drive • LeClaire, Iowa 52753

Ph: 563-289-2126 • Fx: 563-289-2132

Email: info@lesbaer.com





**the BLUE PRESS**  
 Dillon Precision Products, Inc.  
 8009 E. Dillon's Way  
 Scottsdale, AZ 85260-1809

PRSR STD  
 U.S. Postage  
**PAID**  
 Dillon Precision

Scan QR Code to  
 Shop on Our Site.



## Variable-Speed Casefeeder



- Variable-Speed Motor
- Adjusts from 0-8 RPM
- 2X Faster Than Before
- Gen II Casefeed Bowl
- Adjustable Window Cuff
- Universal Power Supply
- Greater Cartridge Capability Range

## Eclipse Holsters



*See Page 73*

## Comp-Tac Speedloader Holders



*See Page 26*

## Real Avid Gun Tools and Cleaning Gear



*See Page 64*

## Dillon Precision Logo Cap

**P44-11319**  
**\$11.95**



## DILLON PHONE NUMBERS

**Orders/Expert Assistance: 800-223-4570**

For orders and technical assistance.

**Order Status/Basic Orders: 800-762-3845**

Order by stock numbers only  
 (no technical questions please);  
 or to quickly check the status of your order.

**Catalog Request: 800-762-3844**

To order *The Blue Press* catalog.

**Dillon Showroom Hours: M-F, 9a-6p; Sat., 8a-3p**