

the **Blue Dress**

October 2018  
\$2.95 U.S. / \$3.95 Canada



**Laws  
We Need,  
and  
Why  
YOUR Vote  
Matters!**

*Page 10*

# EDC

NOW STANDS FOR  
EVERYDAY CHOICES

The **Ruger® EC9s™** comes with no gimmicks, rebates or mail-in offers for gift cards... just the rugged, reliability of the striker-fired LC9s®, now with integral sights and a no-hassle price point that won't break the bank.

The **Ruger® Security-9®** is an affordable, rugged, mid-sized pistol that provides everyday security in the perfect caliber, size and price point.

**WHY CHOOSE BETWEEN THEM  
WHEN YOU CAN HAVE BOTH?**



## Dillon's RF 100 Automatic Primer Filler

*Eliminates the need  
for primer pick-up tubes!  
Fills the primer tube  
while you reload!  
Clear polycarbonate shield  
and protective housing*

Dillon's RF 100 Automatic Primer Filler<sup>^</sup> eliminates the task of filling primer pick up tubes. Now you simply pour your primers from their box into the top, press the blue button and watch it run!

In about two minutes the primers are inside the protective metal housing. That's about 30 rounds you can load while the RF 100 is doing your work for you!

The RF 100 is available for either large or small primers, and conversion kits are available at one low price of \$50.95 each.

Lg. Primer Filler	<b>O86-97077</b>	<b>\$344.95</b>
Sm. Primer Filler	<b>O86-97111</b>	<b>344.95</b>
Lg. (Euro. 220v)	<b>O86-97112</b>	<b>354.95</b>
Sm. (Euro. 220v)	<b>O86-97113</b>	<b>354.95</b>
Sm. Conversion	<b>O86-17903</b>	<b>50.95</b>
Lg. Conversion	<b>O86-17902</b>	<b>50.95</b>
Nylon Packcloth Dust Cover <sup>^</sup>	<b>O86-11143</b>	<b>14.95</b>



<sup>^</sup> **WARNING:** The products offered for sale in this catalog can expose you to chemicals, including Lead, which are known to the State of California to cause cancer, birth defects or other reproductive harm. For more information, go to [www.P65Warnings.ca.gov](http://www.P65Warnings.ca.gov).

## THE BEST AR RIFLES USE THE BEST PARTS

**100% AMERICAN MADE  
WITH A 100% CUSTOMER  
SATISFACTION POLICY**



**WILSON COMBAT**

LEARN MORE AT  
[WWW.WILSONCOMBAT.COM](http://WWW.WILSONCOMBAT.COM)

[RUGER.COM](http://RUGER.COM)



© 2018  
Sturm, Ruger & Co., Inc.  
011118

**RUGER**

# 4 What's Inside:



**Ruger American Rimfire .22 WMR**

Page 36

## Taylor's & Co. Half-Pint Sharps .44-40 Win.

Page 44



## The "Why" and "How" of Precision Reloading

Page 48



# Product Index

### Dillon Precision Products Reloading Machines:

BL 550	13
Square Deal "B"	8
RL 550C	14
XL 650	20
SUPER 1050	30
SL 900 Shotgun Loader	38
Big Fifty Reloader .50 BMG Loader	50
RF 100 Automatic Primer Filler	3
Vibratory Case Cleaners	18
Case/Media Separators	18
Dillon Progressive Reloading Dies	34-35
Redding Reloading Dies	52
Dillon Reloading Scales	86
Reloading Components	42-43
Books & Videos	82-83
Ear Protection	7, 12
Eye Protection	12
Dillon Ammo Boxes & Bins	64
Dillon Leather by Mitch Rosen	24-25
Concealed Carry Tote	26
"Plan B" Dayplanner Holster	51
Dillon Range Bag/Ammo Bag/Shooting Mat	32
Targets and Target Stands	54
Firearms Maintenance	66-67

**ATTENTION DILLON CUSTOMERS:** Because of changes to California's Proposition 65 that take effect on August 30, 2018, companies doing business in California are mandated to provide warnings on products that may expose Californians to any one or more of a list of approximately 900 chemicals, including Lead, which are "known to the State of California to cause cancer, birth defects or other reproductive harm." The new regulation states that a warning must be "provided in the catalog in a manner that clearly associates it with the item being purchased." Though we have no reason to believe our products could cause harm when used as intended, we now include the appropriate Proposition 65 warnings on some of our products to meet the California "safe harbor" requirements.

# We READ Our Mail!

I just read your article on Lena Miculek; it's one of the best articles in a long time. I watch her and her family shooting on their "Shoot Out Lane" show. I watch all the time, the whole family is great and fun to watch. Keep articles like this coming. Thanks!

Walter Metz - bjmetz@comcast.net

Thanks Walter! It really was a great article, other than my misspelling of Lena's last name on page 79 when I did the layout.

Regarding *The Blue Press*, September 2018: Even as a disabled senior, I've had the pleasure to squad with Lena, Jerry, and Kay Miculek three times at 3 Gun national meets (I was lucky to get in). All are very approachable, super skilled, and willing to share knowledge, but Lena really stands out as a tactician and businesswoman. She really is how you described her. Good article.

Leslie Watkins - fasterthan911@hotmail.com

P.S. - You spelled her name wrong on page 79.

Hi, Leslie! Yeah, nothing like making an error in 24-point display type to get everyone's attention. I've already apologized to Lena, by the way.

In the September *Blue Press*, Connie Bowlby's article about GSSF has an error in that it states GSSF moves you to master after four wins. It's actually three wins (as top amateur in any division), and then you're a master.

Jon Lewis - jlewis@lewis.org

After eight years and 80,000+ rounds, my 550 was getting a bit cranky. Called Tech Support and they were able to diagnose the problem over the phone. A couple of days later replacement parts arrived, no charge. I'd buy a rock from your company, as I know it would be backed by your warranty. What a way to support your products and what a legacy to Mike. Thanks for doing business in such an ethical manner!

Jim O'Reilly - Prescott Valley, AZ

Thanks, Jim! What caliber rock are you interested in buying? I have one with a polymer frame that I'd let go pretty cheap right now.



YOU PRACTICE AND RE-PRACTICE.  
OBSESS OVER DETAIL AFTER DETAIL.  
ALL IN SEARCH OF PERFECTION.  
NOTICE A PATTERN HERE?



We now offer a smartphone app for both Apple and Android. Search for "Dillon Precision" at the iPhone App Store or Google play.

# THE BLUE PRESS

Stephen M. Dillon - Publisher  
Mark G. Pixler - Editor  
mpixler@dillonprecision.com

Gary Kieft - Technical Editor

This Issue's Contributors:

John Bibby  
Peter Caroline  
Alan Korwin

John Marshall  
Duane Thomas  
Oleg Volk

Issue #316  
October  
2018

Copyright 2018 by  
Dillon Precision  
Products, Inc.

All the electrical and/or electronic components of Dillon equipment and all Dillon textiles are covered by a one-year warranty from date of purchase. Any modifications performed to Dillon machines, or the addition of any unapproved equipment, including automated or mechanical add-ons from other manufacturers, is expressly not recommended and will void the Dillon warranty.



IMR® 4166™ WITH ENDURON™ TECHNOLOGY. MAKE IT PART OF YOUR ROUTINE.

Extreme temperature stability meets copper fouling elimination for the consistency you demand. It's a new habit that will become as familiar as ringing steel.



Phone 913-362-9455 | www.imrpowder.com

# 6 Which Dillon is Right for YOU?



Page 8



Page 14



Page 20



Page 30

## SQUARE DEAL B

Our automatic-indexing progressive reloader designed to load moderate quantities of common handgun calibers from .32 S&W Long to .45 Colt. It comes to you from the factory set up to load one caliber.

## RL 550C

The most versatile reloader available, capable of loading over 160 calibers. An automatic casefeeder is available for handgun calibers. Manual indexing and an optional magnum powder bar allow you to load magnum rifle calibers.

## XL 650

Truly the state of the art, our XL 650 features automatic indexing, an optional automatic casefeeder and a separate station for an optional powder-level sensor. Available in all popular pistol and rifle calibers.

## SUPER 1050

Our highest production rate reloader includes a swager to remove the crimp from military primer pockets, and is capable of reloading all the common handgun calibers and several popular rifle calibers.

## Dillon Progressive Loading Machines: Facts & Figures

	SQUARE DEAL B	RL 550C	XL 650	SUPER 1050
<b>COST</b>				
Base price	\$426.95	\$479.95	\$589.95	\$1811.95
Caliber Conversion price range	\$91.95-101.95	\$47.95-57.95	\$79.95-89.95	\$127.95-280.95
<b>RATE</b>				
Cyclic rate (Rounds per hour)	300-500	400-600	500-800**	1000-1200
One hour production rate	350	500	800**	1000
Caliber change time	10 min	5 min	10 min	20 min
<b>FEATURES</b>				
Number of stations	4	4	5	8
Auto index	yes	no	yes	yes
Auto Casefeeder	no	optional	optional	standard
Uses standard (7/8" x 14) dies	no	yes	yes	yes
Powdercheck System	no	no	optional	optional
Primer Early Warning System	standard	standard	standard	standard
Failsafe Powder System	standard	standard	standard	standard
Separate Crimp Station	yes	yes	yes	yes
<b>SPECIFICATIONS</b>				
Primer magazine capacity	100	100	100	100
Casefeed capacity (.38/.223)	N/A	N/A	600/500	600/500
Powder measure capacity	3/4 lb	3/4 lb	3/4 lb	3/4 lb
Shipping weight	17 lbs.	25 lbs.	36 lbs.*	66 lbs.
Height required above bench***	34 in.	35 in.	44 in.	43 in.
Benchtop overhang required***	1-3/4 in.	3/4 in.	3/4 in.	None
<b>CALIBERS</b>				
Pistol	.32 S&W - .45 Colt	All common	All common	All common
Rifle	N/A	All common	All common	.223 - .30-06

\*XL 650 weighs 47 lbs. with optional Casefeeder. \*\*With optional Casefeeder. \*\*\*Without optional Strong Mount.

800-223-4570 or 480-948-8009 • FAX 480-998-2786 • 24-Hour On-Line Ordering @ [www.bluepress.com](http://www.bluepress.com)

# DILLON

## HP1 Electronic Hearing Protector

- Protection Rating NRR 21
- External battery compartment
- Auto shut off extends battery life
- Extra-deep, replaceable ear pads
- Separate volume controls for each ear
- TRUE stereophonic sound
- Collapsible for ease of storage
- One-year warranty on electronics



Dillon's HP1 Electronic Hearing Protector amplifies weak sounds while at the same time blocking out loud, harmful noise. During loud noises, the HP1 maintains a comfortable level of sound transmission – HP1 Hearing Protectors are designed to never completely shut off. The Dillon HP2 Folding Hearing Protector is comfortable to wear for extended periods and folds for easy storage when not in use.



## Dillon Hearing Protectors

HP1 (NRR 21) Electronic Hearing Protector, Blue <sup>^</sup>	O86-10157	\$135.00
HP1 Electronic Hearing Protector, Black <sup>^</sup>	O86-10156	135.00
HP2 (NRR 21) Non-Electronic Hearing Protector, Blue <sup>^</sup>	O86-10361	19.95
HP2 Hearing Protector, Black <sup>^</sup>	O86-10360	19.95
HP1/HP2 Replacement Ear Cushions <sup>^</sup>	O86-19022	10.00
Hearing Protector Belt Clip	O86-13020	3.29

<sup>^</sup> **WARNING:** The products offered for sale in this catalog can expose you to chemicals, including DEHP, which are known to the State of California to cause cancer, birth defects or other reproductive harm. For more information, go to [www.P65Warnings.ca.gov](http://www.P65Warnings.ca.gov).

# 8 SQUARE DEAL 'B' ^

## STANDARD FEATURES:

- Automatic Indexing
- Available in 18 Handgun Calibers
- Loading Rate: 300-500 Rds./Hr.
- Comes With One Caliber Conversion
- Automatic Powder Measure
- Automatic Primer System
- Comes Complete With Dies
- Factory Adjusted, Ready-to-Use
- Lifetime "No-B.S." Warranty
- **RISK FREE 30-Day Trial!**

All for ONLY...  
**\$426<sup>95\*</sup>**

## "SDB" Stock Numbers

.32 S&W Long/H&R Magnum*	O86-16815	\$456.95
.380 ACP	O86-20053	
.38 Special	O86-20102	
.357 Magnum	O86-20103	
.38 Super	O86-20099	
.38 Super Comp	O86-20115	
9mm	O86-20104	
.40 S&W	O86-20787	
10mm	O86-20643	
.41 Magnum	O86-20054	
.44 Special	O86-20105	
.44 Magnum	O86-20052	
.44-40 Winchester	O86-21036	
.45 ACP	O86-20101	
.45 Colt	O86-20051	
.45 GAP	O86-20098	
.45 S&W Schofield	O86-20418	

Total price as pictured here  
with optional accessories: **\$636.70**

SDB Strong Mount	O86-22223	\$66.95
Low Powder Sensor	O86-16306	\$42.95
Bullet Tray	O86-22214	\$44.95
Tool Holder w/Wrench Set	O86-19441	\$27.95
Ctg. Case Bin & Bracket	O86-11672	\$26.95



**SDB DVD**  
Instruction Manual ^  
O86-19482 \$19.95

## SQUARE DEAL 'B' ACCESSORIES

### A. SQUARE DEAL 'B' CONVERSION KITS ^

Change from one caliber to another in minutes. Conversion includes carbide size die (except .44-40), expander/ powder funnel, seat die, crimp die, shellplate and locator buttons.



.32 S&W Long/H&R Mag.	O86-16774	\$101.95
(.32 S&W Requires X-Small Powder Bar O86-20780 \$32.95)		
.380 ACP	O86-20246	91.95
.38 Special	O86-20240	91.95
.357 Magnum	O86-20240	91.95
.38 Super	O86-20229	91.95
.38 Super Comp	O86-20275	91.95
9mm	O86-20241	91.95
.40 S&W	O86-20469	91.95
10mm	O86-20469	91.95
.41 Magnum	O86-20247	91.95
.44 Special	O86-20242	91.95
.44 Magnum	O86-20242	91.95
.44-40 Winchester	O86-21035	91.95
.45 ACP/.45 GAP	O86-20123	91.95
.45 Colt	O86-20248	91.95
.45 S&W Schofield	O86-20417	91.95

### SQUARE DEAL 'B' DELUXE QUICK CHANGE ^

(Not Pictured) Includes toolhead, powder measure and SDB Toolhead Stand.

O86-62256, \$130.95

### 'SDB' POWDER MEASURE ^

O86-20001, \$84.95



### B. SQUARE DEAL 'B' TOOLHEAD ^

Extra toolheads keep all your adjustments the way you left them.

O86-20113, \$33.95

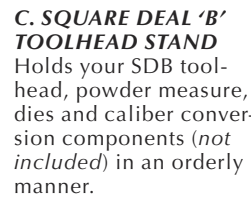

### C. SQUARE DEAL 'B' TOOLHEAD STAND

Holds your SDB toolhead, powder measure, dies and caliber conversion components (not included) in an orderly manner.

O86-62225, \$26.95



### D. SQUARE DEAL 'B' BENCH WRENCH

The Square Deal Bench Wrench has the correct sizes for Square Deal "B" die adjustments.

O86-19970, \$8.95 each.

Buy two or more, \$8.10 each.

### E. SQUARE DEAL "B" STRONG MOUNT & CARTRIDGE CASE BIN COMBO

Ergonomically designed to cut your workload through economy of motion! Mounts your Square Deal "B" along with a bin for your empty cartridge cases.

O86-62395, \$75.95



### F. SDB CARTRIDGE CASE BIN & BRACKET ONLY

For those who already have a Strong Mount, the blue bin and silver bracket in the above photo are available separately (hardware not included).

O86-11672, \$26.95

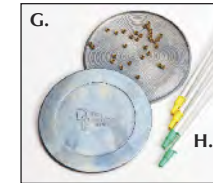

### G. PRIMER FLIP TRAY

O86-13606, \$22.95 each

### H. PRIMER PICKUP TUBES

1 Lg. tube	O86-22029	\$7.99
1 Sm. tube	O86-22028	7.99
2 Sm., 2 Lg.	O86-20056	25.95
4 Lg. tubes	O86-20050	25.95
4 Sm. tubes	O86-20049	25.95

### I. MACHINE COVER ^

This great looking nylon cover adds security to your loading bench. Your reloader will be protected against more than dust as these covers come with a D-ring that allows the heavy duty zipper to be locked.

Cover, O86-13795, \$23.95

(J.) Master lock, O86-13083, \$3.95



### K. MACHINE MAINTENANCE KIT ^

Everything you need to keep your Dillon loader cleaned and lubricated up to factory specifications. Available in combination with a spare parts kit for your machine.

Maint. Kit/SDB Spare Parts Kit O86-97015, \$36.95

### L. SDB SPARE PARTS KIT ^

- 1 SD Shellplate Bolt
- 1 SD Ejection Wire
- 4 SD Wave Bearings
- 1 Toolhead Friction Plate
- 2 Pistol Decapping Pins
- 1 Small Primer Seat Punch
- 1 SD Slide Return Spring
- 1 #10 Tinnerman Insert
- 1 Bellcrank Cube
- 4 Locator Pins (#1, #2, #3, #4)
- 1 Indexer Return Spring
- 1 Large Primer Seat Punch
- 1 Primer Seat Punch Spring
- 2 Pickup Tube, Small, Yellow Tips
- 2 Magazine Orifices, Large



- 2 Pickup Tube, Large, Green Tips
- 1 3/16" Index Ball
- 2 Magazine Orifices, Small
- 2 Retaining Clips
- 1 SD Index Lever Assembly
- 2 Dispensing Tips, Large
- 2 Dispensing Tips, Small

O86-20778, \$22.95

### DON'T FORGET ONE OF THESE!

Universal Mounting Hardware Kit

O86-14355 \$5.49

**WARNING:** The products offered for sale in this catalog can expose you to chemicals, including Lead, which are known to the State of California to cause cancer, birth defects or other reproductive harm. For more information, go to [www.P65Warnings.ca.gov](http://www.P65Warnings.ca.gov).

# 10 Laws We Need, and Why Your Vote Matters! 11

By Alan Korwin  
**National Carry Matters**

How long do you think we're going to have to wait for H.R. 38 to pass? H.R. what? You know – the National Reciprocity Act, where your right to carry a firearm doesn't end at your state line. It's the law designed to remove legal obstacles that deny your firearm-carry rights. Unlike marriage and driver licenses, your carry license, or even your Constitutional Carry rights, become null and void when you step over an invisible line into the state next to yours.

That good law was introduced on January 3, 2017 – after Mr. Trump was elected but before he even took office. Your vote helped put him in there. Not only did you help put him there by a good margin – 60 percent to 40 percent in the Electoral College (30 states to 20, which infuriates the people who hate the guy and love the socialist-leaning woman he locked out) – it gave him majorities in both houses of Congress. When they say your vote matters, well there it is on a platter.

But though “we” (i.e. gun owners) have both houses and the White House, somehow we still can't get National Carry passed. It went to the House of Representatives on January 12, to the Judiciary Committee, and it's still there. Your “staunch pro-gun-rights” elected officials have not moved it forward. The Senate is another roadblock. What they did do, very sneaky, is extract the part where a ton of money goes to federal agencies so more names can flow into the NICS Index, the list of who can't have a gun, and passed that, so-called Fix NICS. National Carry was left out. You voted for these people.

Funny thing is, democrats who want to take over Congress again, like they used to have under the previous guy, they've been instructed by their leadership to lay off the gun issue. It's too hot a potato. It could hurt them, infuriate the public (us) and make them lose. If that's true, why don't republicans push for more and better gun laws, encourage us, do the right thing, and while they retain power at least now, restore our rights nationwide? Why indeed.

This is where you come in. It turns out H.R. 38 is practically the least of it. We got that bill started, we all know why it's important and we want it, yet our people snookered us. They hung the bait – reciprocity – then canned that and funded the gun-ban list. If you don't know who represented you, now is as good a time as any to figure that out, and personally let them know you want the pro-rights part to move.

Establish a relationship with that office; you're going to need it. And they're going to need you, because the elections will change who's around, and if your rights are important (I know, you say they are, but will you prove it by acting?) you'll need to know who's running, and be registered to vote. Even kids are registering. They could swing things against you.

### It's Not Just About National Carry

We need important new laws that aren't even introduced yet. I've been writing a lot about infringement laws, a fresh concept. These have to start at your state level and several have started the ball rolling. The U.S. Constitution, as you know, says our right to arms “shall not be infringed.” But since the Constitution has a fatal flaw – no punishments for violating its terms – we need to introduce penalties. “Shall not be infringed” means infringement is illegal. **It is**

**banned.** Officials who infringe on you or your guns violate the Constitution under which they operate and they need to be held accountable. We intend to make it so.

Your state must join with others and define infringement in simple terms, so it is enforceable. This has been alluded to in *The Blue Press* and you'll be hearing more about it. “Banning arms or related accessories the public already legally owns is infringement.” That's straightforward, accurate and could not be clearer. The bill itself would be more detailed of course, and I'll have the technical language posted at [GunLaws.com](http://GunLaws.com) soon. The rubber meets the road with the next part of such a statute. “Taking or attempting to take an infringed item is aggravated infringement,

a felony.” Now the statute has teeth, officials are restricted and put on notice.

### Next Steps

The American Protection of Arms Act (the “aggravated infringement bill”) is just the beginning of a broad gun-rights offensive this nation needs to push back against the astounding level of anti-rights gun prejudice we're witnessing from politically active socialists and others.

Leftist gun bigots, a hopelessly biased “news” media, and now a totally misinformed public that has come to believe the many myths they've been bombarded with for years, are seeking office and promoting legislation that will send us to the dark ages. They would ignorantly arm the authorities even more heavily than they are, incrementally disarm the public, and pay inadequate attention to criminals and crazies who are the real problem.

We need to elect people who understand and will help enact defensive display laws so you're not charged if you need to show or reference your

firearm to deter crime. Your state needs frivolous-lawsuit protections so criminals and their kin can't bring you up on civil charges after you legitimately shoot people trying to harm you. We must repeal gun bans that discriminate against decent people who simply possess their constitutionally protected firearms when they travel in their neighborhoods taking care of business. The list of laws we need is long, and we'll examine and justify them one after another.

But remember this – if you don't get active politically, and help elect good people, our chances of passing good laws, and stopping horrible ones, will be a daydream our children and future generations will look back on and hold us accountable for in disgrace.

Alan Korwin's website features plain-English books on state and federal gun laws for the public, and more common sense like you just read. He invites you to write to him or see his work, at [GunLaws.com](http://GunLaws.com), where you can get books and DVDs that help keep you safe.

“Since the Constitution has a fatal flaw — no punishments for violating its terms — we need to introduce penalties.”

**PREMIUM quality 2XL 100% GENUINE NO FILLER MADE IN U.S.A.**

**Try One On For Size!**

**The perfect fit in sporting magazines for those who appreciate the finest.**

**Call or go online for FREE copies of RIFLE and HANDLOADER magazines and find your size.**

**Subscribe now for our BEST PRICES EVER!**

Mention Code DIL15

**Wolfe Publishing Company**  
2180 Gulfstream, Ste. A • Prescott, AZ 86301  
Toll Free: 1-800-899-7810 • Online: [www.riflemagazine.com](http://www.riflemagazine.com)

**RIFLE** - Sporting Firearms Journal  
50+ Years with the .223 Remington

**HANDLOADER** - AMMUNITION RELOADING JOURNAL  
Handloading the .26 Master  
New Life for the .300 Savage  
175 Loads for the Popular .40 S&W!

# ABSOLUTE. PREMIUM. PROTECTION.

## WILEY X PROTECTIVE EYEWEAR<sup>^</sup>



**Romer 3 \$95**  
3-Lens Pkg., Smoke Grey, Clear, Light Rust **O86-12104**



**WX Valor \$95**  
3-Lens Pkg., Smoke Grey, Clear, Light Rust **O86-12105**



**WX Saint \$95**  
3-Lens Pkg., Smoke Grey, Clear, Light Rust **O86-12102**

WILEY X PROTECTIVE EYEWEAR MEETS ANSI, EN166 AND MILITARY VO BALLISTIC STANDARDS

**Bomber Glasses \$9.99**

Bomber Glasses' lenses and frames are made from High-Index Polycarbonate that is durable, flexible and impact resistant. All colors provide UV protection.

Clear	O86-10513
Smoke	O86-10514
Light Blue	O86-10515
Yellow	O86-10516
Amber	O86-10517
Smoke Mirror	O86-10518

## Bifocal Shooting Glasses



- Clear, Bottom Bifocal**
- Clear Bifocal 1.5 **O86-11820 \$19.95**
  - Clear Bifocal 2.0 **O86-11821 19.95**
  - Clear Bifocal 2.5 **O86-11822 19.95**
- Smoke, Bottom Bifocal**
- Smoke Bifocal 1.5 **O86-11825 \$19.95**
  - Smoke Bifocal 2.0 **O86-11829 19.95**
  - Smoke Bifocal 2.5 **O86-11831 19.95**

**Ear Pro EP3 Sonic De-fenders<sup>®</sup>** by Sure-Fire<sup>®</sup> protect you against loud, harmful noises, yet allow normal conversations to be heard; and the soft, hypoallergenic polymer provides all-day comfort. **NRR 24**

Small	<b>O86-25340 \$12.95</b>
Medium (Fit Most People)	<b>O86-25341 12.95</b>
Large	<b>O86-25342 12.95</b>

**FLUGZ**

Advanced hearing protection that's easy to custom fit for all-day comfort. Comes with everything you need to fit to your ears. **NRR 21**

**O86-43384 \$19.95**

800-223-4570 or 480-948-8009 • FAX 480-998-2786 • 24-Hour On-Line Ordering @ [www.bluepress.com](http://www.bluepress.com)

# BL 550<sup>^</sup>



**Dillon's Basic Loader**

**\$287<sup>95</sup>**

**O86-15399**  
Reloading Dies and Caliber Conversions sold separately (see the back of the order blank in the center of *The Blue Press*).  
Pictured with optional accessories:  
Strong Mount **O86-22051 \$50.95**

## Spares, Accessories & Upgrades for AT 500s, BL 550s & RL 550s

### AUTO PRIME SYSTEM<sup>^</sup>

- Includes:**
- Primer Housing /Shield
  - Primer Slides, Large/Small
  - Pickup Tubes, Large/Small
  - Pickup Tube Tips, Large/Small
  - Magazine Tubes, Large/Small
  - Mag. Orifices, Large/Small
  - Operating Rod
  - Primer Track Bearing
  - Housing Screws
  - Ret. Spring Retaining Pin



**O86-16627, \$89.95**



### PRIMER SYSTEM EARLY WARNING<sup>^</sup>

Allows you to focus on loading instead of worrying about failing to seat a primer, and is an easy slip-on attachment to the auto prime system.

**O86-20302, \$26.95**

### AUTO POWDER SYSTEM<sup>^</sup>

Accurate to within 0.1 grain, our Automatic Powder Measure is world renowned for its charge-to-charge consistency.

**O86-20251, \$95.95**

### OPTIONAL MAGNUM RIFLE POWDER BAR

**O86-21353, \$32.95**



### AUTO EJECT SYSTEM<sup>^</sup>

Greatly increases your ammo production capabilities and adds a Cartridge Chute/Bracket and a Cartridge Bin to your reloader.

**O86-22120, \$33.95**

### BL 550 POWDER DIE<sup>^</sup>

Extra powder dies allow you to move your powder measure from toolhead to toolhead without changing the "belling" adjustment.

- Powder Die: O86-16629, \$19.95**
- Oversize Die: O86-16626, \$20.95**
- Plastic Funnel: O86-16617, \$6.49**



### POWDER MEASURE ADAPTER

If you load rifle cartridges with long-grain extruded powder, you can now use any manufacturer's powder measure with 7/8" x 14 threads on your RL 450, AT 500, BL 550 or RL 550. (Requires the use of an RL 450 powder die – see below.)

**O86-20029, \$23.95**  
**RL 450 Powder Die: O86-20308, \$22.95**

Dillon's RL 550 has long worn the title of "The World's Most Versatile Progressive Reloader," and stripping it down to its most basic form – Dillon's BL (Basic Loader) 550 – adds a whole new dimension of versatility for the shooter/hunter who needs to feed several rifles.

The BL 550 is essentially an RL 550 without the automatic priming and powder systems. Capable of loading over 160 calibers – just like the RL 550 – it uses any manufacturer's standard 7/8" x 14 reloading dies. It's priced comparably with other manufacturers' turret presses; yet unlike them, it's fully upgradeable to Dillon's Progressive RL 550 loader!

The interchangeable toolhead (Page 15) makes it quick, easy and inexpensive to change calibers. For example, if you load .30-06 for elk, .243 for deer and .22-250 for coyotes, you don't even have to change the shellplate. You simply pull two pins and swap the toolhead with your .30-06 dies to another toolhead with your .22-250 or .243 dies in less than 30 seconds! The additional toolheads are \$26.45 each, or \$24.45 each if you buy three or more – if you load for several rifles it's a no-brainer! Once you get your dies adjusted, you'll never have to re-set them.

A powder measure adapter (bottom right photo) is available if you want to use a manual measure that you already own. Or, if you want to weigh every powder charge you load, it's easy – you can use a powder trickler with the powder die/funnel assembly that comes with the BL 550.

**WARNING:** The products offered for sale in this catalog can expose you to chemicals, including Lead, which are known to the State of California to cause cancer, birth defects or other reproductive harm. For more information, go to [www.P65Warnings.ca.gov](http://www.P65Warnings.ca.gov).

# RL 550C<sup>^</sup>

## STANDARD FEATURES:

- Accommodates Over 160 Calibers
- Uses Standard 7/8" x 14 Dies
- Loading Rate: 400-600 Rds./Hr.
- Comes With One Caliber Conversion
- Interchangeable Toolhead Assembly
- Automatic Powder Measure
- Automatic Primer System
- Lifetime "No-B.S." Warranty
- **RISK FREE 30-Day Trial!**

All for ONLY...  
**\$479<sup>95\*</sup>**

**086-14261**

Reloading dies sold separately.  
\*Prices vary on exotic-caliber machines.



**RL 550 DVD**  
Instruction Manual<sup>^</sup>  
086-19483 \$19.95

Total Price as pictured here with optional accessories: **\$792.60**

.45 ACP Die Set	O86-14404	\$69.95
Strong Mount	O86-22051	\$50.95
Roller Handle	O86-17950	\$47.95
Low Powder Sensor	O86-16306	\$42.95
Bullet Tray	O86-22214	\$44.95
Toolholder w/Wrench Set	O86-11541	\$29.95
Cartridge Case Bin/Bracket <sup>^</sup>	O86-11185	\$25.95

## RL 550C ACCESSORIES



**A. RL 550 CALIBER CONVERSION KITS<sup>^</sup>**  
Contains: Shellplate, powder funnel and locator buttons. Available in all calibers; please specify caliber desired.

**O86-RL550 CONVERSION \$47.95**  
(Exotic calibers, \$57.95<sup>^</sup>)

### B. AUTO POWDER MEASURE SYSTEMS<sup>^</sup>

Additional powder measures stay on the toolhead. Never change powder measurements again!  
RL 550 Powder Measure  
**O86-20782, \$84.95 ea.**  
Magnum Rifle Powder Bar  
**O86-21353, \$32.95 each**  
X-Small Powder Bar  
**O86-20780, \$32.95 each**



### C. DELUXE QUICK CHANGE ASSEMBLY<sup>^</sup>

With a quick change assembly and a caliber conversion kit (SOLD SEPARATELY), you can convert in less than a minute. Complete with:

- Toolhead
- Powder Measure
- Powder Die
- Toolhead Stand

Price without Dies, **O86-22058, \$112.95**  
Loading dies sold separately on Pages 34, 35 & 52.

### D. POWDER DIES<sup>^</sup>

Extra powder dies allow you to move your powder measure from toolhead to toolhead without changing the "belling" adjustment.



**O86-20064, \$12.95 each**  
**Three or more, \$11.95 ea.**

**X-Large Powder Die, O86-21253, \$19.95 each**

### E. TOOLHEADS

Don't adjust dies when switching calibers. These precision tool holders hold your dies in perfect alignment, making caliber changes quick and easy.

**O86-13909, \$26.45 each**  
**Three or more, \$24.45 ea.**



**F. TOOLHEAD STANDS**  
The ultimate in convenience for keeping your reloading bench clean and uncluttered.  
**O86-22055, \$22.95 each**  
**Three or more, \$20.95 ea.**

**G. 1" BENCH WRENCH**  
**O86-10842, \$7.95 each**  
**Two or more, \$7.10 ea.**



### H. RL 550 CASEFEEDER UPGRADE<sup>^</sup>

Available for most pistol cartridges – will not work with rifle cartridges.  
Large Pistol O86-14450  
Small Pistol O86-14451  
**\$279.95 (110v US Model)**  
Large Pistol O86-14453  
Small Pistol O86-14454  
**\$289.95 (220v Euro Model)**



### CASEFEEDER CALIBER CONVERSIONS (Page 17)

**\$25.95 each**

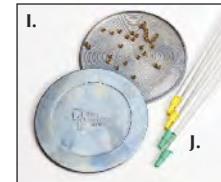

**I. PRIMER FLIP TRAY**  
**O86-13606, \$22.95 each**

**J. PRIMER PICKUP TUBES**

1 Lg. tube	O86-22029	\$7.99
1 Sm. tube	O86-22028	7.99
2 Sm., 2 Lg.	O86-20056	25.95
4 Lg. tubes	O86-20050	25.95
4 Sm. tubes	O86-20049	25.95

### K. 550 SPARE PARTS KIT<sup>^</sup>

- 1 Seating Punch, Small
- 1 #10 Tinnerman Insert
- 1 Primer Cup, Large
- 1 Primer Cup, Small
- 1 Bellcrank Cube
- 1 3/8" Index Ball
- 1 550 Brass Tip Set Screw
- 1 550 Ejector Wire
- 1 Cartridge Retaining Spring
- 1 550 Slide Return Spring
- 4 Locator Pins (#1, #2, #3, #4)
- 1 Seating Punch, Large
- 1 550 Index Ball Spring
- 2 Pickup Tube, Small, Yellow Tips
- 2 Magazine Orifices, Large
- 1 Toolhead Pin



**K.**  
2 Pickup Tube, Large, Green Tips  
2 Magazine Orifices, Small  
1 550 Primer Cup Spring  
2 Retaining Clips  
2 Dispensing Tip, Large  
2 Dispensing Tip, Small  
1 Failsafe Bushing Rev. B  
**O86-20048, \$19.95**

### L. MACHINE MAINTENANCE KIT<sup>^</sup>

Provides you with everything you need to keep your Dillon loader cleaned and lubricated up to factory specifications. Available in combination with a spare parts kit for your machine.



**Maint. Kit & Spare Parts Kit O86-97016, \$33.95**



**M. LOW POWDER SENSOR<sup>^</sup>**  
Provides an audible and visual reminder when it's time to refill your powder reservoir. When the powder level drops to about 1000 grains, a buzzer will sound and a bright red LED will light.

**O86-16306, \$42.95**

### N. EQUIPMENT DUST COVERS<sup>^</sup>

This packcloth nylon machine cover comes equipped with a D-ring, allowing the heavy duty zipper to be locked.

RL 550 Cover, **O86-13795, \$23.95**  
(O.) Master lock, **O86-13083, \$3.95**

Quick-Change Cover<sup>^</sup> (for use with powder measure)  
**O86-11143, \$14.95**



**P. UNIVERSAL MOUNTING HARDWARE KIT**  
Includes: 4-Grade 5 Hex Bolts, 4-Lock Nuts, 4 Flat Washers, 4-Fender Washers, 2-Wood Screws.  
**O86-14355, \$5.49**



# Dillon Reloading Accessories

**Dillon's Reloading Accessory Package Deals** include: either Dillon's D-Terminator Electronic Scale or Eliminator Balance Beam Scale, a Dial Caliper, a Primer Flip Tray, a Bench Wrench, an 8 oz. bottle of Case Lube, a pair of clear safety glasses, a machine cover and the latest edition of the Lyman *Reloading Handbook*.

SDB (Balance Beam Scale)	<b>O86-14482</b>	<b>\$192.95</b>
SDB (Electronic Scale)	<b>O86-14483</b>	<b>251.95</b>
RL 550 (Balance Beam Scale)	<b>O86-21143</b>	<b>191.95</b>
RL 550 (Electronic Scale)	<b>O86-22117</b>	<b>250.95</b>
XL 650 (Balance Beam Scale)	<b>O86-21430</b>	<b>207.95</b>
XL 650 (Electronic Scale)	<b>O86-22118</b>	<b>266.95</b>

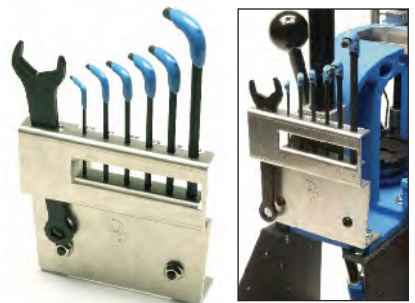

**Dillon's Strong Mounts** increase your machine's "foot-print" to over 10", spreading the load over the whole bench instead of stressing the leading edge. For XL 650 owners with limited overhead clearance, the XL 650-only mount raises the machine 6" above the bench top. All mounts come with all the fasteners necessary to mount your machine and are coated with a durable black wrinkle finish.

RL 550/XL 650	<b>O86-22051</b>	<b>\$50.95</b>
XL 650-only	<b>O86-22052</b>	<b>47.95</b>
"SDB"	<b>O86-22223</b>	<b>66.95</b>

**Dillon's "Belted Magnum" Powder System** features a maximum-capacity steel powder bar that can dispense more than 100 grains of extruded IMR powder. Magnum rifle cartridges can require from 70 grains to well in excess of 100 grains for a single charge. We tested this system with various extruded rifle powders and found that powder charge variations stayed within plus-or-minus three-tenths of a grain.

Magnum Powder System	<b>O86-97126</b>	<b>\$154.95</b>
----------------------	------------------	-----------------



**Dillon's Bullet Tray** is a simple, shallow aluminum bullet tray designed and located for economy of motion. Our tray works on the Square Deal "B", RL 550 and XL 650 when equipped with the RL 550/XL 650 Strong Mount, and a separate kit is available for the RL/Super 1050.

Bullet Tray Kit	<b>O86-22214</b>	<b>\$44.95</b>
1050 Tray Kit	<b>O86-22215</b>	<b>44.95</b>

**Dillon's Low Powder Sensor** provides an audible and visual reminder when it's time to refill your powder reservoir. When the powder level drops to about 1,000 grains remaining in the reservoir, a buzzer will sound and a bright red LED will light. Designed to fit all Dillon powder measures. Made of clear polycarbonate, it simply replaces the die-cast metal lid supplied with the measure, and operates on two AAA batteries (included).

Low Powder Sensor	<b>O86-16306</b>	<b>\$42.95</b>
-------------------	------------------	----------------



**Dillon's Toolholders** are available for your RL 550, XL 650, SL 900, and Square Deal B, and ensure that the tools you need to service your reloader are handy and organized. No more digging around your bench trying to find the right size hex wrench!

XL 650 with Wrench Set	<b>O86-11555</b>	<b>\$30.95</b>
XL 650 w/o Wrench Set	<b>O86-11554</b>	<b>19.95</b>
RL 550 with Wrench Set	<b>O86-11541</b>	<b>29.95</b>
RL 550 w/o Wrench Set	<b>O86-11543</b>	<b>18.95</b>
Square Deal B with Wrench Set	<b>O86-19441</b>	<b>27.95</b>
Dipped Ball-End Hex Wrenches	<b>O86-11483</b>	<b>18.95</b>
One-Inch Bench Wrench	<b>O86-10842</b>	<b>7.95</b>
Square-Deal-Only Wrench	<b>O86-19970</b>	<b>8.95</b>

**Dillon's Roller Handle** gives your reloader an entirely new "feel," reduces operator fatigue, and makes primer seating easier.

Aluminum Roller Handle	<b>O86-17950</b>	<b>\$47.95</b>
------------------------	------------------	----------------



**Quick-Change Cover** for use with powder measure.

Quick-Change Cover	<b>O86-11143</b>	<b>\$14.95</b>
--------------------	------------------	----------------



**With Dillon's RL 450 Upgrade components**, you can, either all at once or one assembly at a time, upgrade your RL 450 reloader to an RL 550!

**RL 450 Upgrade Components**

Frame Change	<b>O86-20094</b>	<b>\$109.95</b>
Powder Failsafe	<b>O86-20251</b>	<b>95.95</b>
Auto Prime	<b>O86-20055</b>	<b>94.95</b>
Auto Eject	<b>O86-20002</b>	<b>61.95</b>
Primer Warning	<b>O86-20302</b>	<b>26.95</b>

## Dillon's Stainless Steel Headspace Case Gages



.223 Remington	<b>O86-13254</b>	<b>\$26.95</b>
.308 Winchester	<b>O86-12867</b>	<b>27.95</b>
.30-06 Springfield	<b>O86-12679</b>	<b>28.95</b>
.380 ACP	<b>O86-15160</b>	<b>15.95</b>
9mm Parabellum	<b>O86-15161</b>	<b>15.95</b>
.38 Super	<b>O86-15158</b>	<b>15.95</b>
.38 Special	<b>O86-15159</b>	<b>15.95</b>
.357 Magnum	<b>O86-15163</b>	<b>15.95</b>
.40 S&W	<b>O86-15164</b>	<b>15.95</b>
10mm	<b>O86-15162</b>	<b>15.95</b>
.44 Magnum	<b>O86-15165</b>	<b>15.95</b>
.45 ACP	<b>O86-15166</b>	<b>15.95</b>
.45 Colt	<b>O86-15167</b>	<b>15.95</b>
.45 GAP	<b>O86-12672</b>	<b>15.95</b>

## L. E. Wilson Case Gages, Deburring Tool

.22-250	<b>O86-12718</b>	<b>\$36.00</b>
.243	<b>O86-12828</b>	<b>36.00</b>
.25-06	<b>O86-11760</b>	<b>36.00</b>
.270	<b>O86-11828</b>	<b>36.00</b>
6.5 Creedmoor	<b>O86-12108</b>	<b>36.00</b>
6.8 SPC	<b>O86-19522</b>	<b>36.00</b>
7mm Mag.	<b>O86-12336</b>	<b>46.00</b>
.30-30	<b>O86-12924</b>	<b>36.00</b>
.300 AAC Blackout	<b>O86-19515</b>	<b>36.00</b>
.300 Win. Mag.	<b>O86-11752</b>	<b>46.00</b>
.300 WSM	<b>O86-18709</b>	<b>36.00</b>
.357 SIG	<b>O86-18708</b>	<b>36.00</b>
.38-40 Winchester	<b>O86-10682</b>	<b>36.00</b>
.44-40 Winchester	<b>O86-10697</b>	<b>36.00</b>
.50 Browning MG	<b>O86-14447</b>	<b>60.00</b>
<b>Deburring Tool</b>	<b>O86-16038</b>	<b>\$20.00</b>

## Hornady's O.A.L. Gauge and Bullet Comparator



**Overall Length Gauge**  
The initial distance a bullet must travel when fired (from the cartridge case mouth until it engages the rifling) is absolutely critical to achieving peak accuracy.

Straight	<b>O86-14622</b>	<b>\$38.95</b>
Curved (for auto, lever and pump rifles)	<b>O86-14862</b>	<b>\$39.95</b>

**Modified Case** (required)  
\$6.99 each

.223 Rem.	<b>O86-14627</b>
.22-250	<b>O86-14628</b>
.243 Win.	<b>O86-14631</b>
.270 Win.	<b>O86-14641</b>
7mm Rem. Mag.	<b>O86-14648</b>
.308 Win.	<b>O86-14652</b>
.30-06	<b>O86-14653</b>
.300 Win. Mag.	<b>O86-14655</b>

**Bullet Comparator**  
Correct bullet seating depth is critical to accuracy. In addition, minor variations in bullet seating depth will have an effect on both pressure and velocity.

Bullet Comparator	<b>O86-14670</b>	<b>\$16.95</b>
-------------------	------------------	----------------

**Comparator Insert** (required)  
\$8.95 each

.22 caliber	<b>O86-14672</b>
.24 caliber	<b>O86-14673</b>
.25 caliber	<b>O86-14674</b>
.26 caliber	<b>O86-14675</b>
.27 caliber	<b>O86-14676</b>
.28 caliber	<b>O86-14677</b>
.30 caliber	<b>O86-14678</b>
.33 caliber	<b>O86-14679</b>
.35 caliber	<b>O86-14680</b>
.37 caliber	<b>O86-14681</b>
.45 caliber	<b>O86-14682</b>

### A Casefeeder UPGRADE for YOUR RL 550

**\$279.95\***

110 Volt US Model  
 Large Pistol **O86-14450**  
 Small Pistol **O86-14451**  
 220 Volt Euro Model, \$289.95  
 Large Pistol **O86-14453**  
 Small Pistol **O86-14454**  
 \*Caliber Conversions sold separately below.

### RL 550 Casefeeder Caliber Conversions

**\$25.95 Each**

.25-20/.32-20 Winchester	<b>O86-14206</b>
.30 Mauser/7.62x25	<b>O86-14204</b>
.32 S&W Long	<b>O86-14205</b>
.32 H&R Magnum	<b>O86-14283</b>
9mm/9x21/.38 Super/.30 Luger	<b>O86-14284</b>
10mm/9x25 Dillon	<b>O86-14285</b>
.38 S&W	<b>O86-14208</b>
.38 Super Comp.	<b>O86-14287</b>
.38/.357 Magnum	<b>O86-14286</b>
.357 SIG/.40 S&W	<b>O86-14289</b>
.38-40/.44-40 Winchester	<b>O86-14288</b>
.41 Magnum	<b>O86-14290</b>
.44 Russian	<b>O86-14209</b>
.44 Special/Magnum/Colt	<b>O86-14291</b>
.45 GAP	<b>O86-11441</b>
.45 ACP/.40 Super/.400 Cor-Bon	<b>O86-14292</b>
.45 Auto Rim	<b>O86-19140</b>
.45 Colt/.45 S&W/.454 Casull	<b>O86-14279</b>
.45 Winchester Magnum	<b>O86-14210</b>

**WARNING:** The products offered for sale in this catalog can expose you to chemicals, including Lead, which are known to the State of California to cause cancer, birth defects or other reproductive harm. For more information, go to [www.P65Warnings.ca.gov](http://www.P65Warnings.ca.gov).

# Dillon's Case Preparation Equipment



**CV-2001<sup>^</sup> 086-20493 \$189.95**

### CV-2001 – The Industry Standard

Dillon's CV-2001 Vibratory Case Cleaner is one of the largest in the industry. Its 12-1/2 quart bowl capacity will allow you to polish up to 1,300 .38/.357 or 550 .30-06 cases per hour.

Not only is our capacity greater than most, but our motor is also larger in horsepower, internally cooled, thermally protected, and turns on precision ball bearings. This is no "hobby" machine!

The bowl and base are constructed of 7/32" thick injection molded high-strength polypropylene which is impact and abrasion resistant.

### Case/Media Separators

After we sold thousands of our famous first generation FL-2000 case cleaners, customers who had purchased them began asking us to address the problem of separating the cleaned and polished brass from the cleaning media.

We knew from the beginning that the simplest method of separating would be a rotating squirrel cage, but we had to find a design we could manufacture economically. Our problem was that it had to be BIG – big enough to handle the entire load of the FL-2000 series case cleaners.

The solution was an injection molded reversible part. Simple, and it works great. Our device is large, 10" x 14", and will hold more than 1,600 .38 Special cases. It sits on a large media collection tub that measures 18" x 22". The tub keeps the mess off the floor and bench.

It's fast – so fast it will remove media from 1500 rounds of .223 brass in a matter of seconds.



**CV-750<sup>^</sup> 086-19455 \$145.95**

### Limited Work Space?

Dillon's introducing the new CV-750 heavy duty Vibratory Case Cleaner for those with limited space. This new case cleaner uses the same motor as the CV-2001 and is every bit as tough – just more compact. To



**CM-2000 Case/Media Separator<sup>^</sup> 086-20675 \$76.95**  
**CM-500 Case/Media Separator<sup>^</sup> 086-21045 \$47.95**

accompany the CV-750, the CM-500 does the same job as the larger CM-2000 Case/Media Separator; and, like the CV-750, handles just about half the capacity of the larger unit.

Although scaled down in size, these two pieces of equipment are every bit as tough as their full-sized counterparts. We used the same materials in their construction and designed them to work just as hard – and do it in a more compact area!

### Attention European Customers: Case Cleaners are available in 220 volt!

- Euro CV-2001 086-22047 \$214.95
- Euro CV-750 086-19473 \$170.95

**WARNING:** The products offered for sale in this catalog can expose you to chemicals, including Lead, which are known to the State of California to cause cancer, birth defects or other reproductive harm. For more information, go to [www.P65Warnings.ca.gov](http://www.P65Warnings.ca.gov).

## Rapid Polish<sup>^</sup>



SHINE? You bet your brass! Dillon Precision has developed another exciting new product to make your reloading faster and easier. Rapid Polish 290 is the first cartridge case finish designed specifically to bring a brilliant shine (20 percent brighter than tumbling media alone) and a protective coating to reloaded ammunition. Simply add several capfuls to the media in your tumbler and run.

Rapid Polish 290 has a great residual value and stays in your tumbling media. You'll use less each time you clean your cases.

*Rapid Polish 290 contains no ammonia, so it won't weaken brass cases!*

- 8 oz. bottle. **086-13804 \$8.95**
- Case (20 pc.) **086-20255 135.95**



## Case Lube<sup>^</sup>

Rapid Lube 5000, Dillon's aerosol cartridge case lubricant, has been replaced by an "environmentally correct," non-aerosol case lube. It works the same: Simply lay your cases out, spray lightly with one or two passes and you've done it. No mess, no guesswork. Within minutes the lubricant distributes itself around the cartridge cases and you're ready to load. Try a bottle. You'll never use a grease pad again.

*D.C.L. Dillon Case Lubricant*

- 8 oz. bottle **086-13733 \$11.95**
- Case (20 pc.) **086-20256 168.00**

- Half and Half** 10 bottles of polish /10 of lube<sup>^</sup>
- Case (20 pc.) **086-21375 \$135.95**

## Don't Forget Polishing Media!

Crushed walnut hull polishing media – quickly cleans even the dirtiest of cases.  
15-pound bag **086-13287 \$23.95**

Ground corn cob polishing media – the best there is for that final polish.  
10-pound bag **086-13496 \$15.95**



This month's cover model is Jessica. To see more photos of Jessica and other **Blue Press** cover models, you can "follow" us on **Instagram@bluepress** on your smartphone, or go to [www.instagram.com/bluepress](http://www.instagram.com/bluepress) and click "follow."

# 20 XL 650<sup>^</sup>

## STANDARD FEATURES:

- Automatic Indexing
- Uses Standard 7/8" x 14 Dies
- Loading Rate: 500-800 Rds./Hr.
- Comes With One Caliber Conversion
- 5-Station Interchangeable Toolhead
- Automatic Powder Measure
- Automatic Primer System
- Lifetime "No-B.S." Warranty
- **RISK FREE 30-Day Trial!**

All for ONLY...  
**\$589<sup>95\*</sup>**

086-650

Reloading dies sold separately.  
\*Prices vary on exotic-caliber machines.



**XL 650 DVD**  
Instruction Manual<sup>^</sup>  
086-19484 \$19.95

Total price as pictured here with optional accessories: \$1188.55

Electric Casefeeder	086-210**	\$239.95
Powdercheck System	086-21044	\$70.95
.45 ACP Die Set	086-14404	\$69.95
Strong Mount (550/650)	086-22051	\$50.95
Roller Handle	086-17950	\$47.95
Low Powder Sensor	086-16306	\$42.95
Bullet Tray	086-22214	\$44.95
Toolholder w/Wrench Set	086-11555	\$30.95

## XL 650 Accessories

### A. XL 650 CALIBER CONVERSION KITS<sup>^</sup>

Include shellplate, locator buttons, powder funnel and casefeed adapter parts. Available in most calibers; please specify caliber desired.

(You MAY need a different casefeed plate, see item L.)

**O86-XL650 CONVERSION (Specify Caliber) \$79.95\***  
\*(All belted magnums and exotic calibers, \$89.95 ea.)

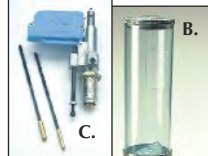

**B. POWDER MEASURE<sup>^</sup>**  
O86-20782, \$84.95 each  
Magnum Rifle Powder Bar  
O86-21353, \$32.95 each  
X-Small Powder Bar  
O86-20780, \$32.95 each

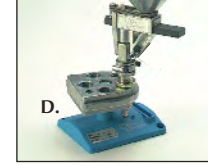

**C. POWDER CHECK<sup>^</sup>**  
O86-21044, \$70.95 each  
Three or more, \$63.95 ea.

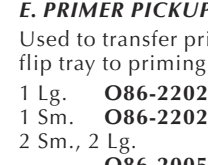

**D. QUICK CHANGE<sup>^</sup>**  
Toolhead, TH Stand and Powder Measure  
O86-22059, \$116.95

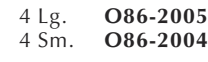

**E. PRIMER PICKUP TUBES**  
Used to transfer primers from flip tray to priming system.  
1 Lg. O86-22029 \$7.99  
1 Sm. O86-22028 7.99  
2 Sm., 2 Lg. O86-20056 25.95  
4 Lg. O86-20050 25.95  
4 Sm. O86-20049 25.95

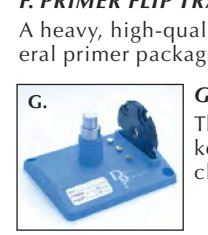

**F. PRIMER FLIP TRAY**  
A heavy, high-quality tray large enough for the Federal primer package. O86-13606, \$22.95 ea.

**G. TOOLHEAD STANDS**  
The ultimate in convenience for keeping your reloading bench clean and uncluttered.  
O86-22055, \$22.95 each  
Three or more, \$20.95 ea.

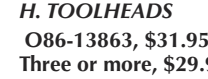

**H. TOOLHEADS**  
O86-13863, \$31.95 each  
Three or more, \$29.95 ea.

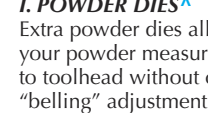

**I. POWDER DIES<sup>^</sup>**  
Extra powder dies allow you to move your powder measure from toolhead to toolhead without changing the "belling" adjustment.  
O86-20064, \$12.95 each, three or more, \$11.95 ea.  
X-Large Powder Dies, O86-21253, \$19.95 each



**J. XL 650 PRIMING SYSTEM<sup>^</sup>** (Not Pictured)  
Small Priming System O86-21065 \$84.95  
Large Priming System O86-20982 84.95

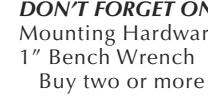

**Q. LOW POWDER SENSOR<sup>^</sup>**  
Provides an audible and visual reminder when it's time to refill your powder reservoir.  
O86-16306, \$42.95

**K. CASEFEED ASSEMBLY<sup>^</sup>**  
Specify large pistol, small pistol, large rifle or small rifle.  
\$239.95 (110v),  
\$249.95 (Euro. 220v)



**L. EXTRA CASEFEED PLATES<sup>^</sup>**  
\$39.95/50.95

**XL 650 Casefeed Assembly**  
Large pistol (110v) O86-21080 (Euro. 220v) O86-97025  
Large rifle (110v) O86-21081 (Euro. 220v) O86-97022  
Small pistol (110v) O86-21079 (Euro. 220v) O86-97021  
Small rifle (110v) O86-21082 (Euro. 220v) O86-97023

**XL 650 Casefeed Plate<sup>^</sup>**  
Large pistol O86-21072 \$39.95  
Large rifle O86-21075 39.95  
Magnum rifle O86-18492 50.95  
Small rifle O86-21074 39.95  
Small pistol O86-21073 39.95



**M. MACHINE MAINTENANCE KIT<sup>^</sup>**  
Everything you need to keep your Dillon loader cleaned and lubricated up to factory specifications. Available in combination with a spare parts kit for your machine.

Maint. Kit & Spare Parts Kit O86-97017, \$41.95

**N. SPARE PARTS KIT<sup>^</sup>**  
1 Priming Station Locator Tab  
1 650 Ejector Wire  
1 Slide Spring Pin  
1 Indexer Spring  
1 650 Primer Indexing Arm  
1 650 Index Pawl  
1 650 Primer Cam  
1 650 Ring Indexer  
2 Pistol Decapping Pins  
1 650 Index Spring Revision A  
1 #10 Tinnerman Insert  
1 Index Arm Bowed Washer  
1 Short Lever Spring  
1 Bellcrank Cube  
1 3/8" Index Ball  
1 Powder Bar Spacer Plug  
1 650 Brass Tip Set Screw  
4 Locator Pins (#1, #2, #3, #4)  
1 5/16" Index Ball  
1 Tab/Spring Arm Spring  
1 Case Insert Slide Spring  
1 650 Pawl Spring  
1 Indexing Arm Spring  
1 Index Ball Spring



2 Pickup Tube, Small, Yellow Tips  
1 650 Tool Head Pin  
2 Pickup Tube, Large, Green Tips  
1 Primer Cup Spring  
2 Retaining Clips  
2 650 Shellplate Cap  
1 650 Primer Support Shim  
1 Case Insert Slide Spring Cap  
1 Priming Station Locator Tab Bushing  
2 Dispensing Tips, Large  
2 Dispensing Tips, Small  
1 Failsafe Bushing Revision B  
O86-21146, \$27.95

**O. EQUIPMENT DUST COVERS<sup>^</sup>**  
This packcloth nylon machine cover comes equipped with a D-ring, allowing the heavy-duty zipper to be locked.  
XL 650 Cover, O86-10443, \$39.95  
(P.) Master lock, O86-13083, \$3.95  
Quick-Change Cover (for use with powder measure) O86-11143, \$14.95



**WARNING:** The products offered for sale in this catalog can expose you to chemicals, including Lead, which are known to the State of California to cause cancer, birth defects or other reproductive harm. For more information, go to [www.P65Warnings.ca.gov](http://www.P65Warnings.ca.gov).

## 22 Color Coded Aluminum RL 550/XL 650 Toolheads



Blue RL 550 Toolhead	<b>086-62132</b>	<b>\$29.95</b>
Black RL 550 Toolhead	<b>086-62133</b>	<b>29.95</b>
Gold RL 550 Toolhead	<b>086-62134</b>	<b>29.95</b>
Silver RL 550 Toolhead	<b>086-62135</b>	<b>29.95</b>
Blue XL 650 Toolhead	<b>086-62136</b>	<b>34.95</b>
Black XL 650 Toolhead	<b>086-62137</b>	<b>34.95</b>
Gold XL 650 Toolhead	<b>086-62138</b>	<b>34.95</b>
Silver XL 650 Toolhead	<b>086-62139</b>	<b>34.95</b>

## Super 1050/RL 1050 Short Trim Die Toolhead ^



**086-62219**  
**\$229.95**

For short rifle cartridges like the .300 Blackout, you must use a Short Trim Die Toolhead when using a Dillon Rapid Trim 1500 Case Trimmer during case preparation. Otherwise, the toolhead is too thick to facilitate the correct case length. This specialty toolhead enables you to correctly trim and prepare short rifle cases on your 1050. (NOTE: the Blue 1050 toolhead stand - Part Number 086-62200, \$49.95 - is not included.)

## Rapid Trim 1500 Case Trimmer ^ 23



Dillon's RT 1500 shown installed on an XL 650.

The RT 1500 is used just like a standard size die. The big difference is that while you are pushing the case into the die to size it, an electric motor driving a carbide cutter at 4500 RPM is trimming the case to length. Chips are drawn off through a vacuum manifold that clamps to the outside of the special size/trim die. (Vacuum cleaner and hose not included.) The RT 1500 is equipped with a

quick-disconnect power cord; and it can be used on any standard reloader, single stage or progressive.

The RT 1500 Case Trimmer **086-62164** is **\$332.95**. (Available only in 110 volt 60 Hz.) Size/trim dies are sold separately (see chart below). Replacement carbide cutting blades, **086-13141**, are **\$20.95** each. Upper lock rings, **086-13559**, are **\$5.99** each.

### RT 1500 & 1200B Size/Trim Die Calibers ^

.204 Ruger	<b>086-21028</b>	<b>\$59.95</b>
.222 Rem.	<b>086-21363</b>	<b>59.95</b>
.223 Rem.	<b>086-20107</b>	<b>52.95</b>
.223 Rem. Carbide	<b>086-19797</b>	<b>186.95</b>
.220 Swift	<b>086-21364</b>	<b>59.95</b>
.22-250 Rem.	<b>086-20110</b>	<b>57.95</b>
.243 Win.	<b>086-20109</b>	<b>57.95</b>
.25-06 Rem.	<b>086-21367</b>	<b>59.95</b>
6.5 Creedmoor	<b>086-62290</b>	<b>59.95</b>
6.5 x 55mm	<b>086-21495</b>	<b>59.95</b>
.270 Win.	<b>086-20112</b>	<b>57.95</b>
7mm Rem. Mag.	<b>086-21366</b>	<b>59.95</b>
.30-30 Win.	<b>086-20111</b>	<b>57.95</b>
.300 WSM	<b>086-21029</b>	<b>59.95</b>
.308 Win.	<b>086-20106</b>	<b>52.95</b>
.308 Win. Carbide	<b>086-62126</b>	<b>186.95</b>
.30-06	<b>086-20108</b>	<b>52.95</b>
.30-06 Carbide	<b>086-62159</b>	<b>236.95</b>
.300 Win. Mag.	<b>086-21370</b>	<b>59.95</b>
.300 Wby. Mag.	<b>086-21371</b>	<b>59.95</b>
.303 Brit.	<b>086-21765</b>	<b>59.95</b>
8 x 57 Mauser	<b>086-21502</b>	<b>59.95</b>
.338 Win. Mag.	<b>086-21368</b>	<b>59.95</b>
RT 1500 Motor Only	<b>086-61500</b>	<b>\$301.95</b>

### RT 1500 Short Trim Dies

NOTE: The following dies MUST be used with a Short Trim Die Toolhead.

.300 Blk Carbide	<b>086-62140</b>	<b>\$186.95</b>
6.8 SPC	<b>086-62238</b>	<b>\$59.95</b>
7.62 x 39	<b>086-62237</b>	<b>59.95</b>



### Short Trim Die Toolheads

RL 550	<b>086-62231</b>	<b>\$39.95</b>
(Includes modified vacuum manifold.)		
XL 650	<b>086-62112</b>	<b>35.95</b>
RL/Super 1050 ^	<b>086-62219</b>	<b>229.95</b>

(Not pictured, see Page 22.)

## Lyman Precision Funnel Set



Lyman's Precision Funnel Set is the ideal system for the serious reloader. The Precision Funnel Set is made to be completely static free, with a body of die-cast aluminum and precision-turned aluminum inserts. No more powder clinging to surfaces, which can happen with lightweight plastic funnels. The solid construction and quality of Lyman's Precision Funnel Set will be apparent in its first use. This is no "one size fits all" funnel; the Precision Funnel Set uses precision-machined, caliber-specific inserts to properly fit the case neck. The inserts can be quickly and easily installed by simply pushing them into place and then pulling them out when changing calibers. The Precision Funnel Set also comes with a padded storage case that neatly stores extra inserts when not in use. The set includes inserts for .22, .243/6mm, .25/6.5mm, .270/7mm, .30 and .338 caliber rifle cartridges.

**086-11389 \$39.95**

## Lyman X-Block Gunsmith Bench Block



Having the right tool for the job makes any gunsmithing project so much easier! Without the right tool, you may damage fine finishes or break parts. The Lyman X-Block is the right tool for anyone driving pins out of firearms. It has all the features to get the job done smoothly and professionally. The X-Block has both a "V" slot and a rounded slot running across the face of the block to support a variety of barrels and slides. The block is made of a tough, non-marring polymer, and edged with a softer non-slip outer overmold. The block has multiple holes to take on most any project, as well as a molded-in magnet on the back side of the block to catch pins and other small parts as they drop out. Its large 5" diameter provides a stable base with plenty of support.

**086-11390 \$15.95**

## MILITARY BRASS?

Eliminate the "Grunt Work" with Dillon's Super Swage 600 ^

Until now, reusing military brass, with its crimped primer pockets, has been a tedious task. The Dillon solution is a remarkably simple device that bolts to your bench and allows you to swage the primer pockets with speed and ease. The case is supported from the inside, so you won't be tearing the rims off the brass. A tool steel, hardened swage rod (easy to change from large to small primers) simply rolls the crimp away. No reaming is necessary. Our unique compound cam leverage system assures not only ease of operation, but perfect alignment with each and every round. Sound simple? It is and it works. What's more, it's inexpensive. The Super Swage 600 comes with large and small swage rods.



**086-20095**  
**\$106.95**

6.8 SPC Back-Up Rod	<b>086-62124</b>	<b>\$20.95</b>
9mm Adaptor	<b>086-62168</b>	<b>14.95</b>
.40 S&W Adaptor	<b>086-62169</b>	<b>14.95</b>

**WARNING:** The products offered for sale in this catalog can expose you to chemicals, including Lead, which are known to the State of California to cause cancer, birth defects or other reproductive harm. For more information, go to [www.P65Warnings.ca.gov](http://www.P65Warnings.ca.gov).

# Dillon Leather by Mitch Rosen!



**El Raton-DL \$50**  
 This pocket holster secures and properly positions a J-Frame revolver in your pocket. Will not come out when you draw.  
 2" J-Frame S&W Revolver **O86-18843**

**5JR-DL \$75**  
 A full-length belt slide that offers all-day comfort and superior concealment for an outside-the-pants belt holster.

Beretta 92	<b>O86-18817</b>
Colt Government Model	<b>O86-18810</b>
Colt Commander	<b>O86-18811</b>
Colt Officers	<b>O86-18812</b>
GLOCK 17, 22, 31	<b>O86-18813</b>
GLOCK 19, 23, 32	<b>O86-18814</b>
GLOCK 26, 27, 33	<b>O86-18815</b>

When we lost our supplier for Dillon Leather, we considered abandoning the gunleather business. Fortunately, we were able to team up with Mitch Rosen Extraordinary Gunleather to continue to offer a best-quality, made-in-the-USA line of belts and holsters. We know you'll like these products – we're happy to have our name on them.

GLOCK 20, 21	<b>O86-18816</b>
GLOCK 42	<b>O86-10034</b>
GLOCK 43	<b>O86-10035</b>
SIG P220, P226	<b>O86-18818</b>
SIG P228, P229	<b>O86-18827</b>
SIG P320 4.7"	<b>O86-10032</b>
SIG P365	<b>O86-10033</b>
S&W Military & Police 9mm/.40 Auto	<b>O86-19011</b>
S&W Military & Police SHIELD™	<b>O86-12241</b>
S&W 2" J-Frame Revolver	<b>O86-18820</b>
Ruger 2.25" SP-101 Revolver	<b>O86-18828</b>

**Sport EXP-DL \$98**  
 The Sport™ holster is a straight-drop design featuring a tunnel loop and rear stabilizing slot. This is an all-around holster suited to field use, "practical" competition, and some prefer it for daily carry. Slim profile, straight drop, close to the body.

S&W 4" K-Frame Revolver	<b>O86-19372</b>
S&W 4" Lugged Barrel L-Frame Revolver	<b>O86-19373</b>
S&W 4" Light Barrel N-Frame Revolver	<b>O86-19374</b>
S&W 4" Lugged Barrel N-Frame Revolver	<b>O86-19375</b>
S&W 5" Lugged Barrel N-Frame Revolver	<b>O86-19376</b>

**Best-Quality Belt-DL \$70**  
 Simply the best GUN BELT you have ever owned. Full, double-thickness leather with solid brass buckle and hardware.

1.5" Gun Belt		1.25" Gun Belt	
32" Waist	<b>O86-18859</b>	32" Waist	<b>O86-18873</b>
34" Waist	<b>O86-18860</b>	34" Waist	<b>O86-18867</b>
36" Waist	<b>O86-18861</b>	36" Waist	<b>O86-18868</b>
38" Waist	<b>O86-18862</b>	38" Waist	<b>O86-18869</b>
40" Waist	<b>O86-18863</b>	40" Waist	<b>O86-18870</b>
42" Waist	<b>O86-18864</b>	42" Waist	<b>O86-18871</b>
44" Waist	<b>O86-18865</b>	44" Waist	<b>O86-18872</b>



## Tuff Products Mag Pouches



Tuff Products Magazine Pouches are the most versatile we've ever seen. They can be worn on a belt or attached to anything that has a MOLLE fastener system. Available in black or coyote brown.

Black 8-Magazine Single-Stack (1911)	<b>O86-19854</b>	<b>\$39.95</b>
Brown 8-Magazine Single-Stack (1911)	<b>O86-19855</b>	<b>39.95</b>
Black 5-Mag. Double-Stack (9/.40 GLOCK)	<b>O86-19856</b>	<b>39.95</b>
Brown 5-Mag. Double-Stack (9/.40 GLOCK)	<b>O86-19857</b>	<b>39.95</b>

## Comp-Tac PCC PLM Mag Pouch

The Comp-Tac Pistol Caliber Carbine Magazine Pouch – PLM – is an outside-the-waistband holder to carry a spare magazine for competition. The smooth, low-friction surface allows for a fast magazine removal and easy one-handed insertion of the magazine. "RH" pouches are designed to be worn on the left side, bullets forward; "LH" pouches on the right side, bullets forward.



Colt/UMC 9mm RH	<b>O86-10047</b>	<b>\$37.99</b>
Colt/UMC 9mm LH	<b>O86-10051</b>	<b>37.99</b>
CZ Scorpion RH	<b>O86-10049</b>	<b>37.99</b>
CZ Scorpion LH	<b>O86-10053</b>	<b>37.99</b>
GLOCK 9/40 RH	<b>O86-10050</b>	<b>37.99</b>
GLOCK 9/40 LH	<b>O86-10054</b>	<b>37.99</b>
SIG MPX RH (pictured above)	<b>O86-10048</b>	<b>37.99</b>
SIG MPX LH	<b>O86-10052</b>	<b>37.99</b>

# 26 Dillon's Concealed Carry Tote<sup>^</sup>

Dillon's NEW Concealed Carry Tote accommodates all the tools you need to survive the urban jungle. This low-profile carry case looks like an ordinary briefcase or laptop case, but it's designed for your pistol as well as your PC! It's made of rugged nylon fabric, with heavy-duty zippers on all compartments. The main compartment is 15" x 11.5" x 3" deep, with pouches in back and front. The hidden gun pocket is held closed with hook & loop fasteners for quick access, has a 14.5" opening and is 10.5" deep. The two front pockets are 6.5" x 8" x 1.5" and feature inner pockets for flat items. There is also a zippered compartment on the back of the case sized to accommodate a ballistic armor plate.



\$59<sup>95</sup>  
086-17001

# Mernickle

## Conceal-Carry Performance Series

Conceal-Carry Performance Series revolver holsters can be worn strong side, appendix carry or cross draw and are fully molded. Auto holsters are strong-side only.

- 4-3/4" SA Colts/clones **O86-11560**
- 4-5/8" Ruger Blackhawk **O86-15765**
- Ruger LCR **O86-29030**
- 2" J-Frame S&W Rev. **O86-15764**
- GLOCK 17/22 **O86-62277**
- GLOCK 19/23 **O86-62278**
- 5" 1911 (pictured) **O86-62279**
- 4" 1911 **O86-62288**



\$79<sup>95</sup>

# Mernickle's "Wild Bunch" 1911 Holster/Mag Pouch

This holster/mag pouch combination was designed specifically for the Single Action Shooting Society's "Wild Bunch" category of Cowboy Action Shooting, incorporating a holster and mag pouch that look like they were made at the turn of the century, yet feature state-of-the-art speed and accuracy. The holster is hard molded so as not to lose its shape even after thousands of draws. It spaces the pistol's grip frame away from your body so you'll get a full combat grip, and the holster includes

the T-nut lock system to ensure that it stays in place during a draw.

The mag pouch spaces the magazines so when you grab one mag, the second isn't in your way; above the belt line so the belt doesn't interfere with the draw; and at the max depth required by the sport – and no more – so you'll get a full grip and the ability to index with your forefinger for a rapid mag well insert.

- 1911 Holster **O86-19947 \$139.95**
- Mag Pouch **O86-19946 44.95**



# 5.11 Tactical<sup>®</sup> ALWAYS BE READY<sup>27</sup>



Double Duty TDU<sup>®</sup>



Trainer



Operator

The Double Duty TDU<sup>®</sup> belt is metal-detector friendly and offers two color options. Both the Trainer and Operator belts feature 6,000-pound-test buckles and heavy, reinforced stitching, therefore can be quickly converted into secure tie downs, secondary carry straps or emergency harnesses. All 5.11 tactical belts are made of strong nylon webbing and provide a stable support for carrying firearms and accessories. According to 5.11 Tactical, belt sizes run small, so they recommend you order one size up for the best fit.

## 5.11<sup>®</sup> Double Duty TDU Reversible 1.5" Belt

Waist Size	1.5" TDU <sup>®</sup>	
Small 28-30"	O86-21599	\$22.95
Medium 32-34"	O86-21600	22.95
Large 36-38"	O86-21601	22.95
X-Large 40-42"	O86-21602	22.95
2X-Large 44-46"	O86-21603	25.95
3X-Large 48-50"	O86-21604	25.95

## 5.11<sup>®</sup> 1.5" Trainer Belt & 1.75" Operator Belt

Waist Size	1.5" Trainer	1.75" Operator	
Sm. 28-30"	O86-21613	O86-21606	\$39.99
Med. 32-34"	O86-21614	O86-21607	39.99
Lg. 36-38"	O86-21615	O86-21608	39.99
X-Lg. 40-42"	O86-21626	O86-21609	39.99
2X-Lg. 44-46"	O86-21627	O86-21610	44.99
3X-Lg. 48-50"	O86-21628	O86-21611	44.99
4X-Lg. 52-54"	O86-21670	O86-21612	44.99

# BLADETECH Ultimate Carry Belt by Nexbelt



The Blade-Tech Ultimate Carry Belt by Nexbelt is specifically designed for those who carry a firearm daily for personal defense. The PreciseFit ratchet system allows you to quickly tighten or loosen the belt in 1/4" increments up to 6" for the perfect fit – no matter how you carry. Rest assured, this will be the most comfortable and fastest adjusting belt you will ever own. The Ultimate

Carry Belt has a water-resistant backing that helps prevent moisture from penetrating the outer surface and allows for extra strength and durability. **One size – adjusts to fit all.**

- Titan Black Nylon 1.5" **O86-12380 \$49.99**
- Titan Brown Nylon 1.5" **O86-12383 49.99**
- Defender Black Leather **O86-12384 59.99**
- Defender Brown Leather **O86-12385 59.99**

# BLADETECH Special Purchase!

The folks at Blade-Tech made these holsters for a firearms manufacturer's special order, and these are the overruns. They'll accommodate 1911s with or without accessory rails.

**O86-13079 \$19.95**



# INTERNATIONAL HANDGUN LEATHER



Belt Size	\$58.95	
1911 Black	O86-16468	
Sm. Glock, Blk.	O86-16469	

Speed Strip Wallet	Speed Strip/ Ammo NOT Included	
.38/.357 6-rd.	O86-18308	\$31.95
.38/.357 8-rd.	O86-18987	31.95
.44/.45 6-rd.	O86-18988	31.95
.410 Ga. 6-rd.	O86-18990	35.95
.500 S&W 6-rd.	O86-18989	31.95

# BLADE-TECH™

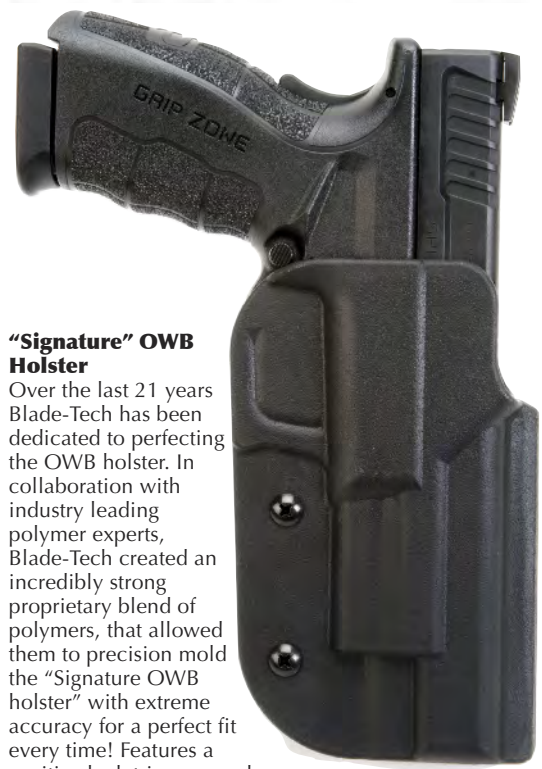

### "Signature" OWB Holster

Over the last 21 years Blade-Tech has been dedicated to perfecting the OWB holster. In collaboration with industry leading polymer experts, Blade-Tech created an incredibly strong proprietary blend of polymers, that allowed them to precision mold the "Signature OWB holster" with extreme accuracy for a perfect fit every time! Features a positive lock trigger guard, adjustable retention screws and Tek-Loc™.

Colt 1911 R/NR (rail or no rail)	O86-40148	\$34.99
CZ 75 3.75" SP01	O86-10038	34.99
GLOCK 17/22	O86-40140	34.99
GLOCK 19/23	O86-40139	34.99
GLOCK 20/21	O86-40142	34.99
GLOCK 34/35	O86-40141	34.99
SIG 4.7" P320/X5	O86-10036	34.99
Smith & Wesson 4" M&P	O86-40149	34.99
S&W 4.25" M&P 2.0	O86-10037	34.99
Springfield 4" XD/Mod 2 9/40	O86-40143	34.99
Springfield 5" XD/Mod 2 9/40	O86-40144	34.99
Springfield 4.5" XDM	O86-40145	34.99
Springfield 5.25" XDM	O86-40146	34.99
STI Edge	O86-40147	34.99

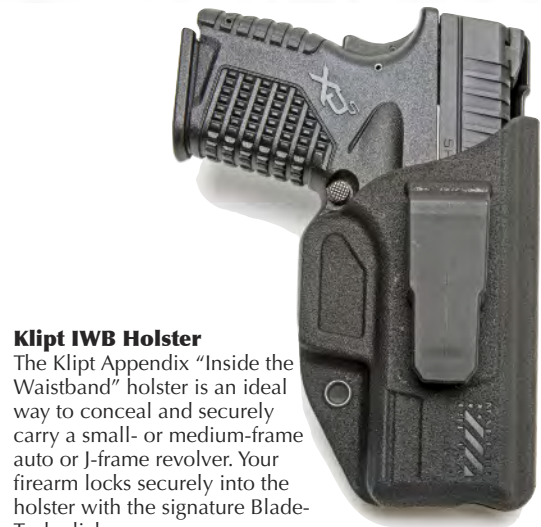

### Klipt IWB Holster

The Klipt Appendix "Inside the Waistband" holster is an ideal way to conceal and securely carry a small- or medium-frame auto or J-frame revolver. Your firearm locks securely into the holster with the signature Blade-Tech click.

GLOCK 42	O86-43396	\$29.99
GLOCK 43	O86-43398	29.99
Ruger LC9	O86-43394	29.99
S&W J-Frame Revolver	O86-43397	29.99
S&W M&P Shield	O86-43395	29.99
Springfield XDS	O86-43393	29.99



### BLADE-TECH 1.5" Inner/Outer Hook & Loop Belt

32"	O86-12242	\$49.99
34"	O86-12243	49.99
36"	O86-12245	49.99
38"	O86-12246	49.99
40"	O86-12247	49.99
42"	O86-12249	49.99
44"	O86-12251	49.99
46"	O86-12253	49.99
48"	O86-12255	49.99



**Single Mag** \$19.99 ea.  
 1911 O86-40150  
 Small GLOCK O86-40151  
 Large GLOCK O86-40152  
 Double-Stack 9/40 O86-40153  
 Double-Stack .45 O86-40154



**Double Mag** \$29.99 ea.  
 1911 O86-40155  
 Small GLOCK O86-40156  
 Large GLOCK O86-40157  
 Double-Stack 9/40 O86-40158  
 Double-Stack .45 O86-40159



**AR-15 Single Tek-Loc™ Mag Pouch**  
 O86-40034 \$29.99



**Large Tek-Loc™ Universal Belt Clip w/Hardware**  
 O86-40029 \$12.99

# SAFARILAND Holsters



Safariland Custom Fit 567

Safariland Model 6377 ALS™

Colt Officers' Model, GLOCK 19/23, SIG P228, HK USP Compact 9/40 O86-19267 43.95  
 GLOCK 17, 20, 21, 22, HK USP 9/40, Ruger P Series, SIG P220 O86-19268 43.95

### Safariland Model 6377 ALS™ Holsters

The Model 6377 is a concealment version of the all new Automatic Locking System series holster. Once the weapon is holstered, it locks into place, providing an extra measure of security from the standard open-top holster.

Colt 1911	O86-40072	\$39.95
GLOCK 17/22	O86-19444	39.95
GLOCK 20/21	O86-19443	39.95
GLOCK 34/35	O86-40073	39.95
SIG 220/226	O86-19446	39.95
SIG 220/226 with Accessory Rail (no light)	O86-19447	39.95
SIG 228	O86-19445	39.95
S&W M&P 9/40	O86-19448	39.95
Springfield 4" XD 9/40	O86-40074	39.95
Springfield 5" XD 9/40	O86-40075	39.95
Springfield XDM 9mm	O86-40076	39.95
Springfield XDM .40	O86-40077	39.95

### Safariland Custom Fit 567 Holsters

The Model 567 Custom Fit holster is one of the lightest, thinnest, best fitting concealment holsters available. True to its name, it adjusts to a wide variety of popular handguns, giving each a "custom fit" in this holster.

4" K & L-Frame S&W, Ruger, and Colt Revolvers	O86-19262	\$43.95
4" N-Frame S&W Revolvers	O86-19263	43.95
5" N-Frame S&W Revolvers	O86-19264	43.95
Beretta Compact, Taurus Compact, CZ-75, Colt Commander Model	O86-19265	43.95
Beretta, Taurus, Browning HP, Colt 1911	O86-19266	43.95

# Comp-Tac Holsters



### Comp-Tac QB

The QB can be worn as a concealed carry or competition holster. Can be worn left or right handed, has cant adjustability and a high quality Push-Button mount that is easy on, easy off and can be locked for security by sliding the button horizontally. Mount also allows for belt-width adjustment.

**QB Size 1 fits:** GLOCK 9/40/.357 all lengths, GLOCK 41, GLOCK 36; S&W M&P 9/40/.357 all lengths (not Shield); Walther PPK/M2 all lengths O86-43380 \$49.95  
**QB Size 2 fits:** CZ P07, P09; HK VP40, P30, P30L, P30SK, USPs full size and compact, P2000; Ruger American, Ruger SR9 full size and compact; S&W M&P .45s (not Shield); Springfield XD/XDM/Mod 2 all lengths and calibers; GLOCK 20/21 all versions, GLOCK 40; SIG 250 all lengths, with and without rail, all calibers, SIG 320 all lengths, all calibers, SIG 226 all versions, SIG 229 all versions; Taurus all .45 Millennium and Millennium Pro; Walther PPK .45 O86-43381 \$49.95  
**QB Size 3 fits:** GLOCK 43; Springfield XD-S; S&W Shield; Walther PPS; Walther CCP O86-43382 \$49.95  
**QB Size 4 fits:** 1911s - Colt, Kimber, Springfield including TRP Half and Full Rail, SIG 1911s, all Mil-Spec 1911s O86-43383 \$49.95

### Comp-Tac IDPA Revolver Competition Holster

4" K-Frame S&W Revolvers	O86-13029	\$64.99
4" L-Frame S&W Revolvers	O86-13032	64.99
2.5" N-Frame S&W Revolvers	O86-13035	64.99
4" N-Frame S&W Revolvers	O86-13038	64.99

### Comp-Tac USPSA Revolver Competition Holster

6" K-Frame S&W Revolvers	O86-13030	\$64.99
6" L-Frame S&W Revolvers	O86-13033	64.99
5" N-Frame S&W Revolvers	O86-13043	64.99
6.5" N-Frame S&W Revolvers	O86-13044	64.99

# SUPER 1050<sup>^</sup>



## STANDARD FEATURES:

- Loading Rate: 1000-1200 Rds/Hr
- High Strength Ductile Iron Frame
- Swages Military Primer Pockets
- Automatic Indexing
- Automatic Casefeeder
- Automatic Primer System
- Automatic Powder Measure
- Factory Adjusted Reloading Dies
- **RISK FREE 30-Day Trial!**

All for ONLY...  
**\$1811<sup>95\*</sup>**

\*Prices vary on exotic-caliber machines.

## SUPER 1050 Stock Numbers

.380 ACP	O86-21135
9mm Parabellum	O86-21067
.38 Super	O86-21132
.38 Super Comp	O86-21069
.38 Special	O86-21136
.357 Magnum	O86-21137
.40 S&W	O86-21070
10mm	O86-21138
.41 Magnum	O86-21139
.44 Special	O86-21140
.44 Magnum	O86-21141
.45 ACP	O86-21061
.45 Colt	O86-21133
.223 Remington	O86-21130
.223 Rem./Carbide	O86-21131
6.5 Creedmoor	O86-62404
.300 BLK/Carbide	O86-62388
.308 Winchester	O86-21058
.308 Win./Carbide	O86-21068

(See Page 31 for more caliber listings.)

**Super 1050 DVD**  
 Electronic User Guide  
**Instruction Manual<sup>^</sup>**  
 O86-19485 \$19.95

Total price as pictured here  
 with optional accessories: **\$2005.75**

Powdercheck System	O86-21044	\$70.95
Low Powder Sensor	O86-16306	\$42.95
Bullet Tray	O86-22215	\$44.95
1050 Toolholder	O86-62202	\$34.95

## 1050 Accessories

### A(1). QUICK-CHANGE TOOLHEAD CONVERSION<sup>^</sup>

- Includes:**
- Toolhead
  - Powder Measure
- O86-21393, \$281.95



### A(2). CALIBER CONVERSION<sup>^</sup>

- Includes:**
- Shellplate
  - Locator Buttons
  - Swage Backup Rod/Expander
  - Casefeed Adapter
  - Casefeed Plunger
  - Powder Funnel

Pistol Calibers	Conversion#/Price	Machine#/Price
.32 ACP	#20633/\$127.95	#21162/\$1811.95
.32 S&W Long	#20634/\$127.95	#21134/\$1811.95
.32 H&R Magnum	#20634/\$127.95	#21134/\$1811.95
.380 ACP	#20483/\$127.95	#21135/\$1811.95
9mm Parabellum	#20482/\$127.95	#21067/\$1811.95
.38 Super	#20484/\$127.95	#21132/\$1811.95
.38 Super Comp	#21057/\$127.95	#21069/\$1811.95
.38 Special	#20477/\$127.95	#21136/\$1811.95
.357 Magnum	#20477/\$127.95	#21137/\$1811.95
.357 SIG	#20068/\$127.95	#21127/\$1849.95*
.38-40 Winchester	#21160/\$127.95	#21158/\$1811.95
.40 S&W	#20545/\$127.95	#21070/\$1811.95
10mm	#20788/\$127.95	#21138/\$1811.95
.41 Magnum	#20478/\$127.95	#21139/\$1811.95
.44 Special	#20479/\$127.95	#21140/\$1811.95
.44 Magnum	#20479/\$127.95	#21141/\$1811.95
.44-40 Winchester	#21161/\$127.95	#21159/\$1811.95
.45 GAP	#21010/\$127.95	#21002/\$1811.95
.45 ACP	#20480/\$127.95	#21061/\$1811.95
.45 Colt	#20481/\$127.95	#21133/\$1811.95
.475 Linebaugh	#20833/\$164.95	call
.480 Ruger	#20833/\$164.95	call
.500 S&W Magnum	#20834/\$164.95	#20428/\$1876.95*
Rifle Calibers	Conversion#/Price	Machine#/Price
.223 Remington	#20485/\$127.95	#21130/\$1811.95
.223 Rem./Carbide	call	#21131/\$1893.95*
.22-250	#21055/\$145.95	#21129/\$1811.95
.243 Winchester	#21054/\$145.95	#21126/\$1811.95
6.5 Creedmoor	#62403/\$145.95	#62404/\$1811.95
6.8 SPC	#20468/\$145.95	#21150/\$1861.95*
.270 Winchester	#21053/\$145.95	#18491/\$1811.95
.30 Carbine	#20626/\$145.95	#21142/\$1828.95*
7.62x39	#20631/\$164.95	#21144/\$1861.95*
.300 AAC Blackout	#62374/\$127.95	#62388/\$1903.95*
.30-30 Winchester	#21052/\$145.95	#21003/\$1811.95
.300 WSM	#20466/\$174.95	#21110/\$1876.95*
.303 British	#21051/\$127.95	#21060/\$1811.95
.308 Winchester	#21049/\$145.95	#21058/\$1811.95
.308 Win./Carbide	call	#21068/\$1901.95*
.30-06 Springfield	#21050/\$208.95	#21059/\$1874.95*
.30-06 Sp./Carbide	call	#62178/\$2034.95*
.45-70 Government	#21056/\$178.95	#21064/\$1929.95*

### A(3). 1050 PRIMER SYSTEM<sup>^</sup>

Large primer system conversion O86-20476 \$114.95

Small primer system conversion O86-20419 114.95

### A(4). EXTRA CASEFEED PLATE<sup>^</sup>

Large pistol	O86-21072	\$39.95
Large rifle	O86-21075	39.95
Small rifle	O86-21074	39.95
Small pistol	O86-21073	39.95
1050 POWDER MEASURE <sup>^</sup>	O86-20421	\$89.95
1050 TOOLHEAD <sup>^</sup>	O86-20420	\$202.95

**B. BUSHING DRIVER**  
 O86-20341, \$13.95 ea.

**WARNING:** The products offered for sale in this catalog can expose you to chemicals, including Lead, which are known to the State of California to cause cancer, birth defects or other reproductive harm. For more information, go to [www.P65Warnings.ca.gov](http://www.P65Warnings.ca.gov).

### C. TOOLHEAD STAND

- Black O86-62201, \$49.95  
 Blue O86-62200, \$49.95

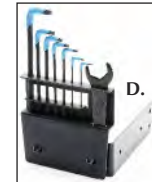
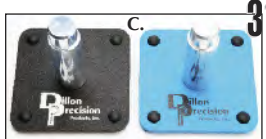

**D. 1050 TOOLHOLDER**  
 Keeps the tools you need handy and organized! Wrenches included.  
 With bracket O86-62202, \$34.95  
 W/O bracket O86-62203, \$30.95  
 Ball End Dipped Wrench Set O86-62161, \$18.95

### E. PRIMER PICKUP TUBES

- Used to transfer primers from flip tray to priming system.
- |              |           |        |
|--------------|-----------|--------|
| 1 Lg.        | O86-22029 | \$7.99 |
| 1 Sm.        | O86-22028 | 7.99   |
| 2 Sm., 2 Lg. | O86-20056 | 25.95  |
| 4 Lg.        | O86-20050 | 25.95  |
| 4 Sm.        | O86-20049 | 25.95  |

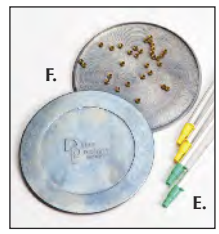

### F. PRIMER FLIP TRAY

A heavy, high-quality tray large enough for the Federal primer package. O86-13606, \$22.95 ea.



**G. MACHINE COVER<sup>^</sup>**  
 This nylon cover adds security to your loading bench. Comes equipped with a D-ring, allowing the heavy-duty zipper to be locked.  
 O86-13239, \$39.95



**H. Master lock,**  
 O86-13083, \$3.95

### I. BULLET TRAY

Designed for "economy of motion" when loading.  
 O86-22215, \$44.95



- J. SPARE PARTS KIT<sup>^</sup>**
- 1 Super 1050 Spring Bushing
  - 1 Cam Guide Bolt 1/4-20
  - 1 Super 1050 Toolhead Spring
  - 1 Priming Station Retaining Tab
  - 1 Ratchet Restriction Tab
  - 4 Lock Ring Inserts
  - 3 Pistol Decapping Pins
  - 2 #10 Tinnerman Inserts
  - 1 1/4" E-Clip

- 3 Bellcrank Cubes
  - 2 Primer Punch Springs
  - 2 1/4-20 3/8 BH Screws
  - 4 Locator Springs (#1, #2, #3, #4)
  - 1 Tab/Priming Arm Spring
  - 2 Pickup Tube Tips, Small, Yellow
  - 2 Magazine Orifices, Large, Red
  - 2 Pickup Tube Tips, Large, Green
  - 2 Magazine Orifices, Small, Blue
  - 2 Retaining Clips
  - 1 Slide Roll Pin Sleeve
  - 2 Dispensing Tips, Small
  - 2 Dispensing Tips, Large
- O86-20779, \$35.95

### K. MACHINE MAINTENANCE KIT<sup>^</sup>



Everything you need to keep your Dillon loader cleaned and lubricated up to factory specifications. Available in combination with a spare parts kit.  
**Maint. Kit & 1050 Spare Parts Kit**  
 O86-97018, \$48.95



# Range Bag<sup>^</sup>



Dillon's Range Bag is designed to hold the Border Shift Ammo Bag (sold separately below), as well as a Dillon Large Utility Box (see Page 64). The Main Compartment is 12.5" long x 7" wide x 10" high, the End

Pockets are 8.5" tall x 6.5" wide x 2" deep and the Front Pocket is 9" tall x 6" wide x 2" deep.  
Range Bag, Black **O86-19366 \$89.95**  
Pistol Pouch, Black<sup>^</sup> **O86-17027 10.95**

# 'Border Shift' Ammo Bag<sup>^</sup>

Dillon's two-compartment ammo bag is constructed with a flexible inner liner that will allow the entire volume to be accessible from either zippered opening. You'll never again mix fired brass with loaded rounds!



**Black Ammo Bag O86-13755 \$25.95**

**I.D. Card Holder  
O86-14575 \$2.95**



## Dillon's Shooting Mat<sup>^</sup>

Dillon's shooting mat is made of tough ballistic-weave nylon fabric, with a large skid-resistant elbow pad area. The "ground" side is moisture resistant and wipes clean easily. The padding is dense, closed-cell foam to provide both shooter comfort and a stable shooting base. The mat is equipped with a shoulder strap, a carry handle and two straps with snap-release buckles. *Dimensions: 66" x 27.75"*  
**O86-18146 \$65.00**

**⚠️ WARNING:** The products offered for sale in this catalog can expose you to chemicals, including DEHP, which are known to the State of California to cause cancer, birth defects or other reproductive harm. For more information, go to [www.P65Warnings.ca.gov](http://www.P65Warnings.ca.gov).

# Mr. Bulletfeeder<sup>®</sup> by Double-Alpha

Mr. Bulletfeeder has been around for some years now, and has gained a huge following worldwide. The patented system is by far the best performing personal-use bullet feeder on the market, and has been, since its introduction in 2006. Double-Alpha Academy has teamed up with RAK Systems, the original designer and patent holder of the system, to redesign and streamline the product, making it more compact, more versatile, better looking and more affordable than ever before.

The Mr. Bulletfeeder by Double-Alpha is now a production-grade product, with Double-Alpha Academy – a world leader in practical-shooting-related product manufacturing and distribution – at the helm. The design allows the bullet collator to be mounted onto the casefeeder, eliminating any increased footprint and space use, and the new patent-pending dropper is a huge step forward in design, durability and reliability.

**Mr. Bulletfeeder (Comes Set Up in One Caliber)**

9mm/.38/.357	<b>O86-15145</b>	<b>\$469.95</b>
.40 S&W/10mm	<b>O86-15146</b>	<b>469.95</b>
.45 ACP	<b>O86-15148</b>	<b>469.95</b>
.223 Rem./5.56 NATO	<b>O86-15150</b>	<b>493.95</b>
.30 cal./7.62mm	<b>O86-15153</b>	<b>499.95</b>
6.5mm	<b>O86-15154</b>	<b>499.95</b>

**Mr. Bulletfeeder Caliber Conversions**

9mm/.38/.357	<b>O86-15168</b>	<b>\$149.95</b>
.40 S&W/10mm	<b>O86-15169</b>	<b>149.95</b>
.45 ACP	<b>O86-15170</b>	<b>149.95</b>
.223 Rem./5.56 NATO	<b>O86-15171</b>	<b>169.95</b>
.30 cal./7.62mm	<b>O86-15172</b>	<b>182.95</b>
6.5mm	<b>O86-15173</b>	<b>182.95</b>

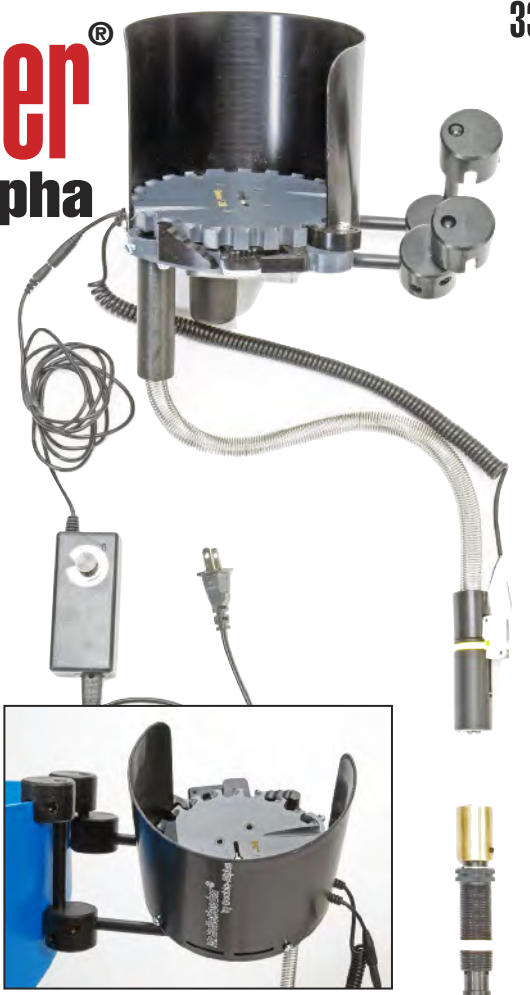

## Mr. Bulletfeeder<sup>®</sup> Replacement Parts & Spares



Having separate Bullet Dropper Dies allows you to quickly swap toolheads of the same caliber sizes without having to remove and readjust the bullet dropper die.



The Output Tube Assembly is what connects the Mr. Bulletfeeder by DAA's collator to the dropper. It feeds the bullets into the dropper, keeping them aligned and feeding smoothly. The Small Output Tube Assembly is required for the rifle calibers (both .223 and .308) as well as when loading very short, light 9mm bullets, such as many of the 90-grain bullets available. The Large Output Tube Assembly is required when loading 9mm (over 115-grain bullets), .40, or 45.



Use a spacer? This four-pack of Nose Guide Spacers is identical to what comes with the Mr. Bulletfeeder. These are used to adjust the height of bullets, so they don't spill out or flip upside-down.

<b>Mr. Bulletfeeder Replacement Bullet Dropper Dies</b>		<b>Mr. Bulletfeeder Replacement Output Tube Assemblies</b>	
9mm/.38/.357	<b>O86-10218</b>	\$94.95	Small Output <b>O86-10238</b> <b>\$34.95</b>
.40 S&W/10mm	<b>O86-10219</b>	<b>94.95</b>	Large Output <b>O86-10239</b> <b>34.95</b>
.45 ACP	<b>O86-10220</b>	<b>94.95</b>	<b>Mr. Bulletfeeder Replacement Nose Guide Spacers</b>
.223 Rem./5.56 NATO	<b>O86-10221</b>	<b>94.95</b>	Set of Four <b>O86-10237</b> <b>\$2.95</b>
.30 cal./7.62mm	<b>O86-10236</b>	<b>94.95</b>	

**⚠️ WARNING:** The products offered for sale in this catalog can expose you to chemicals, including Lead, which are known to the State of California to cause cancer, birth defects or other reproductive harm. For more information, go to [www.P65Warnings.ca.gov](http://www.P65Warnings.ca.gov).

# Dillon's Rifle Die Sets

## Size Die

- Full-length, to minimum tolerance
- Carbide expander ball
- Features stuck case remover

## Seat Die

- Designed to hold bullet straight throughout the seating process

## Taper Crimp Die

- Centers case neck and body for a more uniform crimp

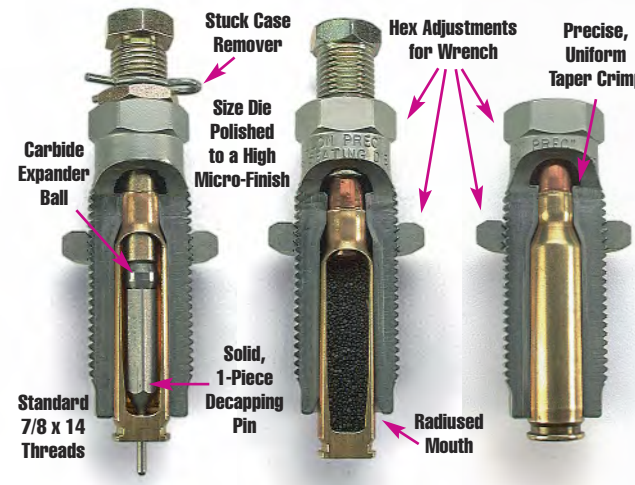

Dillon Three-Die Rifle Die Sets include a sizing/depriming die, a bullet seating die and a taper crimp die. Dillon Two-Die Rifle Die Sets include a sizing/depriming die and a seat/crimp die.

### Sizing/Depriming Die

The sizing/depriming die is full-length, to minimum tolerances, sizing cases down to function in semi- and full-automatic firearms. We strongly suggest that a head-space case gage be used to correctly adjust the size die.

For high volume users, such as commercial reloaders, law enforcement agencies, and high power or service rifle competitors, we also offer .223 and .308 die sets with a full-length carbide sizing die. Lubrication is still required, but the increased scratch resistance and die longevity of carbide are of great benefit to these groups of users.

The depriming assembly includes a carbide expander ball for "squeak-free," effortless neck expansion. This expander ball is located in the middle of the depriming stem to take advantage of superior initial leverage for easier extraction.

In the event of a stuck case, the design of the depriming assembly allows it to function as a stuck case remover.

### Bullet Seating Die

Our bullet seating die is internally designed to keep the bullet straight throughout the seating process. Once properly adjusted, the only measurable runout will be that which is inherent in the bullet.

### Taper Crimp Die

The taper crimp die is also specially configured to center both the case neck and the case body, thereby aligning the entire cartridge for a more uniform crimp. Dillon Rifle Dies are designed to meet the more rigid requirements for both accuracy and precision demanded by today's marksman.

A taper crimp die is preferred for loading ammunition intended to be used in semiautomatic firearms with detachable box magazines, and in lever-action firearms with tubular magazines.

**WARNING:** The products offered for sale in this catalog can expose you to chemicals, including Lead, which are known to the State of California to cause cancer, birth defects or other reproductive harm. For more information, go to [www.P65Warnings.ca.gov](http://www.P65Warnings.ca.gov).

# Dillon's Pistol Die Sets

## Size Die

- Floating Decap Assembly Eliminates Primer "Draw Back"
- Long, Tapered Carbide Ring
- Radiused Opening Makes Progressive Loading Smoother

## Seat Die

- Reversible Seating Stem Makes it Easy to Change Bullet Styles

## Crimp Die

- Quick Disassembly, Easy to Clean



**Dillon Pistol Dies (Three-Die Sets) ^**

.32 S&W Long/.32 H&R Mag.	O86-14426	\$69.95
.380 ACP	O86-14401	69.95
9mm Parabellum	O86-14406	69.95
9x25 Dillon	O86-14601	150.95
.357 SIG	O86-22083	150.95
.38 Super	O86-14399	69.95
.38 Special/.357 Magnum	O86-14400	69.95
10mm/.40 S&W	O86-14398	69.95
.41 Magnum	O86-14402	69.95
.44 Special/.44 Magnum	O86-14403	69.95
.45 ACP/.45 GAP	O86-14404	69.95
.45 Colt	O86-14405	69.95

**Dillon Carbide Size/Deprime Dies ^**

.32 S&W Long/.32 H&R Mag.	O86-14119	\$36.30
.380 ACP	O86-14410	30.30
9mm Parabellum	O86-14415	30.30
9x25 Dillon	O86-14602	116.30
.357 SIG	O86-16513	116.30
.38 Super	O86-14408	30.30
.38 Special/.357 Magnum	O86-14409	30.30
10mm/.40 S&W	O86-14407	30.30
.41 Magnum	O86-14411	30.30
.44 Special/.44 Magnum	O86-14412	30.30
.45 ACP/.45 GAP	O86-14413	30.30
.45 Colt	O86-14414	30.30

**Spare Decapping Pins**

Package of 10	O86-21528	\$6.75
---------------	-----------	--------

**Spare 1/4" E-Clips for the Pistol Decapping Assembly**

Package of 10	O86-62408	\$4.95
---------------	-----------	--------

**Dillon Seating Dies ^**

.32 S&W Long/.32 H&R Mag.	O86-14106	\$26.30
.380 ACP	O86-14419	26.30
9mm Parabellum	O86-14424	26.30
9x25 Dillon	O86-14603	29.30
.357 SIG	O86-16515	29.30
.38 Super	O86-14417	26.30
.38 Special/.357 Magnum	O86-14418	26.30
10mm/.40 S&W	O86-14416	26.30
.41 Magnum	O86-14420	26.30
.44 Special/.44 Magnum	O86-14421	26.30
.45 ACP/.45 GAP	O86-14422	26.30
.45 Colt	O86-14423	26.30

**Dillon Crimp Dies ^**

.32 S&W Long/.32 H&R Mag.	O86-14107	\$25.30
.380 ACP	O86-14438	25.30
9mm Parabellum	O86-14443	25.30
9x25 Dillon	O86-14604	28.30
.357 SIG	O86-16514	28.30
.38 Super	O86-14436	25.30
.38 Special/.357 Magnum	O86-14437	25.30
10mm/.40 S&W	O86-14435	25.30
.41 Magnum	O86-14439	25.30
.44 Special/.44 Magnum	O86-14440	25.30
.45 ACP/.45 GAP	O86-14441	25.30
.45 Colt	O86-14442	25.30

**Sizing/Depriming Die**  
Our sizing/depriming dies feature a unique "floating decap assembly" with a snap spring that throws the spent primer off the pin and eliminates the problem of primer "draw back" that often occurs when decapping military brass. The primary feature of Dillon's size die design – the long, tapered carbide ring with a radiused opening – remains unchanged.

That radiused opening, and its importance to progressive reloading, is one of the reasons why our seat and crimp dies are better. We found a way of manufacturing these dies that has enabled us to make the lead-in radius even bigger! The bigger radius makes progressive loading with our equipment even smoother – but that's still only a part of the story.

**Bullet Seating Die**  
Our quick-disassembly seat die allows the user to disassemble and clean the seat die without losing adjustment. In this manner, bullet lube and shavings can be quickly removed from the die, thereby guaranteeing a constant seating depth. We've incorporated a "flip-flop" seating stem and a clip that enables you to remove the die insert and change the seating stem from round nose to semi-wadcutter without unscrewing a seating stem out of the die body. We've always included both types of seating stems, but the new double-ended design makes it a simple matter to remove a pin, reverse the seating stem, make any minor seating depth adjustments that may be necessary and go on loading in a fraction of the time it used to take.

**Crimp Die**  
We've made it easy for you to remove the die insert for cleaning without having to change the critical crimp adjustment. Once your crimp die is set for the proper amount of crimp, you'll never have to change it. This is especially good news for all of you who load lead bullets! Before, you had to unscrew the die from the tool-head and disassemble the die in order to remove any bullet lube or lead residue. Then, you had to start from square one to re-adjust the crimp. Those days are over. All you have to do now is pop a clip and the die insert drops into your hand for cleaning.

**NOTE:** All Dillon Pistol Die sets include our sizer/decap die, seat die and a separate crimp die. (Taper crimp for autos; accu-crimp for revolvers.)



# American Rimfire .22 WMR Compact Rifle

### By John Marshall

For many years, I've been a fan of the .22 Winchester Magnum Rimfire cartridge. It's been around since 1959; designed to one-up the ubiquitous .22 Long Rifle round in both power and range. This makes it suitable for small game, varmints, plinking and target shooting out to more than 100 yards. In fact, a 40-grain bullet from the WMR has more kinetic energy at 100 yards than the .22 LR has at the muzzle. It shoots farther, flatter and more powerfully at all ranges. Adjusting a rifle for maximum point blank range with a 3-inch target, the WMR has an effective range of nearly 125 yards, maintaining a center hold. A warning: The case is longer and wider than the .22 LR. Therefore, .22 LR ammo is quite dangerous to fire in a WMR chamber, with case splits and release of high-pressure propellant gas into the action being quite probable. Don't even think about it.

Over my lifetime, I have acquired a number of firearms chambered for this great round, including a Smith & Wesson Model 48 double action revolver, an old model Ruger Super Single Six single-action revolver, and a Winchester 94/22 lever-action rifle. I never scoped that 94/22, although I could have. In keeping with its "old west" profile, I preferred to retain that nostalgic look by leaving it unadorned with a scope. Accordingly, I hunted for a handy, lightweight, reliable and accurate bolt-action .22 WMR rifle that I could scope for maximum effect. I had once test-fired a no-name foreign-made rifle that would not feed reliably due to shoddy workmanship, and I realized that I really needed good old American craftsmanship to bring everything together into an ideal combination of desirable features.

Eureka! At a recent gun show, a local firearms dealer was selling brand-new Ruger American rifles, and among them was a compact .22 WMR piece. Upon examination, it really impressed me

with its features and its out-the-door price, which amounted to a shade over \$300. Bingo. I took it home.

Here are the things that impressed me about the rifle, which weighs a scant 5.38 pounds, measures 35.5" overall, and is equipped with an 18" hammer-forged barrel. Immediately noticeable was the detachable rotary flush-mounted magazine, the same JMX-1 used in the old 10/22 Magnum semiauto and subsequently in the now-discontinued 77/22 bolt action. It has a capacity of 9 rounds and is known for absolute reliability in feeding. It's drop-detached by a paddle release in the stock. Reading the instructions, I noted that the trigger is easily adjustable from 3 to 5 pounds. When the stock is removed from the barreled action (two hex-head screws are removed), it exposes the trigger group. The hex-head trigger weight adjustment screw is located at the front end of this assembly, and has about 6 full turns of latitude. I adjusted mine for a letoff of 3.5 pounds as measured on my RCBS trigger scale.

The "Ruger Marksman" trigger has a release lever imbedded in it that prevents and blocks movement of the sear until it is fully depressed into the trigger prior to letoff. It works easily, and the subsequent trigger pull is crisp with minimal overtravel. Hence, you have an action that is very safe against discharge unless the trigger is fully and deliberately depressed. The sliding safety switch is integral with the trigger group and is mounted centrally behind the receiver for easy access by either right or left handers. It works smoothly and positively, having just two positions, forward for fire and back for safe. Manipulation of the bolt in loading or unloading is possible while the switch is in the "safe" position. The trigger group has a handy port for lubrication of the assembly when needed. Just above the trigger group in the left side of the receiver is a separate

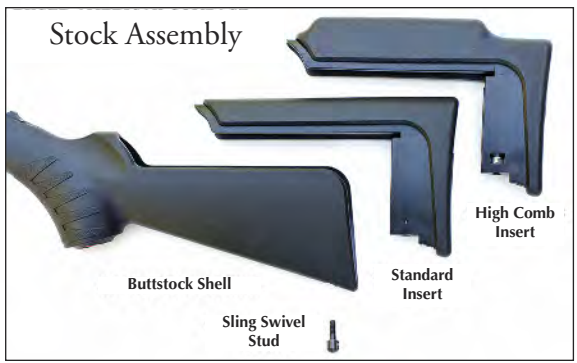
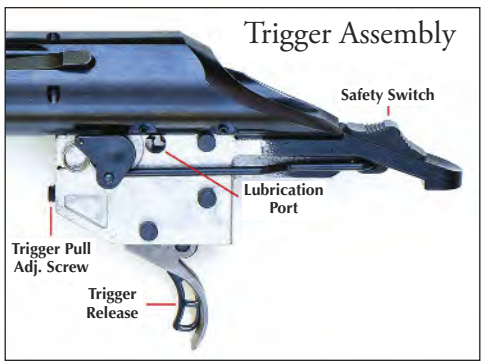

bolt release, allowing easy removal of the bolt without having to squeeze the trigger (which doubles as a bolt release in many other designs). This is a definite good safety feature.

The bolt used on the Ruger American Rimfire series is rather straightforward, with a substantial bolt handle root precisely engaging a cutout section in the receiver to provide secure lockup. The bolt lift is only 60 degrees to give lots of clearance for a scope, and cocks on opening. There is a hook at the front of the bolt on a circular flat spring. This holds the cartridge case in position and doubles to spring-load the extractor on the other side. There is a fixed ejector in the receiver.

While I had the stock removed from the action, I noted the precise "Power Bedding" system. The stock incorporates a steel bedding block that accurately mates with two angled steel lugs on the bottom of the receiver. This is "steel on steel" exactness – no possibility of change in the bedding. When the barreled action is cinched down into the stock with its two screws tightened alternately for evenness, the receiver is securely mated to the stock. The barrel itself, press-fit and pinned into the receiver, is full-length free-floated for maximum accuracy. It also is target-crowned and equipped with a U-cut fully adjustable folding rear sight and a green Williams fiber-optic front sight. It's very noticeably visible when the open sights are used. If you are thinking about eventually applying a sound suppressor or flash attenuator to this rifle, Ruger is way ahead of you. The muzzle on this model is already threaded for these purposes. A muzzle cap is provided to protect the threads when nothing is attached.

Do you prefer tip-off scope grooves or Weaver bases to mount your scope? Well, Ruger has you covered there. The receiver is both grooved **and** drilled and tapped to accommodate Weaver number 12 scope bases! You decide which system meets your needs. As for me, I chose some high tip-off mounts to clear the rear sight, and installed a suitable 3-9X scope. The higher mounts also give a bit longer point-blank range, with the line of sight and bullet trajectory meeting farther away down range.

Some folks like to use the open iron sights, while others will opt to mount a scope. The only problem is that just one stock comb height will not be suitable for both approaches. Ruger thought this one through, and provided a black synthetic composition stock that will take interchangeable stock inserts, one having a higher comb than the other for scope use. Both inserts are provided with the rifle. If you prefer a longer length of pull than the factory 12.5", longer inserts are available from Ruger for about \$20. All of these inserts can be easily switched out by the simple expedient of unscrewing the rear quick-detachable sling swivel stud. It anchors any insert solidly in the stock. The insert already in the stock can then be tapped out with a wooden dowel and a small hammer, allowing a different one to be slapped in and secured with the re-insertion and tightening of the sling swivel stud.

The stock on this rifle, by the way, is well textured in the gripping areas, and rain and/or sweat should not play any role in one's ability to maintain a firm grip on it. I also appreciate that stan-

# Dillon's SL 900<sup>^</sup>

## Shotshell Loader

### STANDARD FEATURES:

- Automatic Indexing
- Auto Powder/Priming Systems
- Adjustable Case-Activated Shot System
- Factory Adjusted to Load AA Hulls
- Factory Adjusted Loading Dies
- The Original Tilt-Out Wad Guide
- Lifetime "No-B.S." Warranty
- **RISK FREE 30-Day Trial Period!**

All for ONLY...  
**\$1039<sup>95</sup>**

*\$1289.90 with Casefeeder*

12 Gauge 086-97110 20 Gauge 086-97123  
 28 Gauge 086-97124 Comes with factory adjusted dies



Total price as pictured here with optional accessories: **\$1332.85**

12 Gauge Casefeeder (pictured)	086-97037	\$249.95
20/28 Gauge Casefeeder	086-97036	\$249.95
12 Ga. Euro. 220v Casefeeder	086-97118	\$259.95
20/28 Ga. Euro. 220v Casefeeder	086-97125	\$259.95
Low Powder Sensor	086-16306	\$42.95

### A. SL 900 CONVERSIONS<sup>^</sup>

- 12 Gauge Conversion  
086-20009, \$374.95
- 12 Gauge Casefeed Plate (not pictured)  
086-17811, \$43.95
- 20 Gauge Conversion  
086-22138, \$374.95
- 28 Gauge Conversion  
086-22139, \$374.95
- 20/28 Gauge Casefeed Plate (not pictured)  
086-97045, \$43.95
- SL 900 Powder System  
086-17817, \$83.95



### B. SL 900 MACHINE COVER<sup>^</sup>

This heavy-duty nylon cover comes equipped with a D-ring, allowing the zipper to be locked.



- 086-13239, \$39.95
- (C.) Master lock  
086-13083, \$3.95



### D. PACKAGE DEAL<sup>^</sup>

Includes: Lyman Reloading Handbook, Clear Safety Glasses, Dial Caliper, Eliminator Scale, Machine Cover, and Low Powder Sensor.  
**086-22290, \$199.95**

### E. SPARE PARTS KIT<sup>^</sup>

- 1 20 Gauge Yellow Wad Guide
  - 1 28 Gauge Green Wad Guide
  - 1 20 Gauge Locator Pin
  - 1 Index Pawl
  - 1 Ring Indexer
  - 1 Index Spring Revision A
  - 1 Hair Pin Cotter
  - 2 Bellcrank Cubes
  - 1 Case Insert Slide Spring
  - 1 Pawl Spring
  - 1 Ejector Wire
  - 1 Plastic Wad Guide
  - 1 Swing Arm Torsion Spring
  - 1 Primer Transfer Arm
  - 1 12 Gauge Locator Pin
  - 1 Gum Rubber Insert Revision B
  - 1 Shot Fitting E-Clip
  - 1 Failsafe Bushing Revision B
- 086-11154, \$27.95**

<sup>^</sup> **WARNING:** The products offered for sale in this catalog can expose you to chemicals, including Lead, which are known to the State of California to cause cancer, birth defects or other reproductive harm. For more information, go to [www.P65Warnings.ca.gov](http://www.P65Warnings.ca.gov).

standard quick-detachable sling swivel studs are provided on this rifle. In the past, Ruger had used some rather cheesy 1" stirrup-style sling mounts on some of its rimfire rifles.

After examining and prepping the rifle to suit my preferences, a trip to the range was next in order. I had on hand some CCI .22 WMR "Maxi Mag" Gold Dot HP (40-grain hollow point jacketed bullet at a listed 1875 feet per second) ammo and packed it with the rifle to a nearby indoor rifle and handgun range. This range allows for only a maximum distance of 25 yards for shooting, but I figured it would give me a good indication of the rifle's accuracy potential. I set up some bullseye targets at 25 yards, and went to work. A bench rest was not available, so I improvised by resting the rifle in the nest of my Dillon range bag. A few twists of the elevation and windage knobs on the scope brought the point of impact to the center of a bull. Now my eyes are getting old, no longer giving me the unaided eagle eyes of my youth, and the improvised rest for the rifle did not prevent some user-induced wobble. Still, the results were quite good. A final 3-shot group measured 1/2 inch in the X-ring of the target. I had no doubt that a benchrest setup would probably halve the group, and others have reported

1/2 inch groups at a longer 50 yards. That equates to one minute of angle, the traditional standard for rifle accuracy.

Daniel Boone once bragged that his rifle could flick a flea off a dog's posterior if he did his part, and I have no doubt that this rifle is in the same "flea flicker" league. Like most rimfire rifles, accuracy is partly determined by the specific ammunition used, so I suspect that even better groups could be secured with some experimenting with different ammo. I would hate to be a ground hog within 100 yards of this rifle once that "sweet spot" combo of load and rifle was suitably matched.

I decided to order an extra magazine for quick reloads in the field. The internet makes such things quite easy to do, as this is a standard Ruger product and is readily available.

It's quite evident to me that the folks at Ruger put a lot of thought and effort into nearly all aspects of this rifle. While I would have preferred a soft rubber buttplate for stability, I do understand that putting one on each of the stock inserts would unnecessarily increase the costs of manufacture. At the current reasonable retail price of this rifle, I think it's a bargain. It gets my enthusiastic stamp of approval!

*We're Glad to See*

*You're Back!!*

**SUPER VEL<sup>®</sup>**  
*Ammunition*

[www.SuperVelAmmunition.com](http://www.SuperVelAmmunition.com)

© Copyright 2017, Super Vel. All Rights Reserved

# 40 SAFARILAND Equipment Locking System

## ELS Quick Attachment Accessory System



Sorry, but the shotshells and magazine pictured do not come with these ELS System components.

**4-Shell Holder with ELS Attaching Fork (You'll need a Receiver Plate.)**  
 4 Shell Holder O86-15181 \$58.00

**8-Shell Holder with ELS Attaching Fork (You'll need a Receiver Plate.)**  
 8 Shell Holder O86-15182 \$108.00

**Mag Pouches (You'll need an Attaching Fork & Receiver Plate or other hardware.)**  
 AR Mag Pouch O86-19396 \$19.95  
 M1A Mag Pouch O86-19397 19.95



2 ELS Attaching Forks O86-16685 \$20.00

2 ELS Receiver Plates O86-16686 \$20.00

2 Forks/2 Plates O86-15184 \$35.00

## GRSC Sling Mounts



A. CAR-15 Ambidextrous CQB Sling Mount with slots O86-18968 \$14.95  
 CAR-15 Ambidextrous CQB Sling Mount without slots (not pictured) O86-19170 \$14.95  
 B. A2-Style AR-15 CQB Right-Hand-Only Sling Mount O86-19168 \$34.95  
 C. Remington 870 Shotgun Ambidextrous CQB Sling Mount O86-19169 \$24.95



**\$23.95**  
**O86-19214**

Reduced recoil, 1200 fps 25 per box.  
 NOTE: Age verification required to order.

# CCW Tactical Shotshell Strippers<sup>41</sup>



California Competition Works' Tandem Tactical Strippers can be used to hold either shotshells or AR-15/M4/Mini 14 magazines, or a combination of both by installing or removing the aluminum spacers provided with each stripper. The Tandem Tactical Stripper holds a maximum of eight rounds of 12 Gauge (10 rounds of 20 Gauge) shotshells or two AR-15/M4/Mini 14 magazines. Each Tandem Tactical Stripper features a BLADETECH Tek-Lok™ Universal Belt Clip, four removable aluminum spacers, and the screws and Allen wrench required to install them.

O86-00303 \$55.00

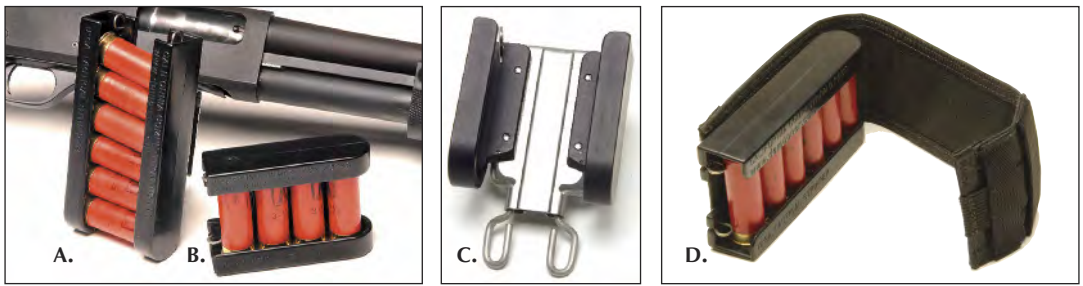

California Competition Works' Tactical Strippers are available in three, four or six-shell versions that allow quick access to your shotgun reloads. Engineered to carry up to 3" magnum\* shells as well as the longer European shotshells. All CCW Tactical Strippers are equipped with either a belt clip (A. & B.) or a UM84 attachment device (C. & D.) that will accommodate up to a 2-1/4" duty belt.

A. Six-Shell Tactical Stripper O86-18606 \$23.95  
 B. Four-Shell Tactical Stripper O86-18605 22.95  
 C. Three-Shell Aluminum Stripper\* O86-19475 34.95  
 D. Six-Shell Covered Tactical Stripper O86-19225 33.95

\*Three-Shell Aluminum Stripper accommodates 2-3/4" shells only.

## Ed Brown Products 1911 Parts

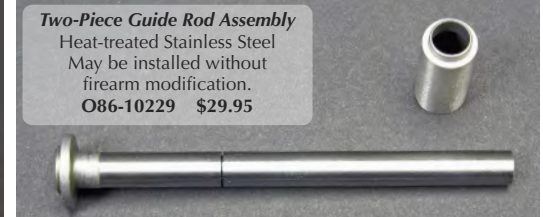

**Two-Piece Guide Rod Assembly**  
 Heat-treated Stainless Steel  
 May be installed without firearm modification.  
 O86-10229 \$29.95



**Rebuild Kit**  
 for 1911-Style Pistols,  
 STAINLESS (pictured)  
 O86-10226 \$19.95  
 BLUE  
 O86-10225 \$19.95



**Grip Screw Bushings**  
 Set of Four for  
 1911-Style Pistols  
 STAINLESS (pictured)  
 O86-10228 \$7.95  
 Set of Four for  
 1911-Style Pistols  
 BLUE  
 O86-10227 \$6.95



The new Super Vel.  
 Hotter.  
 Faster.  
 Better.

The original Super Vel Cartridge Company forever changed "police ammunition" with a new style of bullet, the jacketed hollow point. Now, 40 years later, Super Vel is back!

Advertised velocity figures from Super Vel's website are as follows: .380 ACP 80 Gr. Solid Copper Hollow Point 1,100 fps (Walther PP); 9mm 90 Gr. JHP 1,473 fps (GLOCK 43) to 1,632 fps (GLOCK 17L); .38 Special 90 Gr. JHP 1,318 fps (S&W Model 642) to 1,652 fps (S&W Model 27); and .45 ACP 185 Gr. JHP 1,085 fps (S&W M&P) to 1,127 fps (Springfield 1911).

.380 ACP "Pocket Rocket" 80 Gr. SCHP (20) O86-10270 \$24.95  
 9mm +P 90 Gr. JHP (50) O86-10023 39.95  
 .38 Special +P "Super Snub" 90 Gr. JHP (20) O86-10024 22.95  
 .45 ACP +P 185 Gr. JHP (50) O86-10031 53.95

**WARNING:** The products offered for sale in this catalog can expose you to chemicals, including Lead, which are known to the State of California to cause cancer, birth defects or other reproductive harm. For more information, go to [www.P65Warnings.ca.gov](http://www.P65Warnings.ca.gov).

# 42 Berry's Manufacturing Preferred Plated Bullets<sup>^</sup>

Description	Stock #	250	500	1000	158 gr. FP-DS*	O86-17539	33.00	64.00	118.00
<b>Bullets for the 7.62 x 39 Cartridge</b>									
123 gr. RN-DS*	O86-17210	\$42.00	\$81.00	\$150.00					
<b>.380 Caliber Bullets</b>									
100 gr. RN-DS*	O86-17532	24.00	46.00	85.00					
<b>9 Millimeter Bullets</b>									
115 gr. RN-DS*	O86-17533	25.00	49.00	90.00					
115 gr. HBRN-TP*	O86-17178	27.00	52.00	96.00					
124 gr. RN-DS*	O86-17534	27.00	51.00	95.00					
124 gr. HBRN-TP*	O86-17272	30.00	57.00	106.00					
124 gr. HBFP-TP*	O86-17385	30.00	57.00	106.00					
147 gr. RN-DS*	O86-17535	31.00	60.00	110.00					
<b>.357 Caliber Bullets</b>									
125 gr. FP-DS*	O86-17536	28.00	53.00	98.00					
158 gr. RN-DS*	O86-17540	33.00	63.00	117.00					

\*DS = Double Struck, TP = Thick Plate, HB = Hollow Base, RN = Round Nose, FP = Flat Point, SWC = Semi Wadcutter, WC = Wadcutter

# SNS Casting Hard-Cast Lead Bullets<sup>^43</sup>

Hard-Cast Lead Bullets	Stock #	500	1000	9mm No Lube Groove 125 gr.	O86-15756	42.00	78.00
9mm RN 125 gr.	O86-15258	\$40.00	\$74.00	9mm RN 135 gr.	O86-15043	44.00	81.00
9mm FP 125 gr.	O86-15279	40.00	74.00	9mm RN 147 gr.	O86-15044	47.00	88.00
9mm RNFP 147 gr.	O86-15259	43.00	80.00	9mm FP 147 gr.	O86-15333	47.00	88.00
.38/.357 RN 125 gr.	O86-15261	40.00	74.00	9mm/.38 Super RN 160 gr.	O86-15397	52.00	97.00
.38/.357 RNFP 125 gr.	O86-15307	40.00	74.00	.38/.357 RNFP 100 gr.	O86-15859	41.00	76.00
.38/.357 SWC 158 gr.	O86-15263	43.50	81.00	.38/.357 FP 105 gr.	O86-15860	42.00	77.00
.38/.357 RN 158 gr.	O86-15292	43.50	81.00	.38/.357 FP 125 gr.	O86-15879	42.00	79.00
.38/.357 RNFP 158 gr.	O86-15264	43.50	81.00	.38/.357 RNFP 130 gr.	O86-19679	44.00	81.00
.40/10mm FP 140 gr.	O86-15265	42.00	78.00	.38/.357 DEWC 148 gr.	O86-15880	47.00	88.00
.40/10mm SWC 175 gr.	O86-15266	50.00	92.00	.38/.357 RN 158 gr.	O86-15045	52.00	97.00
.40/10mm FP 180 gr.	O86-15267	50.50	94.00	.38/.357 SWC 158 gr.	O86-15881	52.00	97.00
.40/10mm RN 200 gr.	O86-15285	49.00	91.00	.38/.357 RN 160 gr.	O86-15400	52.00	97.00
.44 RNFP 180 gr.	O86-15283	50.50	94.00	.40/10mm FP 140 gr.	O86-15335	47.00	87.00
.44 RNFP 200 gr.	O86-15274	53.00	98.00	.40/10mm RNFP 165 gr.	O86-19677	55.00	101.00
.44 RNFP 240 gr.	O86-15275	60.00	110.00	.40/10mm SWC 175 gr.	O86-15336	57.00	106.00
.44 SWC 240 gr.	O86-15276	60.00	110.00	.40/10mm FP 180 gr.	O86-15337	58.00	107.00
.45 SWC 200 gr.	O86-15270	53.00	98.00	.40/10mm RN 180 gr.	O86-10029	58.00	107.00
.45 RN 230 gr.	O86-15271	57.00	106.00	.40/10mm RN 200 gr.	O86-15338	60.00	112.00
.45 Colt RNFP 180 gr.	O86-15295	51.00	94.00	.40/10mm FP 220 gr.	O86-15855	66.00	123.00
.45 Colt RNFP 200 gr.	O86-15272	53.00	98.00	.44 RNFP 200 gr.	O86-15882	60.00	112.00
.45 Colt RNFP 250 gr.	O86-15273	63.00	118.00	.44 SWC 240 gr.	O86-15891	69.00	129.00
				.45 SWC 185 gr.	O86-15856	58.00	108.00
				.45 RN 200 gr.	O86-15339	60.00	112.00
				.45 RNFP 200 gr.	O86-15857	60.00	112.00
				.45 SWC 200 gr.	O86-15340	60.00	112.00
				.45 RN 230 gr.	O86-15401	66.00	124.00
				.45 RN No Lube Groove 230 gr.	O86-19678	66.00	124.00
				Stock # 250 500			
				.30/30 RNFP 158 gr.	O86-15854	\$27.00	\$50.00

# Sierra Bullets<sup>^</sup>

(This is not LOADED ammunition.)

**5.56mm/.224 Caliber**

52 gr. HPBT MatchKing	100/box	O86-10178	\$25.95
55 gr. BlitzKing	100/box	O86-14458	28.95
69 gr. TMK	100/box	O86-80015	29.95
69 gr. HPBT MatchKing	100/box	O86-13007	27.95
77 gr. TMK	100/box	O86-80016	35.99
77 gr. HPBT MatchKing	500/box	O86-18171	157.95

**6mm/.243 Caliber**

70 gr. HPBT MatchKing	100/box	O86-12386	30.95
-----------------------	---------	-----------	-------

**6.5mm**

123 gr. HPBT	100/box	O86-14459	44.95
142 gr. HPBT	100/box	O86-14460	46.95

**7.62mm/.308 Caliber**

125 gr. HP	100/box	O86-14448	39.95
155 gr. TMK	100/box	O86-80018	48.00
155 gr. HPBT Palma	100/box	O86-18160	39.95
168 gr. TMK	100/box	O86-80017	47.00
168 gr. HPBT MatchKing	100/box	O86-10177	42.95
175 gr. HPBT MatchKing	100/box	O86-17481	44.95



Unprimed brass sold in packages of 100 (This is not LOADED ammunition.)

Description	Stock #	1 Pkg.	5 Pkg.	10 Pkg.
.32 H&R Mag.	O86-30258	\$19.00	\$88.00	\$168.00
.32-20 Win.	O86-31282	25.00	116.00	224.00
9mm	O86-31277	17.00	79.00	152.00
.38 Short Colt	O86-39919	20.00	91.00	175.00
.38 Special	O86-31278	18.00	80.00	154.00
.38 Super +P	O86-31276	20.00	90.00	173.00
.38 Super Comp	O86-30257	20.00	90.00	173.00
.357 SIG	O86-30528	22.00	102.00	196.00
.40 S&W	O86-31283	20.00	93.00	180.00
10mm	O86-31281	21.00	98.00	188.00
.44 Special	O86-31280	24.00	111.00	214.00
.45 ACP	O86-31284	22.00	99.00	190.00
.45 Colt	O86-30259	24.00	111.00	214.00
.500 S&W Mag.	O86-38596	61.00	281.00	542.00

# Once-Fired Brass<sup>^</sup>

Note: Availability Varies, Please Call First

9mm cases	1000/box	O86-43295	\$36.95
.40 S&W cases	1000/box	O86-43297	69.95
.45 ACP cases	1000/box	O86-43298	84.95
.223/5.56mm cases	1000/box	O86-43302	99.95

# Armstrong Projectiles<sup>^</sup>

.38/.357 125 gr. RN	100/pkg.	O86-15823	\$10.50
.38/.357 158 gr. RN	100/pkg.	O86-15819	11.50
9mm 124 gr. FMJ	100/pkg.	O86-15822	11.99
.45 Cal. 230 gr. FMJ	100/pkg.	O86-15814	13.50

# Prvi Partisan Projectiles<sup>^</sup>

.40 Cal. 180 gr. JHP	100/pkg.	O86-15812	\$17.99
.45 Cal. 230 gr. FMJ	100/pkg.	O86-15813	19.99

# Special Purchase Hornady Projectiles<sup>^</sup>

.30 Cal. 147 gr. FMJ	100/pkg.	O86-44445	\$18.62
.38 Cal. 148 gr. HBWC (lead)	250/pkg.	O86-70011	31.79

**Special Purchase .223 FMJ Projectiles<sup>^</sup>**

55 Grain, 1000/pkg  
O86-44444 \$79.95

WARNING: These products contain lead, which is known to cause birth defects, other reproductive harm and cancer. Handling components, ammunition, cleaning firearms or discharging firearms in poorly ventilated areas may result in lead exposure. Have adequate ventilation at all times and wash your hands thoroughly after exposure.

# RCBS Trim Pro 2 Case Trimmer<sup>^</sup>

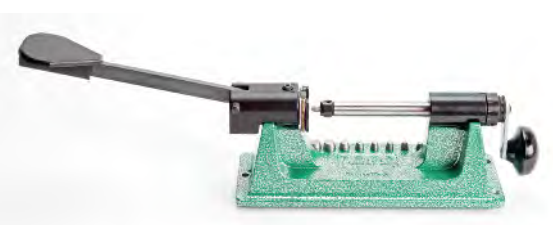

**RCBS Trim Pro-2™ Case Trimmer O86-43231 \$139.95**  
The RCBS Trim Pro-2 manual case trimmer now features a spring-loaded "universal" shell holder that will accommodate case head diameters from .250" to .625". Comes with pilot calibers: .22, .24, .25, .27, .28, .30, .35, .44 and .45.

# Lyman Scale Weight Check Set



Lyman Scale Weight Check Sets enable you to check/calibrate your scale using known weights.  
A. Weight Set .5 - 60.5 Gr. O86-15958 \$36.95  
B. Weight Set .5 - 210.5 Gr. O86-15959 48.95

# Ammo-Burr Cartridge Deburring Sets

SHAVIV is – and has been – the leader in precision hand-deburring solutions since 1960, and now brings its experience to the ammo-reloading market.  
The Ammo-Burr Inner/Outer Cartridge Deburring Sets feature ergonomic comfort-grip handles for fast and accurate hand deburring. The .47" diameter inner chamfering and deburring blade allows for chamfering and deburring cases from .17 to .45 caliber, and the outer-diameter chamfering blade will accommodate case mouth openings as large as 1.02".  
A. Inner Chamfering Starter Set O86-62270 \$39.95  
B. Outer Chamfering Starter Set O86-62269 \$59.95



WARNING: The products offered for sale in this catalog can expose you to chemicals, including Lead, which are known to the State of California to cause cancer, birth defects or other reproductive harm. For more information, go to [www.P65Warnings.ca.gov](http://www.P65Warnings.ca.gov).



# TAYLOR'S & COMPANY HALF-PINT SHARPS .44-40 WINCHESTER

By Oleg Volk

The Sharps falling block action dates back to around 1850. Like most of its percussion contemporaries, it used combustible paper cartridges. Unlike most of them, it loaded from the breech for greater rate of fire, also giving its user the ability to load while prone or on horseback. Compared to its most obvious competitor, the Dreyse bolt action, the Sharps provided considerably better obturation in a more compact action. On the down side, it was still a percussion rifle with caps handled separately from the cartridge carrying spherically conical ball and powder. The massive strength of the falling block allowed very powerful loads exceeding 120 grains of black powder, and excellent accuracy made the Sharps not only a worthy competitor to the muzzle loading Whitworth for sniping purposes, but eventually a popular big game getter. With power, accuracy and range combining neatly in one design, quite a few Sharps rifles were bought or later retrofitted with vernier tang peep sights. In the age of 200-yard military rifles, sharpshooters fielding Sharps rifles were a danger to individual soldiers out to 500 yards, and to buffalo even farther out.

As centerfire metallic cartridges became more common after the late 1860s, Sharps long rifles and carbines alike proliferated in calibers ranging from the massive .50-90 and .45-120 to the more

modest – at least by the standards of the day – .45-70 Government. Despite the terrific compactness and handiness of the falling-block action, eventually Sharps lost ground to magazine-fed repeater actions. The only repeating development ever to come from the falling block, ever so peripherally, was the 1904 Danish Madsen light machine gun. The large cartridges typical of Sharps rifles became the other factor working against their popularity. By the end of the 19th century, .45-70 or larger gave way to smaller, higher velocity calibers that were easier on the shoulders and budgets alike. So the canonical big bore remained present but uncommon for nearly a century. Cowboy Action Shooting and the movie “Quigley Down Under” gave the Sharps design, now mostly produced by Italian companies like Chiappa, a new chance at popularity.

With more young and female shooters entering the ranks of recreational rifle enthusiasts, it's no surprise that the Half-Pint Sharps, reduced about 20 percent linearly and nearly 40 percent by weight, gained considerable popularity. As is usual with Taylor's imports, this rifle has good wood-to-metal fit, and a very nice casehardened finish on the receiver. Chambered in .44-40 Winchester, a late 19th century ballistic analog of the more modern 10mm Auto, the Taylors Half-Pint brought the quaint but efficient manual of arms, along with

the accuracy, to a wider audience. A slightly bottlenecked cartridge capable of 1250 fps with a 200-grain flat point lead bullet, .44-40 is loaded for cowboy action shooting by Black Hills to around 800 fps. In that form, .44-40 produces no perceptible recoil and only a mild report. The slight bottlenecking of the case aids extraction, but does slow down the reloading of cases a little.

Loading the Sharps carbine is simple: set the hammer at half cock, pull the lever down to drop the breechblock, then load the cartridge straight into the chamber. The process is complicated slightly by the weight of the opened lever pulling the action slightly closed at times, or forcing the extractor back and retracting the loaded cartridge partway out of the chamber. Both have the effect of preventing the bolt from sliding up to close the action. Using the support hand to hold the lever all the way forward removes this annoyance.

In keeping with the long-range reputation of the bigger Sharps guns, this Mini came equipped with a folding Creedmoor tang sight adjustable for elevation. The front of the two double triggers provided emergency short-range release, but the 13-pound pull weight made it impractical for accurate shooting at distance. The similarly heavy curved rear trigger may be pulled first, setting the front to much more reasonable 2-1/4 lbs. In test

firing, we found that the peep sight opening was small enough to cause some diffraction, and also a considerable reduction in the availability of light – not surprising, as Taylor's rates this sight “for daylight use.” The same aperture effect helps focus the front sight nicely. Unfortunately, even the small aperture closer to the eye did not make this sight as accurate as we had hoped: several good marksmen ended up with 3- to 4-inch groups at 100 yards, with tight clusters of hits and outliers indicating that the limitation wasn't in the mechanical accuracy of the gun itself. The rifle was perfectly good for hitting medium game or bad hominids past a hundred yards, but the whole configuration of it implied far better accuracy. We also found elevation adjustments frustrating: the frame of the tang sight had unlabeled hashmarks, and adjustments were done by unscrewing the aperture slightly to permit vertical travel. Most of the time, the sight would slide too much upon release, with no way to determine its original position.

Wishing to test this theory, I mounted a 4x reproduction of the 19th century Malcolm scope made by Hi-Lux onto the Half-Pint. A thin externally adjusted tube; this scope was an externally faithful copy of the late US Civil War scopes possessed of better optical clarity thanks to modern production techniques. Zeroed at 25 yards, the scoped rifle printed cloverleaves consistently. With the scope, 100-yard groups tightened up to 1.5 MOA, quite good for essentially a pistol round. With the scant 1.4-inch scope height over the bore line, 100 yards is the longest practical point blank range with an 80-yard zero, assuming the enemy is a five-inch tall pop can. With the Malcolm scope having a relatively small, clear aperture, it provided good focus down to 15 yards or so, while still gathering enough light to work on indoor ranges. The long eye relief came in handy, as even the Half-Pint retains a longish 14-inch length of pull. While the Malcolm scope uses only the historically accurate crosshairs,

drop compensation may be done on the basis of target size, as in “hold on the head to hit center mass” or “two crows above the actual one.”

Light at six pounds and well balanced, the Half-Pint became a real crowd pleaser at every range outing. Scoped and fired with full-power ammunition providing 150-yard

**“With more young and female shooters entering the ranks of recreational rifle enthusiasts, it's no surprise that the Half-Pint Sharps, reduced about 20 percent linearly and nearly 40 percent by weight, gained considerable popularity.”**

point blank range on small game, it is a competent performer out to 200-plus yards and, with accurate rangefinding, even further than that. Its velocity doesn't drop below 800 fps – the muzzle velocity of the cowboy-action load – until the 300-yard mark. Winchester/Olin produces a 1200 fps 200-grain power point load that's well capable of taking down deer at reasonable ranges. For those who also favor old-Western-style .44-40 six-shooters, the Half-Pint Sharps can be a stylish and functional medium-range companion to the more rapid-fire sidearms.

**Taylor's & Company**  
304 Lenoir Drive  
Winchester, VA 22603  
540-722-2017 • [taylorsfirearms.com](http://taylorsfirearms.com)

**Hi-Lux Optics**  
3135 Kashiwa Street  
Torrance, CA 90505  
310-257-8142 • [hi-luxoptics.com](http://hi-luxoptics.com)

# SAVE YOUR BRASS!

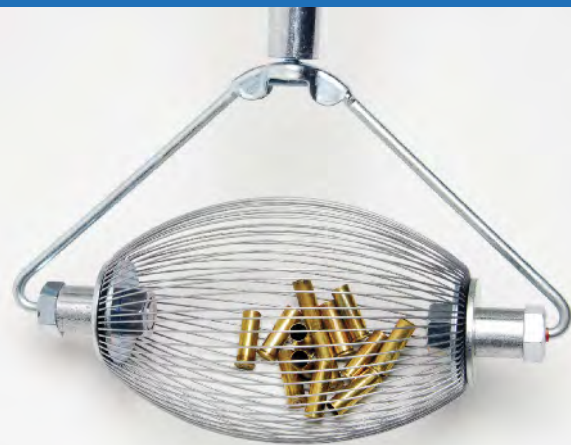

Pick up your brass the easy way! This takes the hard work out of policing up your brass. No more aching back from bending over or kneeling at the range!

O86-21894 \$44.95



The **SHELLSORTER** is a simple product designed to reduce the time you spend sorting brass, allowing you to enjoy more time reloading and shooting. The **SHELLSORTER** is comprised of three pans designed to sort several common calibers. The fastest way to sort is to stack all three of the pans together on a common five-gallon bucket, yellow pan on top and black on the bottom; in that way, with a few shakes all your brass is sorted by caliber at the same time. The **SHELLSORTER** is made of ABS, a strong plastic that will give a lifetime of service.

O86-19972 \$39.95

## Berry's Manufacturing Pan Sifter



An injection molded pan sifter that fits on top of a bucket to separate your brass from cleaning media.

Berry's Mfg. Pan Sifter O86-17519 \$9.99

## Outers 51-Piece Screwdriver Kit



Includes a form-fitted case, a magnetic-tip driver, 15 flat head, 10 inch hex, 9 metric hex, 4 Phillips, 9 Torx, 2 extra long Phillips bits and 1 hex-to-square adapter.



O86-10281 \$19.95

## Dial Caliper<sup>^</sup>

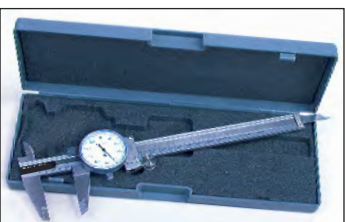

- .100 per revolution.
- Covered track for longer caliper life – keeps chips out!
- Made of hardened stainless steel.
- Satin chrome finish. No glare.
- Easily read to .001-inch on large, adjustable dial.
- Measuring faces hardened, ground and lapped.

O86-13462 \$28.00

## High Tech Digital Caliper<sup>^</sup>



Accurate, Easy to Read!

O86-17171 \$39.95



Nobody's perfect. A bullet puller makes it easy to recover all your components.

- Bullet Puller<sup>^</sup> O86-17999 \$29.95
- Puller Cap<sup>^</sup> O86-17948 4.95
- Collet Set O86-17947 5.99

<sup>^</sup> **WARNING:** The products offered for sale in this catalog can expose you to chemicals, including BPA's, which are known to the State of California to cause cancer, birth defects or other reproductive harm. For more information, go to [www.P65Warnings.ca.gov](http://www.P65Warnings.ca.gov).

# RANGE TIME. ANYTIME.

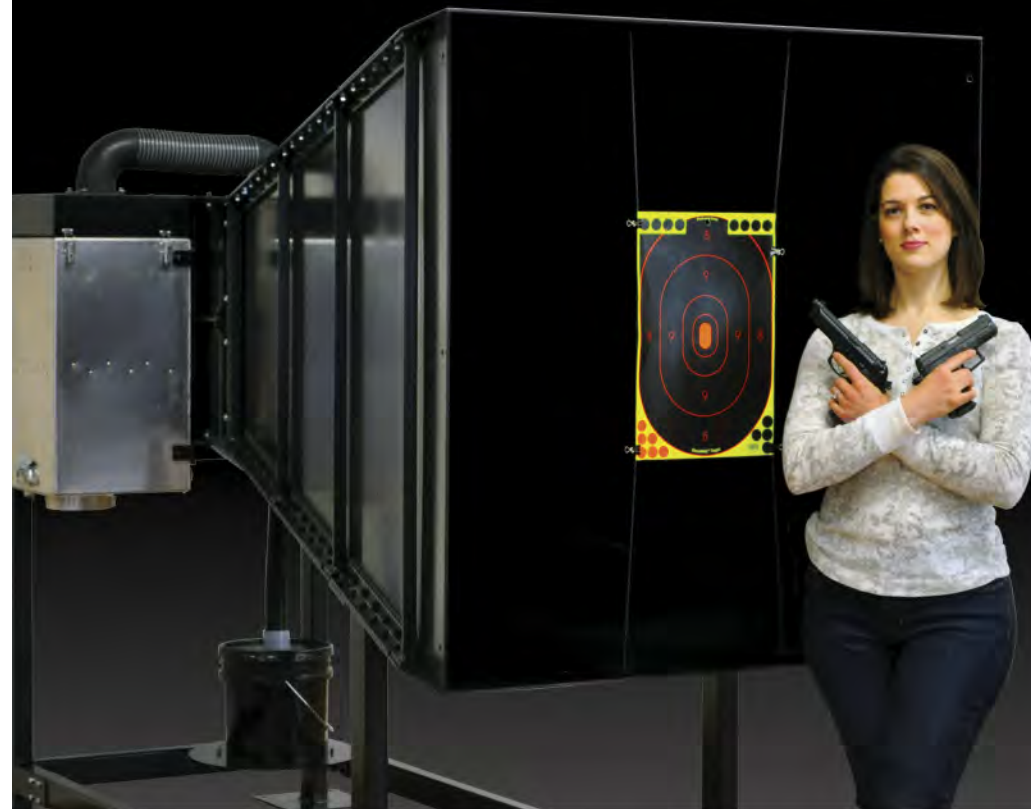

Our Pistol Perfect bullet traps make range time, anytime a real possibility.

Available in 3 different sizes, each trap can handle handgun calibers up to .44 Magnum, and rifle calibers up to .223/5.56mm.

Our patented bullet trap technology ensures the shooter of a safe, clean, virtually maintenance free way to target practice. Lead is deposited into a collection pail, which can be recycled or sold. Talk about convenience!

Visit our website to see which Pistol Perfect Trap will work best for you.

**Bullet Trap**  
USA

[WWW.BULLETTRAPUSA.COM](http://WWW.BULLETTRAPUSA.COM)

(860) 673-7068





# 48 FROM FACTORY TO WILDCAT

## The “Why” and the “How” of Precision Reloading

By John Bibby

One of the reasons precision shooters almost always end up becoming reloaders is that it allows them to fine-tune a load to their particular gun. This continues with the ability to fine-tune the seating depth to compensate for the chamber throat erosion.

With 6.5 Creedmoor, the factory loads report velocities between 2625 and 2915 fps with a 120-grain bullet. Simply switching to reloading will allow you to increase the range to 2825-3010 fps. Maximum velocity often is not where you find the greatest accuracy; however, a larger velocity scale helps to find the lower and the higher velocity accuracy nodes in your load-testing ladders.

For example: Using 120-grain projectiles and loads listed for RL-17 powder, the maximum velocity is roughly 3010 fps. In many guns, the high velocity accuracy node happens at roughly 2880-2910 fps. The groups are not that tight below this velocity. When the velocity is in this range, the group tightens by about 30 percent. The groups tend to open up by a similar amount as you move higher up the velocity ladder.

For many, a similar accuracy node also happens in the 2675-2750 fps range. For those willing to deal with the additional drop and wind drift, this lower velocity node generates less recoil and much greater barrel life. The faster velocity node advantage is stretching out the effective distance.

Adjusting the seating depth to adjust how far from the lands the bullet sits can further finesse the accuracy node. The bullet-depth technique is much more useful in a bolt-action rifle, as it is not limited by the magazine length. All semiauto guns will be much more limited on combined overall length due to magazine limits and reliability of feeding. In bolt-action guns, this also allows you to somewhat compensate for erosion of the lands by gradually increasing the length to keep the same distance from the lands.

In reloading for your specific gun, testing will determine where you find your accuracy nodes, but commonly used recipes give a guideline and a predictive method for expectations. Empirical testing also allows you to determine if a slightly lesser recoiling and slightly less barrel burning recipe is better for your application.

Another great advantage to reloading is you can change the projectile used. Some guns will not ever give acceptable accuracy with a certain brand of bullet. A certain barrel will not like one bullet in a weight range, but will love another. This usually has to do with bullet length, bearing surface or the profile of the nose of the bullet. Without getting into the science of why, it's much simpler to load bullets from different manufacturers and see what the results are in your gun.

This can also happen with a bullet weight. If your gun or barrel just doesn't like 120-grain bullets, then try various 140-grain projectiles and see what your results are. Maximum velocities will be lower with this weight of bullet (factory loads are from 2540-2720 fps), but you will have a better ballistic coefficient. The improved aerodynamics will help to offset the lower velocity both in long-range drop compensation and in fighting wind drift.

For those who truly need the absolute fastest velocities, the caliber itself may need to change. If the shooter isn't able to get the desired combination of accuracy and velocity with 6.5 Creedmoor, there's always the jump up to 6.5x284. Significantly more powder pushes the bullet and, using slower-burning powders, the shooter can make use of longer barrels. While in 6.5 Creedmoor, most loads don't gain velocity beyond 24" barrels, with the 6.5x284 improvement can be seen up to 30".

The larger 6.5 cartridge, in the hands of reloaders, is fully capable of sending a 140-grain bullet at 2920-3025 fps. In my personal bolt-action rifle, my accuracy node dials in at about 2950 fps with a 140-grain Berger VLD Target. This is at about 1.0 grain below a maximum load.

I'm currently working up a load for the Hornady 147-grain ELD Match. Preliminary data shows that my accuracy nodes will be at a slightly lower velocity, but the loading depths will not need to be nearly as precise as the Berger VLD and the better ballistic coefficient balances out for the lost velocity. In theory, this will provide more consistent accuracy as loading precision is not as hyper important.

Once you've been bitten by the accuracy bug, you're no longer concerned with the cost savings of reloading. It really is a function of making super

**“Once you've been bitten by the accuracy bug, you're no longer concerned with the cost savings of reloading. It really is a function of making super accurate rounds that factory ammo just can't replicate.”**



John's rifle is a Savage 12 F Class chambered in 6.5x284 Norma equipped with a Leupold VX-6 7-42x56mm scope.

accurate rounds that factory ammo just can't replicate. There is the side benefit (if reloading time is not included in the cost) that an equal amount of dollars allows much more ammunition for practice and practice is where repeated accuracy is built.

Some shooters will not find what they want even with the 6.5x284. This is where wildcats come in. The 6.5x284 is a wildcat that gained factory support after beginning life as a necked-down .284 Winchester. Ironically, with the advent of much better 7mm (.284 diameter) bullets many people are heading back to the .284 Winchester parent cartridge and its derivatives.

With reloading, the shooter has unlimited options as to how to perform the desired task. If 6.5x284 is not quite where the shooter needs to be, the chamber can be modified to further increase case capacity. Some F-class competitors have done exactly that by “Ackleyizing” the 6.5x284. Others have chosen to push a lighter 6mm bullet to hyper velocities. Others have chosen to use the original parent .284 cartridge with “Ackley” style improvements. Some have even taken the 6.5 bullet into a completely different case, like a necked-down .300 Winchester Magnum or .300 Weatherby Magnum, in search of greater velocity.

Each of these decisions has advantages and disadvantages. Moving from the 6.5 Creedmoor to the 6.5x284 provides the shooter gains in velocity

and the option of much heavier/ballistically more efficient bullets. This comes at the cost of 50-75 percent shorter barrel life. New Creedmoor brass runs \$0.45 to \$0.75 and there are some outlets for once-fired brass. For 6.5x284 brass, prices range from \$0.90 to \$1.40 with no once-fired brass available. There's also a significant decrease in the number of reloads when you step up to the larger case. Most people claim 8-12 loads on the Creedmoor. I've not heard of anyone claiming more than 10 with the 6.5x284 and most stop using the brass in competition after four to six uses.

The options open to someone willing to pursue the ultimate in velocity or accuracy are really only limited by physics, imagination and the depth of your checking account. Typically, shooters travel the path from bulk ball to factory match in common calibers to specialized precision calibers to wildcats as their skill level exceeds the performance of the current gun fodder.

**About the author:** John Bibby, a lifelong gun enthusiast, has always pushed the envelope. He started shooting at age 5, shooting his first Uber Thumper, a .375 H&H, by age 9. Since then, he has caught the accuracy bug hard, leading to increasingly deep and detailed interest in precision reloading. He shoots a 24" barrel AR for wind-reading practice, and a 30" barrel F-class 6.5x284 for more reliable long-range results. John also shoots 3-gun matches.

# 50 "Big Fifty Reloader"

## STANDARD FEATURES:

- 4-Station Interchangeable Toolhead
- Uses Std. 1-1/2"-12 UNF Thread Dies
- Manual Shellplate indexing
- Average Loading Rate: 300 Rds./Hr.
- Loads High Volume/Match-Grade Ammo
- Milspec/Match-Grade Priming System
- Ductile Iron/Carbon Steel Construction

All for ONLY...  
**\$1119<sup>95</sup>**  
 086-50000

Now Available!  
**.408 CheyTac Conversion**  
 086-50204 \$149.95  
 (Dies NOT Included)



Total price as pictured here with optional accessories: \$2789.75

.50 BMG Carbide Size Die	086-50075	\$969.95
.50 BMG Case Trimmer	086-50050	\$399.95
BFR Mounting Post (50.5" High)	086-50150	\$289.95
BFR Mounting Hardware Kit	086-50140	\$9.95

## BFR Accessories

### A. 50 BMG CASE TRIMMER ASSEMBLY<sup>^</sup>

Features an industry standard 1-1/2"-12 UNF threaded body, a 1/4 HP motor, replaceable carbide cutter, quick-disconnect cord and includes the .50 BMG trim die.

086-50050, \$399.95



### B. 50 BMG CARBIDE SIZE DIE<sup>^</sup>

The only .50 BMG size die in the industry that's a full-length solid carbide size die, for increased die life and scratch resistance. It also has a solid carbide expander ball, placed in the middle of the power stroke for easier operation. The die body is standard 1-1/2"-12 UNF thread, and is manufactured to low chamber tolerance specifications.

086-50075, \$969.95

### C. 50 BMG POWDER MEASURE ADAPTER<sup>^</sup>

For use with the RCBS .50 BMG powder measure.

086-50125, \$77.95



### D. 50 BMG PRIMER SEATING DIE<sup>^</sup>

One of these is included with Dillon's Big Fifty Reloader, but may be used as an accessory on a separate toolhead. The primer seating die is adjustable for enhanced control of primer seating. Includes two primer punches: one flat, match-style primer punch and one cupped, MIL-SPEC primer punch.

086-50200, \$149.95



### E. 50 BMG PRIMER POCKET SWAGER<sup>^</sup>

Makes it easy to remove the military crimp.

086-50001, \$334.95

### E. (1) PRIMING CONVERSION<sup>^</sup>

Converts Swager to Priming System.

086-50003, \$79.95

### F. 50 BMG PRIMING SYSTEM<sup>^</sup>

Allows off-the-machine primer seating.

086-50002, \$334.95

### F. (1) SWAGER CONVERSION<sup>^</sup>

Converts Priming System to Swager.

086-50004, \$79.95



EXTRA "BFR" TOOLHEADS 086-19831, \$189.95

### RCBS .50 BMG LOADING ACCESSORIES<sup>^</sup>

.50 BMG Powder Measure	086-21896, \$114.95
.50 BMG Seat/Crimp Die	086-21895, \$139.95



Dillon's "Plan B" Day Planner Holster<sup>^</sup> holds a handgun and a spare magazine or pepper spray, yet it fits in with business clothing and won't draw undue attention. It looks like a typical day planner, but inside there's a holster that's adaptable for either right- or left-hand draw. It fits most .380, 9mm, .40 and .45 caliber autos, including: Beretta, Colt, GLOCK, HK, Kahr, Kel-Tec, Ruger, Taurus, SIG, and Smith & Wesson. Will also hold small-frame revolvers with two- to four-inch barrels.

"Plan B" Day Planner 086-10252 \$24.95



## SACK-UPS

Sack-Ups Protective Gun Sacks		
Sand Viper AR-15	086-17378	\$28.99
Sand Viper M24 Bolt Rifle	086-17348	28.99
Handgun, 13.5" Gray	086-17249	7.99
Handgun, 13.5" Black	086-17250	7.99
Handgun, 13.5" Natural	086-17252	7.99
Shotgun, 42" Black	086-17253	10.99
Rifle/Shotgun, 52" Gray	086-17247	8.99
Rifle/Shotgun, 52" Black	086-17248	10.99
Rifle/Shotgun, 52" Natural	086-17251	8.99
Muzzleloader, 72" Gray	086-17254	11.99
Shotgun Rcvr., 24" Gray	086-17257	8.99
Shotgun Bbl., 36" Gray	086-17256	8.99
Sack-Ups Old West Gun Protection		
Single-Action Revolver	086-18000	\$8.99
Lever-Action Carbine 42"	086-18001	10.99
Buffalo Rifle 48"	086-18003	10.99

## YOU Can Wear The "Dillon" Brand



Dillon Precision, Long Sleeve		Dillon Precision, Short Sleeve	
Navy, Large	086-18507 \$19.95	Navy, L	086-18511 \$12.50
Navy, XL	086-18508 19.95	Navy, XL	086-18512 12.50
Navy, XXL	086-18509 20.95	Navy, XXL	086-18513 14.50
Navy, XXXL	086-18510 22.95	Navy, XXXL	086-18514 14.50
Gray, Large	086-18523 19.95	Gray, Large	086-18527 12.50
Gray, XL	086-18524 19.95	Gray, XL	086-18528 12.50
Gray, XXL	086-18525 20.95	Gray, XXL	086-18529 14.50
Gray, XXXL	086-18526 22.95	Gray, XXXL	086-18530 14.50
Black, Large	086-18515 19.95	Black, Large	086-18519 12.50
Black, XL	086-18516 19.95	Black, XL	086-18520 12.50
Black, XXL	086-18517 20.95	Black, XXL	086-18521 14.50
Black, XXXL	086-18518 22.95	Black, XXXL	086-18522 14.50

## Dillon's 1911 Action Impact Reducers<sup>^</sup>



An easy, affordable way to protect your favorite 1911's frame from being battered by recoil.

Action Impact Reducers (6 ea.) 086-20516 \$4.95

## Dillon Bushing Wrench<sup>^</sup>



086-11049 \$2.50

## THINKING ABOUT BURYING SOME GUNS?



These 532 gram DESI<sup>®</sup>PAK desiccants absorb moisture better than silica gel. It's an industrial grade material that exceeds the requirements of Mil Spec MIL-D-3464E. Now available in smaller packages for other applications (ammo cans, long-term storage containers, etc.).

DESI <sup>®</sup> PAK (2 bags, 1 card)	086-21435	\$16.95
4-ounce bag	086-14694	4.95
2-ounce bag	086-14695	2.95
Humidity Indicator Card, 6 pack	086-21523	4.95

**WARNING:** The products offered for sale in this catalog can expose you to chemicals, including Lead, which are known to the State of California to cause cancer, birth defects or other reproductive harm. For more information, go to [www.P65Warnings.ca.gov](http://www.P65Warnings.ca.gov).

# 52 REDDING Reloading Dies & Accessories

**Micro-meter-Adjustable Competition Seating Dies (These are individual dies.)**

**Competition Pistol Seating Dies**

9mm O86-10671 \$91.95  
 .38 Super Auto O86-10672 91.95  
 .38 Sp./357 Mag. O86-10673 91.95  
 .40 S&W/10mm O86-10674 91.95  
 .44 Sp./44 Mag. O86-10675 91.95  
 .45 ACP O86-10676 91.95  
 .45 Colt/.454 Casull O86-10677 91.95

**Competition Rifle Seating Dies**

.45-70 Gov't O86-11197 \$91.95

**Complete Three-die sets - Size, bell, seat**

.32 ACP O86-15521 \$106.00  
 .32-20 Winchester O86-11906 106.00  
 .38-40 Winchester O86-11838 140.00  
 .38-55 Win./Ballard O86-19106 140.00  
 .44-40 Winchester O86-11692 78.00  
 .45-70 Gov't O86-12700 106.00  
 .460 S&W O86-10319 106.00

**Complete Two-Die Sets**

.204 Ruger O86-12547 \$78.00  
 .22 Hornet O86-11484 78.00  
 .220 Swift O86-12182 78.00  
 .22-250 O86-15761 78.00  
 .224 Valkyrie O86-10316 106.00  
 .243 Winchester O86-15762 78.00  
 .243 WSSM O86-11193 47.95  
 6mm Creedmoor O86-10315 106.00  
 .25-06 Remington O86-12183 78.00  
 .25 WSSM O86-11194 82.35  
 .260 Remington O86-09997 78.00

.270 Winchester O86-10822 78.00  
 .270 WSM O86-18337 47.95  
 6.5 Creedmoor O86-71005 78.00  
 6.5 Grendel O86-19893 140.00  
 6.5 x 55mm O86-11353 78.00  
 6.8 SPC O86-12548 106.00  
 7 x 57mm Mauser O86-11212 78.00  
 7mm WSM O86-18339 64.95  
 7mm Rem. SA UM O86-18338 64.95  
 7mm RUM O86-18340 64.95  
 7mm Rem. Mag. O86-11775 78.00  
 7mm-08 Remington O86-12041 78.00  
 7.5mm Swiss O86-09995 140.00  
 7.62 x 39mm O86-12045 106.00  
 .30-30 Winchester O86-29020 78.00  
 .30-40 Krag O86-11835 140.00  
 7.62 x 54mm O86-09994 106.00  
 .300 AAC Blackout O86-12550 106.00  
 .300 WSM O86-15763 78.00  
 .300 Rem. SA UM O86-18341 156.00  
 .300 RUM O86-18342 78.00  
 .300 Weatherby O86-11354 78.00  
 .300 Win. Mag. O86-12046 78.00  
 .303 British O86-11691 106.00  
 8 x 57mm Mauser O86-09996 78.00  
 .338 Win. Mag. O86-11774 78.00  
 .338 Lapua Mag. O86-21354 140.00  
 .458 SOCOM O86-10320 140.00

**Individual Dies: Neck-Size-Only Dies**

.223 Remington O86-10164 \$53.00  
 .22-250 O86-11184 53.00  
 .224 Valkyrie O86-10318 71.00

.243 Winchester O86-10172 53.00  
 6mm Creedmoor O86-10317 71.00  
 .25-06 O86-11336 53.00  
 .260 Remington O86-09993 53.00  
 .270 Winchester O86-11806 53.00  
 7mm Rem. Mag. O86-11392 53.00  
 .308 Win./7.62 O86-10165 53.00  
 .30-06 O86-11763 53.00  
 .300 Win. Mag. O86-11108 53.00

**Crimp Dies**

.32 S&W/H&R Mag. O86-11747 \$27.95  
 .45-70 Gov't O86-11977 35.95

**Powder Measure, Reloading Accessories**

Match-Grade Model 3 BR Measure O86-10121 \$184.00  
 Large (7.5") Powder Reservoir O86-10123 \$16.00  
 X-Large (10") Powder Reservoir O86-10124 \$19.00  
 Powder Trickler O86-11986 \$38.00  
 Stuck Case Removal Kit O86-12186 \$28.00

**Specialty/Custom Die Sets<sup>A</sup>**

.50 AE O86-14514 \$49.95  
 (Incl: RCBS steel size, expander, seat/crimp)

.500 S&W O86-11114 \$49.95  
 (Incl: RCBS steel size, expander, seat/crimp)

RCBS Carbide .500 S&W Size Die only O86-19923 \$40.95



# Grace USA Gun Care Tool Set 53



This custom designed 12" x 9" x 1-1/2" case is made from durable soft Nukaf and contains a 17-piece set of Grace USA Gun Care Screwdrivers (8 ea.), Solid Brass Pin Punches (8 ea.) and a specially fabricated 8 Oz. Brass Hammer. The screwdrivers are hand-assembled and custom hollow ground to fit scope screws, plug screws, guard screws, etc. The handles are turned from quality Maine hardwood and protected with a smooth finish. Made in USA.

Grace USA Gun Care Tool Set<sup>A</sup> O86-10680 \$99.95

## More Great Tools From Grace USA!

The 9-Piece Ball-End Allen Head Screwdriver Set includes the following sizes: 1/16", 5/64", 3/32", 7/64", 1/8", 9/64", 5/32", 3/16", and 3.5 mm. Each is constructed of US 8650 Chromium-Vanadium steel alloy and is proudly Made in USA!

Ball-End Allen Set O86-15063 \$49.95

The 7-Piece Steel Roll Pin Punch Set includes the following sizes: 1/16", 5/64", 3/32", 1/8", 5/32", 3/16", and 7/32". Each is proudly Made in USA!

Roll Pin Punch Set O86-15065 \$39.95

## Dillon's Bench Wrench Fits 1" Die Lock Rings



A characteristic of virtually all progressive reloading machines, regardless of brand, is that the dies are set rather close together. When you are first setting up a "naked" machine, there is plenty of wrench room, but if you have a need to adjust a die afterward, it often requires a delicate touch to maneuver a lock ring on a crowded toolhead.

Dillon Precision has addressed this in two ways. We now offer new 1" die lock rings and a 1" Bench Wrench to fit them. This combination gives much more room to

re-adjust dies after they're already mounted. The opposite end of our new wrench is a 7/16" box-end for adjusting the Powder Bar of any Dillon Powder Measure. Our new lock rings fit any standard 7/8" x 14 dies.

1" Dillon Die Lock Ring O86-14067 \$1.60  
 5-Pack of Die Lock Rings O86-10669 4.95  
 1" Dillon Bench Wrench O86-10842 7.95  
 (Buy two or more 1" Bench Wrenches for \$7.10 each)  
 Wrench/Lock Ring 5-Pack O86-10668 9.95

## Bondhus Hex Key Sets



Ball-end set O86-13286 \$12.95  
 Gorilla Grip Sm. O86-16822 5.45  
 Gorilla Grip Lg. O86-16823 6.35  
 Gorilla Grip Set O86-22142 10.75

## Secure Firearms Products Recoil Spring Tester



Secure Firearms Products' Universal Spring Tester will help you determine if the recoil spring in your pistol needs replacing, and you'll save time and money by testing and organizing loose recoil springs in your shooting bag.  
 O86-15305 \$39.95

## 10-8 Performance Armorer Tool



The 10-8 Performance Armorer Tool is a simple, non-marring tool useful for applications where prying or poking with metal tools can easily damage your work. The rigid chisel-pointed end and semi-flexible flat blade end each have unique uses.  
 O86-15434 \$7.95



Grace USA Gunsmith Hammer and Punch Sets<sup>A</sup>

8 oz. Brass Hammer O86-14969 \$14.95  
 16 oz. Brass Hammer O86-15069 18.95  
 Brass Punches (8-Pc.) O86-14968 31.95  
 Steel Punches (7-Pc.) O86-15070 31.95  
 8 oz. Brass Hammer & 8-pc. Brass Punch Set O86-21655 39.95



The Tru-Weight Trigger Tension Scale has a range from eight ounces to eight pounds. A unique weight indicator remains at the exact point of trigger release, making it easier to read your trigger pull pressure.  
 O86-14838 \$26.95

## Barrel-Lite<sup>®</sup>

O86-10529 \$4.95

<b>Pistol Targets: 100 per package</b>		
NRA Paper D-1 "Tombstone" Target 23"x35"	O86-18388	\$44.00
IDPA Paper Practice Target 22"x34"	O86-15735	39.95
USPSA/IPSC Paper Practice Target 22"x35"	O86-15836	39.95
50 Foot TIMED/RAPID FIRE 10.5"x12"	O86-15832	12.00
Competition 50 Foot SLOW FIRE 10.5"x12"	O86-15831	12.00
Competition 25 Yard SLOW FIRE 10.5"x12"	O86-13096	12.00
Police B-34 (Silhouette) 25 Yard 14"x24"	O86-13163	17.00
Police BH-21 (Silhouette) 25 Yard 22.5"x35"	O86-10094	37.00
Competition 25 Yard RAPID FIRE 21"x24"	O86-12839	24.00
Competition 50 Yard SLOW FIRE 21"x24"	O86-10041	24.00
Police B-27 (Silhouette) 50 Yard 22.5"x35"	O86-10670	37.00
<b>Rifle Targets: 100 per package</b>		
Small Bore Rifle 100 Yard 14"x14"	O86-12430	\$11.00
High Power 200 Yd. 21"x24" (600 Yd. reduced)	O86-12650	46.00
ST-4 100 Yard Precision Rifle Target 15"x17"	O86-13679	16.00
<b>Replacement Center 100 per package</b>		
Pistol 25 Yard B8P Repair Center 10.5"x10.5"	O86-12676	\$7.00
200 Yard Rifle Repair Center 12.75"x12.75"	O86-15830	20.00
<b>See Hit Targets 12 per package</b>		
SH-B8CRC Pistol 25 Yard Repair Center 10"x10"	O86-16328	\$9.00
SH-H-1 8 Inch Sighting Target 10"x10"	O86-16329	9.00
<b>Target Pastes</b>		
Black, Self-Adhesive, 500 ea.	O86-16304	\$3.50
Buff, Self-Adhesive, 500 ea.	O86-16309	3.50
Brown, Self-Adhesive, 500 ea.	O86-16310	3.50
White, Self-Adhesive, 500 ea.	O86-16313	3.50
Orange, Self-Adhesive, 500 ea.	O86-16327	3.50

### 3 Gun Ammo Bags

**TUFF** Products 3 Gun Ammo Bags (Set of 3) are made of 1000 Denier Cordura® and equipped with dual 550 cord cinch strings for secure closure. The Red/Blue bags hold up to 200 loose pistol/rifle rounds and Black bag holds up to 200 loose shotgun rounds.

O86-15773 \$19.95

### D•WIPE Towels ESCA TECH, INC.

**D•WIPE** Towels were specially designed for immediate clean up of most contaminants without water. The soft 5.5"x 8" towels are saturated with a unique cleansing formula and aloe vera, and will remove heavy metals from skin and other surfaces.

40 Soft Towels O86-19916 \$4.95

### D•LEAD Hand Soap ESCA TECH, INC.

**O**riginal **D•LEAD** Hand Soap quickly cleans heavy metals as well as paint dust and firing range residue from the skin and fingernails. Removes lead, nickel, cadmium, arsenic, mercury, silver, zinc and most other heavy metals.

8 Oz. Bottle O86-19915 \$2.95

### Comtech's STINGER

**THE STINGER:** Comtech's own personal defense device. Designed to act as a "force multiplier," it's like having the punching power of a karate master – instantly! There's really nothing like it for easy carry and access. It passes unnoticed by 90 percent of people who see it. Yup, just another "keychain device" to most, and yet it works so well when needed. You deserve a Stinger today!

O86-20510 \$26.95  
 O86-20511 \$24.95  
 O86-20512 \$24.95  
 O86-20514 \$14.95

### Arredondo Accessories' Multi-Gun Chamber Flags

Made of tough nylon with a melting point of 480 degrees. Kit includes one shotgun chamber flag and one for your AR-15.

O86-19495 \$9.95

### MILDOT MASTER

Become a master at using a Mil Dot reticle with this ballistic slide rule! Comes with a 24-page instruction manual.

O86-14762 \$29.95

### HARTMAN MFG Target Stands

**Rugged! Portable! Easy-to-Use!**

One Target Stand O86-18237 \$49.95  
 A Pair of Stands O86-74493 91.95

One Hostage Target Adapter (Shown below attached to Target Stand – not included. Works only with Hartman target stands.) O86-11697 \$26.99

A Pair of Target Spikes O86-11393 \$26.99

# Elzetta

## Tactical Flashlight Mounts

Every Elzetta ZFH1500 Flashlight Mount for AR15 rifles and ZSM Tactical Shotgun Flashlight Mount comes with sizing adapters, giving the mount the ability to accommodate flashlights from 0.7 to 1.05 inches (18 to 27 mm) in diameter. This includes flashlights from popular manufacturers such as InForce®, Streamlight®, Pelican®, Laser Devices®, SureFire® and of course, the Elzetta® ZFL-M60. (Sizing Adapters are not required when using an Elzetta ZFL-M60 or other 1-inch lights.) The Elzetta ZSM is made from the same advanced glass-filled polymer that has proven itself in the popular Elzetta ZFH1500.

The NEW Elzetta ZRX Tactical Flashlight Mount is made for flashlights with standard one-inch bodies and will accommodate a range from 0.94 to 1.04 inches (23.8 to 26.4 mm). This includes many popular tactical flashlights including the Elzetta ZFL-M60. The Elzetta ZRX clamping rings are made from Mil-Spec Type III Hard Anodized aluminum, the body is a glass-reinforced polymer and the hardware is steel. The ZRX weighs 1.1oz (32g).

ZFH1500 AR15 Flashlight Mount O86-12020 \$29.95  
 ZSM Tactical Shotgun Mount O86-18050 39.95  
 ZRX Tactical Flashlight Mount O86-15487 35.00

## PROTEKTOR MODEL

### The Original Leather Sandbag\* Rifle Rests

All Protektor Model leather bags are made with the best top grain cowhide available. The welded steel rest is strong enough to stand on and won't break if dropped (Owl Ear Front Bag sold separately).

A. Front Bag O86-10880 \$24.00  
 B. Rifle Rest O86-10883 63.00  
 C. Std. Front Bag O86-10881 31.00  
 D. Rear Bag O86-10882 34.00

\*Sand not included.

## Viking Tactics V-TAC MK1 Sling

Viking Tactics' V-TAC MK1 Sling is quick, instantly adjustable to improve your shooting position, allows shooting from weak-side shoulder, secures the carbine during handgun transitions, and allows hands-free movement in difficult surroundings.

Viking Tactics Sling for CAR-15 O86-11961 \$34.95  
 Viking Tactics Sling for FN-FAL/HK-91 O86-11962 40.00

# 56 California Competition Works' Moon Clip Loading/Unloading Tools & Carriers

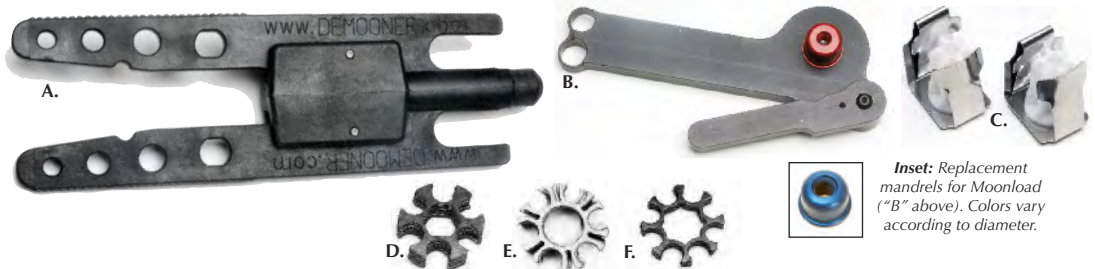

A. Demooner Tool	O86-18169	\$16.95	.590" Repl. MoonLoad Mandrel	O86-33400	8.00
B. MoonLoad/Unload 8-Shot .357	O86-19490	39.95	.596" Repl. MoonLoad Mandrel	O86-33401	8.00
MoonLoad/Unload 6-Shot .45	O86-19489	39.95	.620" Repl. MoonLoad Mandrel	O86-33402	8.00
(Works with #16510 8-shot EDM .38/.357 moon clips on Pg. 57)			.649" Repl. MoonLoad Mandrel	O86-33403	8.00
.483" Repl. MoonLoad Mandrel	O86-33395	8.00	C. 6-Shot Mn. Clip Holder (2 ea.)	O86-18173	17.90
.493" Repl. MoonLoad Mandrel	O86-33396	8.00	D. Blued .45 ACP Mn. Clips (10 ea.)	O86-18183	9.80
.510" Repl. MoonLoad Mandrel	O86-33397	8.00	Stainless .45 ACP Mn. Clips (10 ea.)	O86-18280	10.50
.530" Repl. MoonLoad Mandrel	O86-33398	8.00	E. 10mm Moon Clips (10 ea.)	O86-18184	11.20
.538" Repl. MoonLoad Mandrel	O86-33399	8.00	F. 8-Shot .357 Moon Clips (10 ea.)	O86-19228	19.95

**Inset:** Replacement mandrels for Moonload ("B" above). Colors vary according to diameter.

## North Mountain Speed Loader Holder

The North Mountain IDPA-Compliant Speed Loader Holder is made specifically for the competitive IDPA revolver shooter. Lightweight at 2.9 Oz., it firmly holds your competition speed loader. It is fitted with a Tek-Lok™ to mount to your range belt. It fits Comp III and similar-sized speed loaders.

"K-Frame" Model  
**O86-21900 \$35.00**

"L-Frame" Model  
**O86-21914 \$35.00**



## TK Custom Moon Clips

Chiappa Rhino 9mm/.40 S&W (10 Pk)	O86-12040	\$65.00
Chiappa Rhino .38/.357 (10 Pk)	O86-12043	65.00
N-Frame 9/.38 ACP 8-Shot (Blue) (10 Pk)	O86-12044	39.95
L-Frame 9/.38 ACP/.40 6-Shot (Blue) (10)	O86-12057	39.95
S&W N-Frame .45 ACP 6-Shot (10 Pk)	O86-12058	19.95
S&W N-Frame .45 ACP EDM 6-Shot (10)	O86-12059	74.95
S&W L-Frame .38/.357 7-Shot (10 Pk)	O86-12065	64.95
S&W L-Frame .38/.357 6-Shot (10 Pk)	O86-12066	64.95
S&W J-Frame .38/.357 5-Shot (5 Pk)	O86-12088	32.50
S&W K-Frame .38/.357 6-Shot (10 Pk)	O86-12090	64.95
S&W N-Frame .38/.357 8-Shot EDM (10)	O86-12091	64.95
N-Fr. .38/.357 8-rd. EDM Starline ONLY(10)	O86-12092	64.95
S&W N-Frame .38/.357 8-Shot (Blue) (10)	O86-12093	39.95

## SDM S&W Revolver Front Sights

<b>Pin-In Front Sight - \$28.00</b>		
.250" high, red	O86-18379	
.250" high, green	O86-18380	
.300" high, red	O86-18381	
.300" high, green	O86-18382	
<b>Pin-In Front Sight - \$44.95</b>		
.250" high, Gold Bead	O86-18565	
.300" high, Gold Bead	O86-18566	



## W.C. Wolff Co. Revolver Springs

<i>(Hammer/Trigger Return Springs)</i>		
Ruger GP-100	O86-11367	\$10.50
SP-101	O86-12598	9.50
S&W J-Frame		
	O86-12189	9.00
<i>(Mainspring/Rebound Springs)</i>		
S&W K,L,N (standard)		
	O86-15073	\$15.00
S&W K,L,N (reduced power)		
	O86-15072	15.00



**Jerry Miculek Competition Grips \$79.95**

S&W N-Fr. Rd. Butt O86-11324  
 N-Fr. Sq. Butt O86-11325  
 K, L-Fr. Rd. Butt O86-11327  
 K, L-Fr. Sq. Butt O86-11326



**Apex Tactical Specialties**  
 S&W J-Frame Duty/Carry Spring Kit O86-14309 \$25.95  
 S&W Revolver Frame-Mounted Firing Pin O86-21888 15.95



**Hogue Competition S&W Revolver Thumb Latch**  
 fits K, L, and N-Frames  
 Stainless O86-19921 \$59.95



**Hogue "Big Butt" Grips \$79.95**

S&W N-Fr. Rd. Butt O86-12141  
 K, L-Fr. Rd. Butt O86-12140

# 57 California Competition Works .22 LR Speedloader



## TUFF PRODUCTS QuickSTRIPS

**TUFF QuickStrips** are available for a variety of revolver calibers from .17 HM2 to .500 Linebaugh.

**\$8.50 for a package of 2.**

.22 LR-Mag./17HM2-HMR (10 rd.)	O86-11737
.32/.327/9mm (8 rd.)	O86-11738
.38/.357/.40/10mm (5 rd.)	O86-11740
.38/.357/.40/10mm (6 rd.)	O86-11741
.38/.357/.40/10mm (7 rd.)	O86-27083
.38/.357/.40/10mm (8 rd.)	O86-11742
.41Mag./45 ACP (6 rd.)	O86-11748
.44 Sp.-Mag./45 Colt/.460 S&W/.410 Shotshell (6 rd.)	O86-11750



**California Competition Works' 10-Round Speedloader for S&W Model 617 .22 LR Revolvers** is ideal for Steel Challenge or Ruger Rimfire Series competition. The speedloaders are machined from 6061 T6 aluminum, then black anodized. The Loading Block (inset photo) is CNC machined from polymer and holds 120 rounds of .22 LR ready for insertion into speedloaders.

CCW Model 617 Speedloader	O86-12623	\$34.95
Model 617 Speedloader Handle	O86-43385	10.00
CCW .22 LR 120 Rd. Loading Block	O86-12627	49.95
CCW .22 LR 240 Rd. Loading Block	O86-12599	100.00

## North Mountain Moon Clip Holder



I've tried several methods of holding my moon clips, and this works best for me! My hand only has to go to one place, so I no longer grope around frantically for my reloads. - Mark Pixler

N-Frames & 7-Shot L-Frames O86-21883 \$130.00

## Stainless EDM 8-Shot Moon Clips

**\$59.95**  
**O86-18510**  
 Sold in Packages of 10 for 8-Shot S&W 627 Revolvers

**These .025 EDM Stainless Moon Clips are designed to fit Remington brass SNUGLY, eliminating nasty "cartridge flop" when you reload.**

## Safariland Competition Gear for Revolver Enthusiasts



002 "Cup Challenge"	O86-17788	\$69.95
6" S&W K,L,N; Std. bbl.		
333 "Speedloader Holder"	O86-12411	\$34.95
S&W K-Frame	O86-12411	
S&W L-Frame	O86-13087	
"Competition Speedloaders"	O86-13117	\$19.95
S&W K-Frame	O86-13224	
S&W L-Frame	O86-13117	
Revolver "Speedloaders"	O86-12405	\$11.95
S&W J-Frame (5-Shot)	O86-13104	
S&W K-Frame	O86-13074	
S&W L-Frame	O86-13074	
"Speedloader" Holders	O86-10340	\$9.95
Sm./Med. Fr.	O86-10340	
"Speedloader Loading Blocks"	O86-12262	\$24.95
S&W K-Frame	O86-12262	
S&W L-Frame	O86-12878	

# 58 Performance Parts for Your GLOCK® Firearm



<b>GLOCK® Factory Original Parts:</b>		
A. Extended Mag Release (Small Frame)	O86-18569	\$9.95
B. Extended Slide Release	O86-18570	19.95
C. Striker Cups (The ones you always lose.)	O86-19325	4.95
D. Striker Channel Liner	O86-18881	9.95
<b>Lone Wolf Distributors' Parts for GLOCK firearms:</b>		
E. Extended Mag Release (Large Frame)	O86-19115	4.99
F. Extended Take-Down Lever	O86-19114	9.95
G. 3.5# Trigger Stop Connector	O86-16501	14.95
3.5# Trigger Stop Connector for G42/G43	O86-10111	19.99



**Lone Wolf Distributors' AlfaWolf Replacement Barrels**

GLOCK 17 9mm Barrel (Black)	O86-43350	\$139.95
GLOCK 19 9mm Barrel (Black)	O86-43352	139.95
GLOCK 22 .40 S&W Barrel (Black)	O86-43354	139.95
GLOCK 22/31 9mm Conv. Bbl. (Black)	O86-43356	139.95
GLOCK 23 .40 S&W Bbl. (Black)	O86-43358	139.95
GLOCK 23/32 9mm Conv. Bbl. (Black)	O86-43359	139.95
GLOCK 26 9mm Barrel (Black)	O86-43361	139.95
GLOCK 27/33 9mm Conv. Bbl. (Black)	O86-43363	139.95



**Lone Wolf Distributors' AlfaWolf Threaded Replacement Barrels (Thread Protectors ARE included)**

GLOCK 17 9mm 1/2"x28 Bbl. (Black)	O86-43351	159.95
GLOCK 19 9mm 1/2"x28 Bbl. (Black)	O86-43353	159.95
GLOCK 22 .40 S&W 9/16"x24 Bbl. (Blk.)	O86-43355	159.95
GLOCK 22/31 9mm Conv. 1/2"x28 Bbl.	O86-43357	159.95
GLOCK 23/32 9mm Conv. 1/2"x28 Bbl.	O86-43360	159.95
GLOCK 26 1/2"x28 Bbl. (Black)	O86-43362	159.95

*All AlfaWolf barrels are proudly made in the USA.*



**Lone Wolf Distributors' Slide-Completion Kit**

9mm GLOCK	O86-43367	\$84.95
.40 Cal. GLOCK	O86-43366	84.95
10mm GLOCK	O86-43364	84.95
.45 ACP GLOCK	O86-43365	84.95



**Lone Wolf Distributors' Ultimate Adjustable Trigger**

9mm/.40 Cal. GLOCK	O86-43375	\$74.95
10mm/.45 ACP GLOCK	O86-43376	74.95

## THE PLUG \$7.95

**For Pre-Gen 4 GLOCKS**  
 GLOCK® Models 17,19,20,21,22,23 (fit may vary)  
 Model 21SF  
 Models 26,27,33  
 Model 30

**For Gen 4 GLOCKS w/o Backstrap**  
 Models 17,18,19,22,23,24,25,31,32,34,35  
 Models 20,21,41  
 Models 26,27,33  
 Models 42,43

O86-18161	O86-19925	O86-10235	O86-10648
O86-12179	O86-12180	O86-60900	O86-60899

## Pearce Grip, Inc. Grip/Mag. Extensions

*Grip extensions do not alter mag. capacity.*

GLOCK® 26/27	O86-10346
G29 (10 rd.)/30 (9 rd. opt. mag.)	O86-10355
G30 (10 rd. mag. only)	O86-10356
G42	O86-10583
G43	O86-10584
Kel-Tec P11/Taurus PT111	O86-18586
Springfield XD (9mm/.40 only)	O86-18587
Springfield XD-S	O86-15286

*Mag. extensions add additional capacity.*

GLOCK® 10mm/.45 ACP (+2)	O86-18589
G27/33 (+1)	O86-18590
G42 (+1)	O86-10585
G43 (+1)	O86-10586

## STUL Slide Removal Tool Fits All GLOCK® Models

Engages the slide lock and provides a mechanical advantage making slide removal easier and faster. For those with large fingers, small fingers, tired fingers, anyone looking for a way to simplify the removal of your GLOCK® slide. **O86-19527 \$11.95**



## California Competition Works Enlarged Magwells for GLOCK® Pistols

GLOCK® 17, 19, 22, 23	O86-12523	\$46.00
GLOCK® 20, 21	O86-12525	46.00

## Lone Wolf Polymer Magazine Dissassembly Tool



O86-43374 \$12.49

## GTUL



Cleaning your GLOCK® magazines has never been easier! GTUL has developed an integrated system to disassemble and clean all GLOCK® magazines without marring, gouging, or damaging the metal liner. Quickly removes dirt, dust, powder residue and grime!  
 Standard Mags O86-20910 \$21.95  
 Large Mags O86-20911 21.95

## GLOCK® Mags



G-17	O86-11363	\$39.95
G-19	O86-15806	39.95
G-21	O86-15807	39.95
G-22	O86-11958	39.95
G-23	O86-11960	39.95
33-Rd. 9mm	O86-18806	39.95
G-42, 6 rd.	O86-10313	29.95
G-43, 6 rd.	O86-10312	29.95

## Arredondo Accessories +5 Mag Extension for MagPul PMAG 17 GL9 O86-33404 \$23.95



## MAGPUL Magazines for GLOCK® Pistols



The PMAG® 15 GL9™, PMAG® 17 GL9™, PMAG® 21 GL9™ magazines hold 15, 17 and 21 9mm Parabellum rounds respectively. *Note: Will not accept aftermarket floorplates designed for GLOCK® factory magazines. Instead, MagPul offers the GL L-PLATE™ Overmolded extension for GL9™ pattern PMAGs®. Note: Does not increase capacity.*

PMAG 17 GL9	O86-43287	\$15.95
PMAG 15 GL9	O86-20950	15.95
PMAG 21 GL9	O86-43399	19.95
GL L-PLATE 3-Pack	O86-20929	19.95

# HOGUE® Laser Enhanced (LE) Grips

Want immediate gains in your confidence when handling your 1911? Follow the red dot! Hogue's new laser-enhanced grip for your classic 1911 will dramatically improve your accuracy and speed in any defensive or competitive scenario. Designed, engineered and hand-made in America, proudly wearing the Hogue name, your new LE Grip will make almost every kind of shooter – including you – better and faster. Period. Also available for J-Frame Smith & Wesson revolvers.



LE 1911 Grip, Black **O86-43243 \$189.95**  
LE J-Frame S&W Grip, Blk. **O86-43244 189.95**



**Hogue Rubber OverMolded® AK-47/74 Handguard Kits**  
Standard Russian/Chinese Rifles **O86-14556 \$49.95**  
Yugo-Version Rifles w/Longer Guard **O86-14558 49.95**



The ERGO Grip Delta Grip™ is the first truly ergonomic grip for J Frame revolvers. Designed for the most important part of the gun, the shooter, the Delta Grip was engineered to fit the natural point of aim and mechanics of the human hand, wrist and arm. The result is a grip with a superior natural point of aim, comfort and control. Fits round butt J-Frames. Will not fit on Smith and Wesson Bodyguard 38 Model (sku 103037 and 103038). **O86-19684 \$19.95**

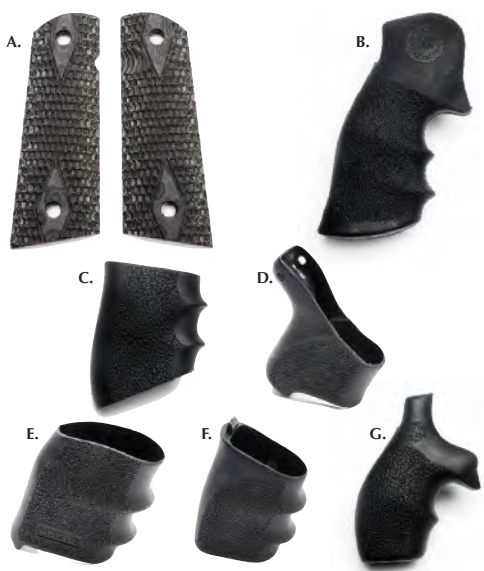

**Hogue eXTREME SERIES G-10 1911 Grips**  
(A.) For guns w/S&A-style magwells **O86-14562 \$59.95**  
**Hogue Square Butt Monogrips**  
Colt Python **O86-12138 \$26.95**  
(B.) K, L-Frame Square Butt **O86-12786 26.95**  
N-Frame Square Butt **O86-12145 26.95**  
N-Frame Round Butt **O86-18100 26.95**  
**Hogue Round Butt Monogrips**  
Ruger SP-101 **O86-14833 \$26.95**  
S&W J-Frame Round Butt **O86-12277 26.95**  
K, L-Frame Round Butt **O86-12549 26.95**  
**The Hogue HANDALL™ Grip Sleeve** fits many semi-autos.  
(C.) HandAll **O86-14463 \$9.95**  
**The Hogue HANDALL™ Hybrid Grip Sleeve**  
(D.) Ruger LCP .380 Auto **O86-14477 \$10.95**  
(E.) Springfield XD 9mm/.40 **O86-14478 10.95**  
(F.) Smith & Wesson M&P 9mm/.40 **O86-14479 10.95**  
**Hogue Bantam Boot Grips**  
(G.) S&W J-Frame Round Butt **O86-11054 \$26.95**  
K, L-Frame Round Butt **O86-11055 26.95**  
**Hogue Hex Head 1911 Grip Screws** (Four-screw set).  
Blue **O86-15723 \$8.99**  
Stainless **O86-15722 8.99**



An extra layer of padding helps absorb recoil and adds trigger reach for those with larger hands or long fingers. **O86-10181 \$29.95**

# Powder River Precision, Inc: Perfecting Your XD/XDm



**Powder River Precision X-Treme Grips: CNC Laser Cut 360° Grip Enhancement for your XD/XDm, made of high-quality adhesive-backed traction tape.**  
X-Treme Grips, XDm 45 (Sand) **O86-15229 \$16.95**  
X-Treme Grips, XDm 9/40 (Sand) **O86-15230 16.95**  
X-Treme Grips, XD 45 (Sand) **O86-15231 14.95**  
X-Treme Grips, XD 9/40 (Sand) **O86-15232 14.95**  
**Powder River Precision's Drop-In Trigger Kits for Springfield XD Pistols will give you a short, crisp trigger pull with a fast reset and shorten the total trigger pull length.**  
XDm 9/40 Drop-In Trigger Kit **O86-15226 \$125.00**  
XDm 45 Drop-In Trigger Kit **O86-15236 125.00**  
XD 9/40 Drop-In Trigger Kit **O86-15228 125.00**  
XD 45 Drop-In Trigger Kit **O86-15227 125.00**  
XD Mod 2 Trigger Kit (4" & 5" only) **O86-33371 125.00**  
XD-S Trigger Spring Kit **O86-15237 \$19.95**  
**Powder River Precision's Ergonomic Punch Set for the XD/XDm made of hardened 416 stainless steel with hard-molded rubber handles designed to fit comfortably in the palm of your hand.**  
XD/XDm Punch Set **O86-15233 \$30.00**  
XD/XDm Striker Retainer Pins **O86-33370 \$12.00**

# Apex Tactical Specialties Parts



**S&W M&P Aluminum Forward-Set Sear & Trigger Kit**  
**O86-77785 \$164.95**  
**S&W M&P Aluminum Flat-Faced, Forward-Set Sear & Trigger Kit**  
**O86-77786 \$169.95**  
**S&W M&P Pistol Sear**  
M&P 9/40 **O86-21889 \$41.95**  
M&P 45 **O86-21892 \$41.95**  
**S&W M&P 9/40 Ultimate Striker Block Kit**  
**O86-21890 \$35.95**  
**S&W M&P 9/40 Competition Spring Kit**  
**O86-21891 \$25.95**  
**S&W SD Polymer Action Enhancement Trigger**  
**O86-77789 \$39.95**  
**S&W SD 9/40 Spring Kit**  
**O86-77787 \$20.95**  
**S&W Sigma Spring Kit**  
**O86-77788 \$20.95**  
**GLOCK Ultimate Safety Plunger**  
**O86-77792 \$17.95**  
**GLOCK Action Enhancement Trigger**  
**O86-77791 \$99.95**

you see a trefoil-shaped anvil staring at you instead of a smooth primer cup.

Finally, primer-wise, take this opportunity to make sure it's been fully seated. If it hasn't, when the firing pin hits the primer, the fact it doesn't have its anvil hard up against the bottom of the primer pocket – instead there's a gap between the two – means the firing pin will actually push the primer forward when it hits it. This absorbs enough impact energy you can have a failure to fire. After dropping the round into the case gage, take a moment to run a finger over the primer, you want to feel it seated actually a bit below the surrounding brass.

You need to understand, in 9mm, there's such a huge variance in the width of case rims, frequently you'll have a round fail to seat fully in the gage, not because there's anything wrong with the over-

all external dimensions of the case body *per se* but simply because the rim is too wide. This doesn't mean the round has failed the gage.

When a loaded round of 9mm goes easily into the gage, but the rim is still butted up against the top of the gage and not entering the hole, that's still a good round. [Editor's note: You can verify this by reversing the round and inserting the rim into the gage. If it fails to enter the gage, the round is still fine.]

The final thing a gage can catch for you is split casings. Fire a casing enough times, expand it through pressure, then work the brass by sizing it back down, eventually it's going to weaken enough it splits longitudinally when seating a bullet during the reloading

process. This results in an oversized "fat" cartridge that won't fit into the chamber, leading to a failure to feed during live fire. When inserting a round with a split casing into a case gage, a very distinctive sort of tactile feedback, and a very distinctive sound, occurs. You can feel it, and you can hear it. The results are kind of hard to describe, but I would say it both feels and sounds "crunchy." Once you've known it, you'll never mistake it for anything else.

You can always tell the inexperienced versus the experienced handloader. The former is the person constantly shucking oversized rounds out of their gun during a match or practice session, as they experience feedway stoppage after feedway stoppage because many of their rounds won't fit into the gun's chamber. These are the people who'll say to you, "I don't see WHY I'd need a case gage." Experienced handloaders are the people to whom that never happens, their guns just run flawlessly, because they own a case gage for every cartridge they load.

Duane's website is [Self-Defense-Handguns.com](http://Self-Defense-Handguns.com). 

the unsupported area of the feed ramp during firing. Standard sizing dies only resize about the top 2/3 of a casing, because we don't want to be working the bottom 1/3, i.e. the area where the web meets the interior case wall; that can stress the brass so much, in a critical area, we could wind up with a case head separation during firing. As anyone who's ever experienced one can tell you, case head separations suck, because you wind up with a circular piece of brass fire-formed to the interior of your gun's chamber that's quite difficult to get out. This is a procedure requiring time, and tools. So, since dies only resize the top 2/3 of casings, it's quite possible to load ammo that has the un-resized bottom of the casing still so "pregnant" it won't fit into the chamber, leading to a failure to feed during live fire.

This phenomenon has, historically, been so associated with casings fired in GLOCKS you'll actually hear it called "GLOCK bulge." The myth is that GLOCKS have "unsupported chambers" to assist in feed reliability. While there may be some truth to this in .40 S&W, it's absolutely untrue in 9mm. Honestly, I think this idea has a lot more to do with 9mm GLOCKS' popularity than their chambers being particularly, in the overall scheme of things, unsupported. 9mm GLOCKS actually have fairly tight chambers. You want to talk guns that have absolutely HUGE chambers: the SIG P220-series in 9mm. You can always tell when you've picked up 9mm brass that was fired in a SIG P225/P226/P228/P229, because it requires WAY more effort on the handle to resize, and "pregnant" rounds, even after all that work on the handle, are quite common.

While some people will say, "You don't need a case gage, just pull the barrel out of your gun and use its chamber to check ammo" the truth is it's a lot easier, and probably cleaner, to use this little piece of stainless steel than having to pull a dirty, oily barrel out of a gun and use it, then reassemble the gun afterward, every time you want to check your handloads.

When you drop a round into the case gage, this gives you a golden opportunity to check the primer. To start with, you can make sure there's actually a primer there. I don't care who you are, and how experienced, the bottom line is we all, occasionally, put together a round without a primer. This is a bad thing, and the case gage allows you to catch that before your gun goes click instead of bang.

Also you can catch those occasional instances where you've accidentally loaded a primer into the primer tube upside-down; when you drop a round into the case gage then visually check it,

**"When you drop a round into the case gage, this gives you a golden opportunity to check the primer. To start with, you can make sure there's actually a primer there."**

# (Case) Gaging Your Own (Ammo's) Worth

By Duane Thomas

If I had to point to one reloading accessory inexperienced handloaders sneer at, and say, "I don't see WHY I need one of those," but experienced handloaders understand is absolutely invaluable, it would be the case gage. (Why it's spelled "gage" instead of "gauge" is beyond me, it just is.) A case gage is a cylinder-shaped piece of stainless steel that's had drilled into it, longitudi-

nally, a hole equivalent to a very tight match chamber for a particular cartridge. After handloading, you use the case gage to check a cartridge's external physical dimensions. If it'll fit into the case gage, it'll fit into a gun's chamber.

One primary thing a case gage can catch, before that cartridge makes its way into your gun and stops it working, is the slight "pregnant" swelling of an autopistol casing that was right over

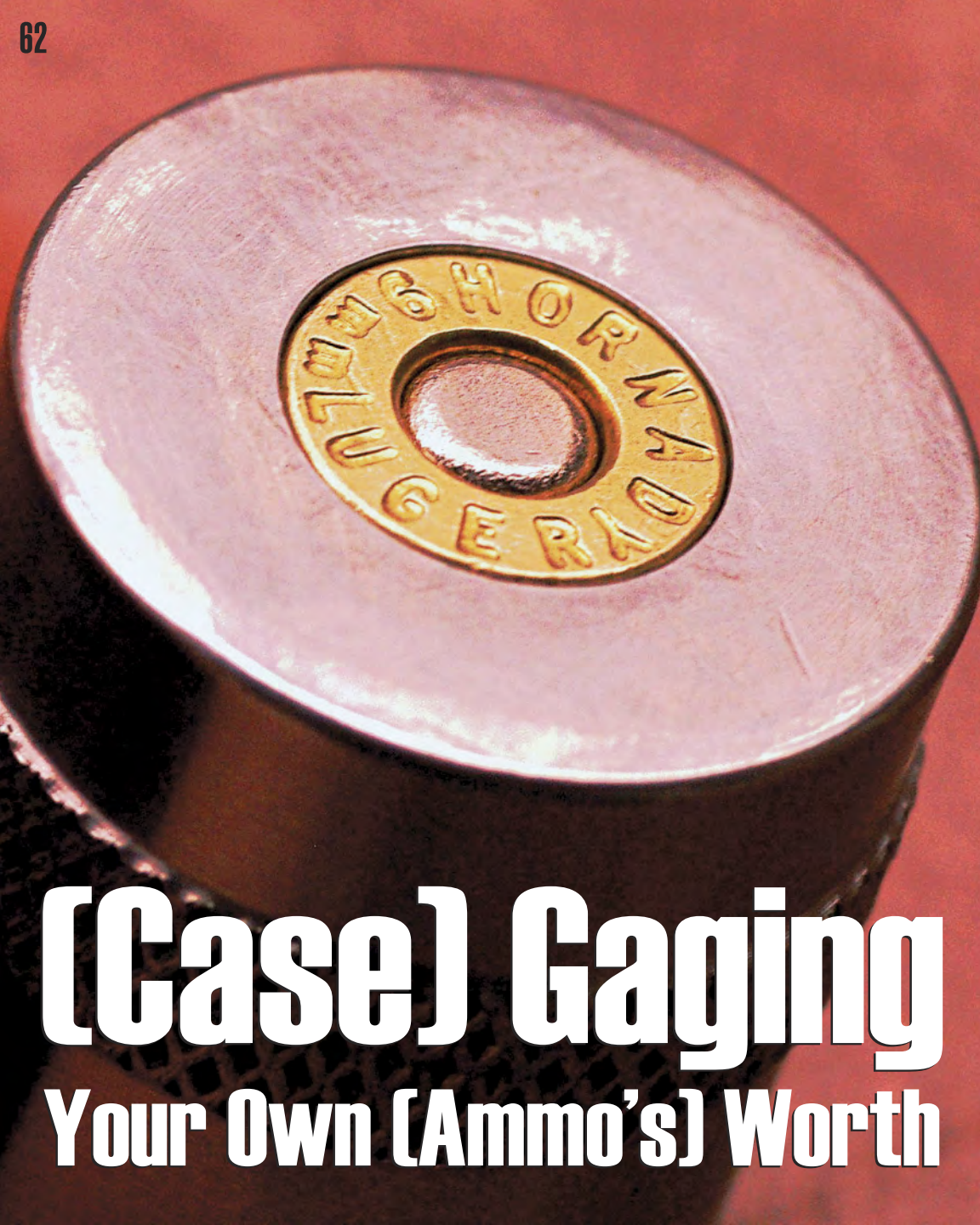



# 64 Dillon Ammunition Boxes<sup>^</sup>

Description	Stock #	Each	10 ea.	Case(Qty.)
9mm (50 rd)	O86-13784	\$1.58	\$13.50	\$58.00(50)
9mm (100 rd)	O86-13645	1.81	15.40	66.00(50)
.38/.357 (50 rd)	O86-13476	1.79	14.70	63.00(50)
.38/.357 (100 rd)	O86-13766	2.20	18.80	80.50(50)
.44 (50 rd)	O86-13568	1.79	15.30	65.50(50)
.44 (100 rd)	O86-13680	2.92	24.90	106.50(50)
.45 ACP (50 rd)	O86-13715	1.73	14.70	63.00(50)
.45 ACP (100 rd)	O86-13574	2.83	24.20	103.50(50)
Small Rifle (50 rd)	O86-13740	2.05	17.50	75.00(50)
Medium Rifle (20 rd)	O86-13625	2.05	17.50	120.00(80)
Medium Rifle (50 rd)	O86-13665	2.90	24.70	106.00(50)
Large Rifle (20 rd)	O86-13647	2.01	17.20	73.50(50)
Large Rifle (50 rd)	O86-13231	3.20	27.30	117.00(50)

NOTE: ".38" series cases fit .38 Super, .32-20, .30 Carbine and .30 Mouser; "9mm" series cases fit .30 Luger, 9 x 21 and .380; ".44" series cases fit .41 Mag, .44-40 and .45 Colt; and ".45" series cases fit 10 mm and .40 S&W. "Small rifle" cases fit .222, .223 to 7.62 x 39 length; 20 round "medium rifle" cases fit 7.62 x 39, .22-250 to .30-06 length; 50 round "medium rifle" cases fit .22-250, .308 to .30-30 length; and "large rifle" cases fit .30-06, 8 x 57 length to all belted cartridges.

Extra Loading Data Labels, O86-10446, Package of 100, \$6.95



Try a few of Dillon's heavy-duty, lightweight plastic ammo boxes. If you're like us, you're tired of crumbling styrofoam and cardboard boxes held together with layers of tape. These boxes are perfect for range or field use. Designed to keep out dirt, dust and rain.

## Dillon AkroBins<sup>^</sup>

AkroBins are ideal for reloaders who load several calibers, bullet weights, bullet shapes, etc. We've been including these bins with our machines for years, and now we're stocking them in quantity for our customers.



- The small bins (the ones we use as Square Deal "B" cartridge bins) are 4-3/4" long x 3-7/16" wide x 2-13/16" deep.
- The RL 550/XL650 cartridge bins are 6-3/4" long x 3-7/16" wide x 2-13/16" deep.

- 7/16" wide x 2-13/16" deep.
- The 1050 bins are 10-1/4" long x 4-3/8" wide x 4-3/4" deep.
- The double-extra-large bins we use on our SL 900 measure 13-3/4" long x 6-1/2" wide x 6-3/4" deep (all inside dimensions).

AkroBins are made of heavy-duty polypropylene with permanent, molded-in color (ours are blue). They're virtually unbreakable; unaffected by weak acids and alkalis, and are also water, rust and corrosion proof. Hang 'em, stack 'em, rack 'em and fill 'em - you just can't beat 'em! Buy several and get your "stuff" together.

Description	Stock #	Each	6 ea.	12 ea.
"Square Deal" Bin	O86-13756	\$2.95	\$15.30	\$24.84
"RL 550/XL 650" Bin	O86-13839	2.95	15.30	24.84
"RL 1050" Bin	O86-13484	6.95	34.92	61.92
"SL 900" Bin	O86-17125	10.50	56.94	106.92

## Dillon Utility Boxes<sup>^</sup>

Dillon's Utility boxes are ideal for all those accessories that don't quite fit into the compartments of your shooting bag. The large box measures 13-1/2" x 5-3/4" x 2-1/4" and the small box measures 4-5/8" x 6-3/8" x 1-5/8". Use them for cleaning gear, extra magazines, repair parts, first aid supplies, reloading accessories and tools - the list is endless.

Description	Stock #	Each	5 ea.
Small Utility Box	O86-13636	\$2.65	\$10.95
Large Utility Box	O86-17195	5.75	23.95



## Berry's Manufacturing Ammo/Storage Boxes<sup>^</sup>

Description	Stock #	Each	10 ea.	50 ea.
.500 S&W (50 rd)	O86-19243	\$2.98	\$22.40	\$97.00
NOTE: .500 S&W Ammo Boxes also fit .223/.243/.308 WSSM				
.454 Casull (50 rd)	O86-19244	2.98	22.40	97.00
.45/70 (50 rd)	O86-19245	3.29	24.20	105.00
7.62 x 54R (50 rd)	O86-19247	3.50	25.50	110.50
.300 Ultra (50 rd)	O86-19246	3.50	25.50	110.50
20 Ga. (25 rd)	O86-19248	2.24	16.80	72.50
12 Ga. (25 rd)	O86-19249	2.24	16.80	72.50
<b>Storage Boxes</b>				
4-3/8" x 2" x 1-5/8"	O86-19250	\$1.12	\$8.40	\$36.50
4-1/2" x 4-1/2" x 1-5/8"	O86-19251	2.32	17.40	75.50
5-1/2" x 2-5/8" x 2-1/2"	O86-19252	2.22	16.70	72.00



# Swab-its - A Swab for Every Job!<sup>65</sup>



No s#!+, there I was...in my office, cleaning my 686 SSR when the boss walks in with that "whisky-tango-foxtrot" look on his face. "Hi," I said (thinking fast), "I'm trying out these Bore-tips before I write the *Blue Press* copy for them. They work GREAT!" The Bore-tips Swabs REALLY DO work. What you can't see under the foam is a plastic jag sized for a tight bore fit which provides for the uniform application of solvents and oils. They work with all standard 8-32 thread cleaning rods, and are tough and reusable.

.22/.56mm (6 ea.)	O86-15310	\$4.98
.243/6mm (6 ea.)	O86-15311	4.98
.30/7.62mm (6 ea.)	O86-15312	4.98
.357/9mm (6 ea.)	O86-15313	4.98
.40/10mm (5 ea.)	O86-15314	4.98
.45 Caliber (5 ea.)	O86-15315	4.98
20 Gauge (3 ea.)	O86-15326	8.98
12 Gauge (3 ea.)	O86-15325	8.98
<b>Multi Pack:</b> (6) .22/.56, (6) .30/7.62, (6) .357/9mm, (5) .40/10mm, (5) .45	O86-43312	26.99



Gun-tips® 3" Precision Tip foam swabs are reusable. 24-count value pack. O86-15345 \$9.99

## Gun-tips®



Gun-tips® Extended Reach Firearm Cleaning swabs by Swab-its® revolutionize the way you clean your gun. The foam tips are lint free, reusable and ideal for cleaning trigger assemblies, slide rails, springs, extractors and anywhere else space is tight. 24 per package. O86-12583 \$9.99

## Bore-Whips™



Bore-Whips™ .17 and .22 caliber (pictured) by Swab-its® are ideal for air rifles, rimfires or any other .17 or .22 caliber firearm that's difficult to clean from the breach. The foam tips are reusable and the handle functions as an empty chamber indicator. .17 Cal. O86-12689 \$9.99. .22 Cal. (Pictured) O86-12690 9.99

## Star Chamber

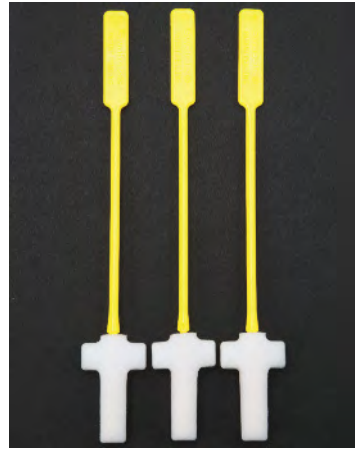

Star Chamber Cleaning Foam Swabs™ are for AR-15, M4 and similar MSRs. 3-pack O86-10056 \$13.99

## Ram Rodz Barrel and Breech Cleaners



The RamRodz® Range Kit comes with 400 Breech Cleaners, 100 .22-Caliber swabs, 60 .38-Caliber swabs, 50 .40-Caliber swabs, 40 .45-Caliber swabs and 30 .50-Caliber swabs. O86-43293 \$34.95



Ram Rodz Barrel & Breech Cleaners	Stock #	Price
.22 Caliber/5.56mm, 300 count	O86-43289	\$12.95
.38 Caliber/9mm, 200 count	O86-43290	12.95
.40 Caliber/10mm, 100 count	O86-43291	12.95
.45 Caliber, 75 count	O86-43292	12.95

**WARNING:** The products offered for sale in this catalog can expose you to chemicals, including BPA's, which are known to the State of California to cause cancer, birth defects or other reproductive harm. For more information, go to [www.P65Warnings.ca.gov](http://www.P65Warnings.ca.gov).

**WARNING:** The products offered for sale in this catalog can expose you to chemicals, including Lead, which are known to the State of California to cause cancer, birth defects or other reproductive harm. For more information, go to [www.P65Warnings.ca.gov](http://www.P65Warnings.ca.gov).

**725 Gun Cleaner Degreaser** should truly be called Super Degreaser. This water-based cleaner will cut through the toughest cosmoline, carbon, grease and grime! Its super strength allows it to degum and degunk the dirtiest of gun parts when sprayed on or used in parts washers or solvent tanks!

**NOTE:** To help prevent rusting, users must apply a gun lubricant immediately after cleaning to disperse any moisture in parts.

16 Oz. O86-19237 \$19.95

**Slip 2000 Carbon Killer** provides you with a safe, effective way to clean carbon, lead and plastic wad fouling. Unlike other gun cleaners, this product is non-flammable, non-hazardous and biodegradable. Designed for soaking metal parts with baked on carbon, Carbon Killer dissolves carbon and lead on contact.

**NOTE:** Carbon Killer is for cleaning internal metal gun parts with baked on carbon by soaking them. It is an aggressive cleaner and should not be used to clean the outside of your gun. It can damage and even remove some finishes.

16 Oz. O86-19234 \$19.95

**Slip 2000 Extreme Weapons Lubricant (EWL)** was designed for use on chain guns and machine guns like the MP5 and the 249SAW. It contains a proprietary Anti-wear agent that reduces friction and wear by 90-95 percent. It is an excellent CLP and is able to clean, lubricate and protect.

4 Oz. O86-11644 \$16.95

**Slip 2000 EWL30** has the same properties as EWL, except it is a lot thicker. It contains a proprietary thickening agent that makes this lubricant consistency like a 30-weight motor oil. It was designed for those who want or need a lubricant that will not migrate at all and don't want to use a thick grease.

4 Oz. O86-11645 \$19.95



Slip 2000's **Extreme Cleaning System** contains 2 Oz. bottles of: Carbon Killer Bore Cleaner, 725 Gun Cleaner Degreaser, and EWL Extreme Weapons Lubricant.

O86-11652 \$22.95



Slip 2000's **AR Cleaning System** contains a 7 Oz. bottle of Carbon Killer Bore Cleaner, a 15cc syringe of Extreme Weapons Grease, and a 1 Oz. bottle of EWL Extreme Weapons Lubricant.

O86-11676 \$18.95

**Slip 2000 Copper Cutter** is specially formulated to remove copper, lead, powder residue and plastic wad fouling from bore surfaces with little scrubbing!

**NOTE:** It is a water based, ammonia enhanced product and will remove all lubrication or oil protection, so always re-lube all parts cleaned.

4 Oz. O86-11646 \$10.95

Each Slip 2000 **Gun Wipe** packet contains one 5" x 8" wipe treated with Slip 2000 Synthetic Gun Lube. Perfect for wiping your guns down after a day on the range or while out on a hunt. Apply to all metal surfaces. Great for light carbon cleaning. Safe for all firearm stocks and grips.

20 Pack O86-11674 \$11.95



**DEWEY Nylon Coated Cleaning Rods**

- All Caliber Pistol 6" O86-15461 \$19.95
- (.22-.26 Jag Adapter for All Caliber 6" rod) O86-19894 3.25
- (.27 & up Adapter for All Caliber 6" rod) O86-19895 3.25
- .22-.26 Caliber Pistol 12" O86-12985 23.95
- .17 Caliber Rifle 26" O86-11472 22.95
- .17 Caliber Rifle 36" O86-11473 25.95
- .22-.26 Caliber Rifle 36" O86-13084 26.95
- .22-.26 Caliber Rifle 44" O86-15462 25.95
- (.22-.26 Jag Adapter for Rifle rod) O86-14542 2.25
- .27 Caliber and up Pistol 12" O86-13021 23.95
- .27 Caliber and up Rifle 36" O86-12991 24.95
- .27 Caliber and up Rifle 44" O86-15463 25.95
- .35 Caliber and up Rifle 36" O86-17096 29.95
- .35 Caliber and up Rifle 44" O86-17097 29.95
- (.27 & up Adapter for Rifle rod) O86-14541 2.25
- Shotgun Rod (Uncoated Brass) O86-10473 24.95
- 2-pc Shotgun Rod O86-15464 31.99
- Brass Jags** (Note: These jags ONLY fit Dewey Cleaning Rods!)
  - .22 Caliber Brass Jag O86-10026 \$2.99
  - .24 Caliber Brass Jag O86-10027 2.99
  - .27 Caliber Brass Jag O86-10025 2.99
  - .30 Caliber (and up) Brass Jag O86-10867 2.99
  - .38 - .41 Cal. Brass Jag O86-10028 2.99
  - .44 - .45 Cal. Brass Jag O86-10243 2.99
- Brass Patch Loop**
  - Accepts most pistol and rifle patches O86-10737 \$2.25
- .17 Caliber Bore Brushes**
  - .17 Caliber Rifle/Nylon (ea.) O86-11475 \$1.95
  - .17 Caliber Rifle/Bronze (ea.) O86-11474 1.95
- Nylon Bore Brushes**
  - .22 Caliber Rifle (ea.) O86-16144 \$1.95
  - .243 Caliber Rifle (ea.) O86-16145 1.95
  - .270 Caliber Rifle (ea.) O86-16146 1.95
  - .30 Caliber Rifle (ea.) O86-16147 1.95
  - .22 Caliber Pistol (ea.) O86-16302 1.95
  - .38 Caliber Pistol (ea.) O86-16148 1.95
  - .40 Caliber Pistol (ea.) O86-16149 1.95
  - .45 Caliber Pistol (ea.) O86-16150 1.95

- Bronze Bore Brushes**
  - .22 Caliber Rifle O86-16278 \$1.50
  - .25 Caliber Rifle O86-16293 \$1.50
  - .243 Caliber Rifle O86-16280 \$1.50
  - .270 Caliber Rifle O86-16274 \$1.50
  - .30 Caliber-7.62mm Rifle O86-16273 \$1.50
  - .35 Caliber Rifle O86-16281 \$1.50
  - .44-.45 Caliber Rifle O86-16279 \$1.50
  - .22 Caliber Pistol O86-16282 \$1.50
  - .38 Caliber-9mm Pistol O86-16275 \$1.50
  - .40-.41 Caliber-10mm Pistol O86-16276 \$1.50
  - .44-.45 Caliber Pistol O86-16277 \$1.50
- 5 pack/\$5.50
  - O86-22089
  - O86-22094
  - O86-22091
  - O86-22085
  - O86-22084
  - O86-22092
  - O86-22090
  - O86-22093
  - O86-22086
  - O86-22087
  - O86-22088

- Cotton Mops**
  - .22-.27 Caliber (ea.) O86-17089 \$1.95
  - .30-.38 Caliber (ea.) O86-17090 1.95
  - .400-.450 Caliber (ea.) O86-17091 1.95
  - 16, 12 & 10 Ga. Shotgun (ea.) O86-17094 1.95
- M-16/AR-15 Breech Rod Guide/Chamber Brush**
  - Breech Rod Guide O86-10149 \$20.00
  - AR-15 Chamber Cleaning Brush O86-11299 \$35.00
- Deluxe M-16/AR-15 Lug Recess Cleaning Kit**
  - Lug Recess Cleaning Kit O86-18533 \$27.95

*Includes: Chamber Cleaning Rod, Lug Recess Cleaning Head, Delrin Guide Sleeve, 50-pak Cotton Cleaning Rolls, Chamber Brush, Chamber Mop, Double-Ended Nylon Cleaning Brush.*

- Bolt Action Rifle Cleaning Rod Guides**
  - All models fit .695-.700 bolt diameter rifles.
  - .17-.222, .225, .22/250, .220 Swift O86-14196 \$18.95
  - .243 Caliber - 7mm O86-14197 18.95
  - .30 Caliber O86-14198 18.95
  - .338 Caliber O86-14199 18.95

- Muzzle Guards**
  - AR-15/M-16 O86-16875 \$10.95
  - M1-A/M-14 O86-16876 10.95
  - M1 Garand O86-16878 10.95
  - Ruger 10-22 Standard Bbl. O86-16877 10.95
  - Ruger 10-22 Bull Barrel O86-16879 10.95
  - Brass Muzzle Guard, .30 Cal. O86-17245 10.95

- Nylon Gun Parts Cleaning Brush**
  - Parts cleaning brush O86-16389 \$2.25
- Cleaning Patches**
  - Packages of 1000
    - .17 cal. O86-11807 \$12.95
    - .22-.24 O86-11808 14.95
  - Packages of 500
    - .24-.27 O86-11809 \$11.95
    - .30-.35 O86-11810 13.95
  - Packages of 250
    - .38-.45 O86-11811 \$11.95

**Lyman Pick & Brush Set**



Lyman's Pick & Brush Set is an indispensable item for your cleaning supplies and range bag. O86-40160 \$3.99

**MIL-COMM**  
Extreme Performance Lubricants

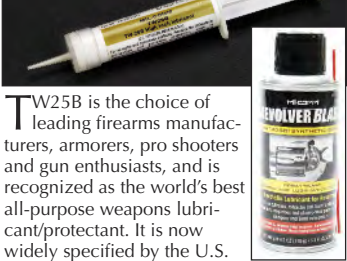

TW25B is the choice of leading firearms manufacturers, armorers, pro shooters and gun enthusiasts, and is recognized as the world's best all-purpose weapons lubricant/protectant. It is now widely specified by the U.S. military for their most critical performance weapons systems. Environmentally safe, non-carcinogenic, non-ozone-depleting. 0.5 Oz. Syringe O86-15732 \$10.99. 1.5 Ounces O86-15731 14.50. Rsynolver BLAST with TW25B is an all-synthetic lubricant/protectant specifically designed for revolvers. 4.2 Oz. Aerosol O86-66677 \$11.95

**E-Z Brite Wonder Cloth**



On gun dealers shelves since 1976, this product is still a must for keeping stainless steel and nickel-finished revolvers looking like new. Demand the original lead and carbon wipe! E-Z Brite Cloth O86-18613 \$7.99



Brian Enos' Far Superior Slide-Glide is a dual grease blend, with proprietary extreme pressure compounds, which boost the ability of the oils in the grease to withstand extreme pressures. It gives the grease a very stringy, tenacious character that makes it stay where you put it. Slide-Glide Standard is for use in warm weather (F60+), Lite is a thinner viscosity for lower temperatures (F30+). Slide-Glide Standard O86-15571 \$7.95. Slide-Glide Lite O86-15572 7.95



Microton UltraBlue protects, penetrates and lubricates all surfaces. UltraBlue is in use by the US Army Marksmanship Training Unit, the US Army Pistol and Rifle Teams and the US Marine Corps Pistol and Rifle Teams. O86-75125 \$9.95

Sweet's Australian 7.62 Solvent easily removes powder residue and stubborn copper fouling. It's harmless to steel, a non-acid formula with five percent ammonia. If you shoot a rifle, you ought to try cleaning it with Sweet's. O86-13128 \$12.95



**WARNING:** The products offered for sale in this catalog can expose you to chemicals, including Lead, which are known to the State of California to cause cancer, birth defects or other reproductive harm. For more information, go to www.P65Warnings.ca.gov.

WILSON COMBAT

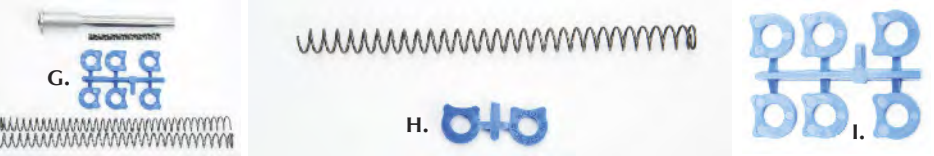

**Wilson Combat's Elite Tactical Magazine HD +P** – "The ETM Heavy Duty/+P rated .45 ACP magazines with exclusive stainless flatwire MAX magazine spring and time-tested ETM tube."  
**A.** (8 rd) .45ACP **O86-18602 \$44.95**  
**Elite Tactical Magazine** – "The ETM started with a blank sheet of paper and 30-plus years of 1911 and 1911-magazine experience; designed from the ground up as a premium tactical magazine."  
**B.** ETM (8 rd) .45ACP **O86-12027 \$34.95**  
**C.** ETM (10 rd) 9mm **O86-19463 \$34.95**  
**Wilson Combat Magazines** – "No other .45 magazine on the market can compare for proven inherent reliability, durability and the ability to remain fully loaded for long periods of time without damage."  
**D.** Match Magazine (7 rd) .45ACP **O86-10505 \$32.95**

**E.** WIL-ROG Mag (8 rd) .45ACP **O86-11714 \$32.95**  
**F.** Officers Match Mag. (7 rd) .45ACP **O86-10506 \$32.95**  
**SHOK-BUFF® Recoil System** – Includes a One Piece Guide Rod and Plug; six SHOK-BUFF buffers; an Extra Power Firing Pin Spring; an Extra Power Recoil Spring; and a Reduced Power Recoil Spring.  
**G.** SHOK-BUFF System **O86-18150 \$37.05**  
**Wilson SHOK-BUFF®** – A 1/10" thick poly fiber buffer between the frame and slide contact areas.  
**H.** SHOK-BUFF Kit (2 buffers, 18.5# recoil spring) Gov't Model **O86-18148 \$5.95**  
**I.** SHOK-BUFF Buffer only (6 ea.) **O86-18147 \$6.95**

WOLFF GUNSPRINGS

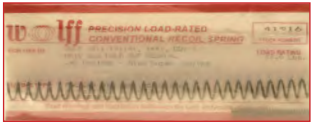

**Wolff RECOIL SPRINGS**  
**BROWNING HI-POWER**  
 18.5 Pound **O86-11373 \$7.25**  
**COLT GOVERNMENT MODEL**  
 9 Pound **O86-11719 \$7.25**  
 10 Pound **O86-12193 7.25**  
 12 Pound **O86-12007 7.25**  
 13 Pound **O86-12443 7.25**  
 14 Pound **O86-12338 7.25**  
 16 Pound (Std.) **O86-11860 7.25**  
 17 Pound **O86-12192 7.25**  
 18.5 Pound **O86-12465 7.25**  
 20 Pound **O86-12056 7.25**

23 Pound **O86-11377 7.25**  
**COLT OFFICERS MODEL**  
 24 Pound **O86-12110 \$7.25**  
**CZ 75B**  
 9 Pound **O86-19348 \$7.98**  
 10 Pound **O86-19349 7.98**  
 11 Pound **O86-19350 7.98**  
 12 Pound **O86-19351 7.98**  
 13 Pound **O86-19352 7.98**  
 14 Pound (Std.) **O86-19353 7.98**  
**SMITH & WESSON M&P**  
 12 Pound **O86-19356 \$7.98**  
 14 Pound **O86-19357 7.98**  
 15 Pound **O86-19358 7.98**  
 16 Pound (Std.) **O86-19359 7.98**  
**SPRINGFIELD 5" 9/40 XD**  
 12 Pound **O86-19339 \$7.98**  
 13 Pound **O86-19340 7.98**  
 14 Pound **O86-19341 7.98**  
 15 Pound **O86-19342 7.98**  
 16 Pound **O86-19343 7.98**  
 17 Pound (Std.) **O86-19344 7.98**  
**SPRINGFIELD 5" 45 XD**  
 14 Pound **O86-19345 \$7.98**  
 16 Pound **O86-19346 7.98**  
 18 Pound **O86-19347 7.98**  
**SPRINGFIELD 4.5" 9/40 XDM**  
 14 Pound **O86-19336 \$7.98**  
 16 Pound **O86-19337 7.98**  
 18 Pound (Std.) **O86-19338 7.98**  
**Wolff GUIDE RODS**  
 S&W M&P **O86-19354 \$24.95**  
 Sp'field XDM 4.5 **O86-19355 24.95**  
**Wolff HAMMER SPRINGS**  
 1911 **O86-11511 \$9.00**  
**Wolff MAG CATCH SPRINGS**  
 1911 **O86-11791 \$9.95**

SPRINGFIELD Magazines/1911 Guide Rod



**Springfield XD & XDM Magazines**  
 16-Rd. XD 9mm **O86-11586 \$31.95**  
 12-Rd. XD .40 **O86-11587 31.95**  
 13-Rd. XD Comp. 9mm **O86-11765 29.95**  
 9-Rd. XD Comp. .45 **O86-11764 29.95**  
 13-Rd. XD/XDM .45 **O86-11585 32.95**  
 19-Rd. XDM 9mm **O86-15496 36.95**  
 7-Rd. XD-S 9mm **O86-19681 28.95**  
 8-Rd. XD-S 9mm **O86-11731 39.95**  
 9-Rd. XD-S 9mm **O86-19680 39.95**  
 16-Rd. XDM .40 **O86-19971 36.95**  
 5-Rd. XD-S .45 **O86-15234 28.95**  
 6-Rd. XD-S .45 **O86-11730 39.95**  
 7-Rd. XD-S .45 **O86-15235 39.95**  
**Two-Piece 1911 Recoil Spring Guide Rod** – Machined from stainless steel.  
**O86-15724 \$24.95**

**ADCO SUPER THUMB®**  
 Offers models for popular centerfire pistols and 10/22 style magazines.  
**ST1** is for 9mm and .40 caliber Beretta, Browning, Ruger, SIGARMS, S&W, etc. In addition, the ST1 has interior rails and grooves to accommodate Colt Government magazines.  
**O86-18607 \$10.95**  
**ST2** is for GLOCK and Para-Ordnance magazines.  
**O86-18608 \$10.95**  
**ST3** handles virtually all centerfire, single-column magazines.  
**O86-18609 \$10.95**  
**ST22** is for Ruger 10/22 rifles.  
**O86-18610 \$10.95**  
**STJR** is for Ruger, Browning, Colt and High Standard .22 pistols.  
**O86-18611 \$3.50**



Mec-Gar Pistol Magazines

**NEW Plus-2 Adapter, fits mags in red Beretta 92 18-rd. AFC\*** **O86-62207 \$9.95**  
**O86-18728 25.95**  
**Beretta 92 20-rd. AFC\*** **O86-18729 29.95**  
**O86-18730 25.95**  
 Browning HP 15-rd. Blue **O86-43406 25.95**  
 1911 8-rd. .45 ACP Blue **O86-43405 24.95**  
 1911 8-rd. .40 S&W Blue **O86-43404 24.95**  
 1911 8-rd. 10mm Blue **O86-43403 24.95**  
 1911 9-rd. 9mm Blue **O86-43402 29.95**  
 1911 10-rd. 9mm Blue **O86-18732 24.95**  
 1911 11-rd. .45 ACP Blue **O86-14989 29.95**  
**CZ-75B 19-rd. AFC\*** **O86-18733 23.95**  
 Para P-14 14-rd. Blue **O86-18734 23.95**  
 Para P-16 15-rd. Blue **O86-18735 23.95**  
 Para P-18 17-rd. Blue **O86-18736 25.95**  
 Ruger P-Series 9mm 17-rd. Blue **O86-18737 29.95**  
 Ruger P-Series 9mm 20-rd. Blue **O86-18738 25.95**  
 S&W 59 17-rd. Blue **O86-18739 29.95**  
 S&W 59 20-rd. Blue **O86-18740 25.95**  
**SIG Sauer 226 18-rd. AFC\*** **O86-18741 25.95**  
 SIG Sauer 228 15-rd. Blue **O86-14988 23.99**  
 Springfield XD (not XDM) 9mm 18-rd. **O86-14991 29.95**  
 Springfield XD (not XDM) .40 13-rd. AFC\* **O86-18742 25.95**  
**Taurus 92-99 17-rd. Blue** **O86-18743 29.95**  
**Taurus 92-99 20-rd. Blue**  
**\*AFC = Anti-Friction Coating**

CMC Mags

**McCormick Railed Power Mags™** feature patent pending Dual Wall Feed Rails™ that are at least twice the strength of regular feed lips. They have a patented tactical RPM™ follower, a stainless steel mag tube, an EZ clean base pad and a proven customer-satisfaction policy. All CMC magazines are designed to give the pistol shooter the advantage of extra shot capacity and improved performance.



**Railed Power Mags™**  
 CMC RPM 10-Rd. .45 ACP 1911 **O86-11077 \$39.95**  
 CMC RPM 8-Rd. .45 ACP 1911 **O86-11078 36.95**  
**XP Series, Match Grade and Power Mag+ Magazines**  
 XP-9 10-Rd. 9mm **O86-43261 \$39.99**  
 Extra XP-9 Base Pad **O86-43300 \$4.99**  
 Match Grade .45 ACP 8-Rd. (Floorplate drilled for base pads.) **O86-10311 30.99**  
 Power Mag+.45 ACP 10-Rd. **O86-15025 34.99**

Arredondo Accessories Mag-Cleaning Brush



Arredondo Accessories' Magazine-Cleaning Brush is ideal for that little job we all dread (avoid!)! No excuse, Sir!  
**O86-19257 \$11.95**

ARCHANGEL® Lever Release SKS Magazines



Archangel's OPFOR® SKS magazines feature a revolutionary steel lever release and positive grip texture for quick and easy magazine changes. A game changer – the oversized thumb lever is ergonomically located and easy to press, enabling you to perform a fast, one-handed reload on your SKS rifle. Available in 20- and 35-round capacities.  
 35-Round Mag. **O86-13012 \$29.95**  
 20-Round Mag. **O86-13088 29.95**



**Metalform 8-Round 10mm 1911 pistol magazine.**  
**O86-33328 \$24.95**



**C-Products 30-Round Aluminum M-16/AR-15 magazine.**  
**O86-15593 \$19.95**



**9mm M-16/AR-15 magazines. Metalform (20-Rd.) & C-Products (32-Rd.).**  
 20-Rd. **O86-44504 \$34.95**  
 32-Rd. **O86-49996 29.95**



**Field Knife, Glock, with scabbard, 1 ea.**  
**O86-15483 \$34.95**

70 ELITE TACTICAL SYSTEMS MAGS & LOADERS



**E**lite Tactical Systems' C.A.M. Rifle Magazine Loader loads AR15, AK47, AK74, FN SCAR-16/17, AR10, G36, Steyr AUG, MP5, CZ Scorpion EVO, Colt SMG, UZI and more in 5.56x45/.223, 7.62x51/.308, 7.62x39, .300BLK, 5.45x39, 9mm and more.

The ETS C.A.M. Pistol Magazine Loader loads most 9mm or .40 caliber pistol magazines – including single stacks. It doesn't force rounds through the feed lips, so it won't damage magazines.

Both ETS C.A.M. magazine loaders will lift up to 10 rounds of ammo directly from an ammo tray!

ETS 30-round AR magazines have a built-in coupler that allows multiple magazines to be connected in seconds with no tools. Clip-on dust covers keep dirt and debris out during storage.

ETS magazines for GLOCK® pistols are compatible with aftermarket floorplates for Glock magazines, feature

special grip ribs on the floorplate to aid in extraction and are easy to disassemble for cleaning and maintenance.

**Made in USA With a Lifetime Warranty!**

A. C.A.M. Rifle Mag. Loader	<b>O86-10244</b>	<b>\$29.99</b>
B. C.A.M. Pistol Mag. Loader	<b>O86-10245</b>	<b>29.99</b>
C. AR Magazine, 30 rd.	<b>O86-10266</b>	<b>19.99</b>
D. GLK-18 Magazine, 31 rd. 9mm	<b>O86-10246</b>	<b>21.99</b>
GLK-17-10 Magazine, 10 rd. 9mm	<b>O86-10265</b>	<b>17.99</b>
GLK-19-10 Magazine, 10 rd. 9mm	<b>O86-10264</b>	<b>17.99</b>
GLK-22 Magazine, 30 rd. .40 S&W	<b>O86-10250</b>	<b>21.99</b>
GLK-42 Magazine, 7 rd. .380	<b>O86-10251</b>	<b>16.99</b>
GLK-42 Magazine, 9 rd. .380	<b>O86-10260</b>	<b>21.99</b>
GLK-42 Magazine, 12 rd. .380	<b>O86-10261</b>	<b>21.99</b>
GLK-43 Magazine, 7 rd. 9mm	<b>O86-10247</b>	<b>16.99</b>
GLK-43 Magazine, 9 rd. 9mm	<b>O86-10248</b>	<b>21.99</b>
GLK-43 Magazine, 12 rd. 9mm	<b>O86-10249</b>	<b>21.99</b>

**Specialized Dynamics Armorer's Upper Receiver Block**

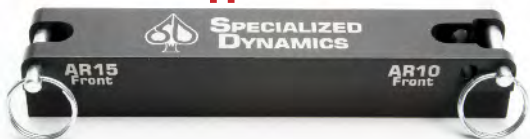

The **Specialized Dynamics AR15/AR10 Armorer's Upper Receiver Block** is made from billet aluminum and holds your upper receiver securely in order to make it easier to install barrels, free-float tubes, muzzle devices, etc. One block fits AR15s and ArmaLite and DPMS platform AR10s. (Sorry, the upper receiver pictured above is NOT included.)

**O86-43234 \$59.99**

**Arredondo Multi-Function Squib Rod**



This is a **MUST-HAVE** range-bag accessory. It's a squib rod (for removing stuck bullets), magazine base removal tool, and scope windage adjustment and battery cap removal tool.

**O86-15250 \$12.95**

**The Larry™ Pocket Work Light**

The **Larry™ 8 LED Pocket Work Light** is the essential handyman light. 8 powerful LEDs provide 60 lumens of bright white light. The rotating magnetic clip gives you convenient hands-free lighting. The reinforced plastic body design is shock-proof and water-resistant, making the Larry™ basically indestructible.

**O86-15432 \$9.99**

**Poppy™** – A combination 300 Lumen C•O•B lantern and 120 Lumen LED spot light. Poppy is the ideal light for indoor or outdoor use when versatility and powerful lighting are critical. Poppy easily changes from spot light to lantern with just a slide of its top, revealing a full 360° C•O•B lantern. The handle is designed to easily adjust to serve both light modes. *Note: Assorted colors, no color selection.*

**O86-00116**

**SnapSafe Modular Vaults LOCKBOX** 71



The SnapSafe® Modular Vaults **LOCKBOX** is a pry-resistant 16 gauge steel container that provides secure storage for handguns and other valuables. Meets TSA airline firearm guidelines.

Dimensions: 9.5" x 6.5" x 1.75".

**O86-01044 \$19.95**

**SnapSafe® Pistol Racks**

Store guns in your safe or display them anywhere with these handy gun racks made in four different widths. The rack helps maximize storage space while offering a secure and balanced rack designed for compact pistols, full-size handguns, revolvers and semiautos. Their PVC coating prevents scratches or marring. Store guns right side up or upside down, depending on your preference.

<b>Two-gun Rack measures 4.5" x 7" x 5.75"</b>	<b>O86-33127</b>	<b>\$8.00</b>
<b>Four-gun Rack measures 9" x 7" x 5.75"</b>	<b>O86-33128</b>	<b>10.00</b>
<b>Six-gun Rack measures 13.5" x 7" x 5.75"</b>	<b>O86-33129</b>	<b>12.00</b>
<b>Eight-gun Rack measures 18" x 7" x 5.75"</b>	<b>O86-33130</b>	<b>15.00</b>



**SnapSafe's 30 LED Cordless Motion Sensor Light** is ideal for large gun safes. 25.75" x 0.7" x 0.6"

**O86-10019 \$25.99**

**SnapSafe's 20 LED Cordless Motion Sensor Light** is ideal for small-to-medium gun safes. 13" x 0.7" x 0.6"

**O86-10018 \$20.99**

**SnapSafe's Vehicle Headrest Gun Rack** secures long guns behind headrest and doubles as storage for range bags, etc. Coated wire won't mar firearms.

**O86-10020 \$7.99**

# 72 KNS Precision, Inc. AR ACCESSORIES



KNS Precision, Inc. AR-15 Bolt Catch Retainer Pin.  
O86-33390 \$9.00

Perma-Pin Firing Pin Retainer for M-16 and AR-15 replaces the standard cotter pin found in the bolt carrier to retain the firing pin (as in original Stoner rifles). Made of tool steel. No modification to gun required.  
O86-19927 \$9.00



Gen 2 Mod 2 Non-Rotating Trigger/Hammer Pins .154 Diameter.  
O86-33391 \$33.00



Gen ST Non-Rotating Trigger/Hammer Pins .154 Diameter.  
O86-33392 \$38.00

## AR-15 Bolt & Carrier



O86-19662 \$99.95

## KNS Precision, Inc. AK ADJUSTABLE GAS PISTON SYSTEM



- Reduce recoil and improve accuracy
- Tune any AK for optimum suppressed use
- Shoot a wider range of ammunition types
- Reduce operating noise and "port pop"
- Decrease cyclic rate for automatic fire
- US-manufactured part for 922r compliance

O86-33405 \$149.00



So THAT's how you grease that little S.S.O.B. (Slick-Operating Bolt, that is.) M-14/M1A Bolt Roller Greaser  
O86-18531 \$6.75

## Adjustable M1/M1A Gas Systems



All Schuster Mfg. Inc. adjustable gas plugs are made in the U.S.A. from hardened tool steel, Parkerized and feature a lifetime factory warranty. By adjusting the volume of gas, you change the speed of the op rod and the barrel harmonics. If you're working up your own handloads, a quarter of a turn WILL affect your group size. Includes instructions and the adjustment tool (Allen wrench).  
M1A (Picture) O86-15405 \$59.00  
SOCOM M1A O86-15409 59.00  
M1 Garand O86-15408 40.00

## Taylor Freelance Magazine Extensions



**Taylor Freelance Magazine Extensions**  
AR-15/Tavor 9mm SMG +10 O86-12377 \$39.95  
This extension adds a full 10 rounds to your 32-round Colt SMG-type magazine. Works with many "stock" mag springs.  
NOTE: Colt SMG mags come from many different manufacturers. Colt offered at least two major types - one where the floorplate slides on from the front, and the other which slides on from the rear. TF extensions are built to work with BOTH the front-mount and rear-mount styles.  
CZ Skorpion +10 O86-12378 \$49.95  
• Extra length/strength spring included

• Thumbscrew-and-gasket retention system allows for quick, easy disassembly.  
GLOCK +10 O86-12379 \$59.95  
Transforms Glock 31-round magazines into 41+1 round mags.  
• Extra length/strength spring included.  
SIG MPX +10 O86-12376 \$29.95  
• Works with stock mag spring.  
• Angled floor stands the magazine straight up on a table for easier loading.  
SIG P320 +5 O86-12375 \$39.95  
• Extra length/strength spring included.

800-223-4570 or 480-948-8009 • FAX 480-998-2786 • 24-Hour On-Line Ordering @ [www.bluepress.com](http://www.bluepress.com)

# MAGPUL® UNFAIR ADVANTAGE™ 73



MAGPUL 30-Round polymer PMAG 30 GEN M3™ AR-15/M4 .223/5.56 magazine.  
O86-43280 \$14.95

## Enhanced Self-Leveling AR-15/M16 Mag Follower



MAGPUL's Enhanced Self-Leveling Follower is a drop-in replacement for USGI 30-round magazines. Features a four-way anti-tilt design.  
3-Pk. O86-12606 \$6.95



MAGPUL 1911 Grip Panels feature reinforced polymer construction and a unique diamond-shaped cross section to prevent twisting in the hand. They also have an aggressive mag-release cut out and are compatible with ambidextrous safeties.  
Flat Dark Earth O86-43237 \$19.95  
Black O86-43236 19.95  
Olive Drab Green O86-43238 19.95

## MAGPUL MAGLINK™



O86-43240 \$17.95



FOR MAGPUL .223/5.56 MAGS ONLY

## MAGPUL QD SLING SWIVEL



O86-43239 \$14.95



MAGPUL 30-Round polymer PMAG 30 AK/AKM MOE® 7.62x39 magazine.  
O86-43241 \$13.95



MAGPUL 25-Round polymer PMAG 25 LR/SR Gen M3™ Window SR25/M110 .308/7.62x51 magazine.  
O86-27080 \$22.95



MAGPUL 10-Round polymer PMAG 10 AR-15/M4 Gen M3™ .223/5.56 magazine.  
O86-33393 \$13.95



MAGPUL 20-Round polymer PMAG 20 AK/AKM MOE® 7.62x39 magazine.  
O86-10008 \$12.95



MAGPUL 20-Round polymer PMAG 20 LR/SR Gen M3™ SR25/M110 .308/7.62x51 magazine.  
O86-55007 \$19.95



MAGPUL -5 Round Limiter PMAG 20. Only fits .223/5.56 magazines.  
O86-33394 \$13.95 Pkg of 3

**WARNING:** The products offered for sale in this catalog can expose you to chemicals, including Lead, which are known to the State of California to cause cancer, birth defects or other reproductive harm. For more information, go to [www.P65Warnings.ca.gov](http://www.P65Warnings.ca.gov).

# 74 "The Perfect Small Parts Cleaning Accessory"



The HYSKORE Degreezer consists of a 12" x 6" x 4-1/2" polypropylene tray with an angled drainage surface and a well with a perforated basket for holding and draining small parts. The set also includes a standard double-end nylon gun-cleaning brush. As anyone who has cleaned a gun is aware, cleaning small parts is a major challenge. Given the available technology and fixtures, the standard procedure is to use some kind of cup or similar vessel, pour in a quantity of cleaning solvent, and then pick up the parts one by one and brush them clean. The Degreezer changes all of that. Small parts and even complete trigger groups and bolt assemblies can be placed in the basket and the well filled with solvent to cover the parts and left to soak for extended periods. Then the basket can be withdrawn, draining all the parts. As a bonus, the set includes a cover with an integral holder for the brush. This means the solvent that has been contaminated by the cleaning process can be left in the well of the Degreezer (rather than returned to the bottle) with the cover in place so that it's ready to be used for the next cleaning event. The tray, cover, and basket are made from polypropylene plastic. This has been proven to be impervious to all popular commercial cleaning solutions. It will also resist kerosene, acetone, and gasoline. The Degreezer will quickly become an indispensable fixture on your workbench.

086-10209 \$15.95

# HYSKORE Six-Gun Modular Pistol Rack

The HYSKORE Six Gun Modular Pistol Rack is constructed from closed-cell, non-reactive foam that will not absorb moisture or react with lubricants or solvents. It has a soft, suede-like finish, but is rigid enough to offer firm support. The rest will hold six pistols with either single-stack or double-stack magazines, and can be disassembled and reconfigured to hold guns with wider or narrower grips. The modular feature of the rest also means that two or more rests can be connected together and reconfigured not only to give each gun its own "special home," but also to take maximum advantage of all available space in your safe or vault. This is easy to do using 3/16" threaded rod, washers, and hex nuts available from any home-improvement store. The rack measures 11-1/4" wide x 7-1/2" deep x 6" high.



086-10208 \$19.99

# 5.11 Tactical All Hazards Ammo Mule

Sometimes, you just need more ammo. The All Hazards Ammo Mule is light-weight, durable and weather resistant. It features a secure wraparound zipper with a molded pull and measures 10.12" wide x 3.88" deep x 8" high. It'll hold 10 5.56 AR mags or six 25-rd. boxes of shotgun shells.



086-19661 \$27.99

# OPSol Mini-Clip™

Allows the use of 12 Ga. 1.75" Birdshot, Buckshot and Slug shells. Fits 12 Ga. Mossberg 500, 590, 590A1 and Maverick 88 models

The OPSol Mini-Clip™ was designed to give "well seasoned" and "recoil sensitive" shooters the capability of shooting the trusty Mossberg 12 Ga. platform without the usual recoil response. By using The OPSol Mini-Clip™ in conjunction with 1.75" shotgun shells, shooters stay in the game without all of the pain. The Mini-Clip enables owners of Mossberg 12 Ga. shotguns to use Aguila Minishells reliably for training, practice, recreational or home-defense applications.



086-10471 \$14.99

# JP Enterprises, Inc. Tactical Performance Gear



JP Enterprises (Competition Only) Low Mass Buffer JPLMB  
086-12585 \$59.95



Custom Stainless Bolt Carrier  
JPFBC-3 SP Low Mass, Stainless Finish  
086-12584 \$225.95



JPFC-1 .154 Small Pin  
Fire Control Kit w/CD-ROM  
Instructional Video  
086-12616 \$119.95



JP AR Speed Hammer  
JPSH-1A Low Mass Hammer  
086-12617 \$59.95



JP Enhanced Reliability,  
Reduced Power AR Spring Set  
086-12590 \$10.95



JP Reduced Power  
AR Spring Set  
086-12618 \$10.95

# SPECIAL PURCHASE! SureFire Flash Hider/Suppressor Adapter

The SureFire FH556-212A is a high-performance flash hider for the Colt Commando, C8 SFW, M4, M16, HK416, and 5.56mm (.223 cal.) semi-auto, bolt-action, or assault rifles with Mil-Spec 1/2-28 muzzle threads. It also serves as a precision, rock-solid adapter mount that enables rapid no-tools attachment of SureFire FA556K, FA556-212, FA556MG, or MINI suppressors to the rifles listed above and other rifles with the same muzzle thread/configuration.



086-10884 \$39.99

# HIPERTOUCH® ADAPT. CONTROL. COMMAND.™



The HIPERTOUCH® 24C is the competition version of high precision fire-control drop-ins for installation in AR-15® and AR-10® type rifles.

086-11816 \$235.00



The HIPERTOUCH® 24 3Gun, or 24 3G, is similar to the 24C, but with a curved trigger bow instead of straight, for installation in AR-15® and AR-10® type rifles.

086-11819 \$225.00

# Elftmann Tactical SE Drop-In Trigger



The ELF-SE Drop-In Trigger for mil-spec AR-15s features an extremely short takeup; a clean, crisp break; and a very short, positive reset with a non-adjustable 3.5-lb. pull weight. The total physical weight of the entire trigger unit is 2.3 oz.

086-10007 \$169.00

# C-MORE SYSTEMS



RTS2R



Railway

Built for speed, these High Performance red dot sights will take your shooting ability to the next level. By using a single red dot as an aiming point, target acquisition is as simple as point and shoot. The unique Heads-Up-Display (HUD) design provides an unlimited field of view, while eliminating obstruction and tunnel vision common to tube-style scopes.

<b>C-More Systems RTS2R</b>		<b>C-More Systems Replacement Modules for Railway/Scout Sights</b>	
6 MOA Black	O86-14518	\$419.00	2 MOA Dot Module, Polymer
8 MOA Black	O86-14563	419.00	2 MOA Dot Module, Aluminum
<b>C-More Systems Railway Sight</b>		O86-14620	\$49.00
Polymer 8 MOA Black	O86-16413	\$279.00	4 MOA Dot Module, Polymer
Aluminum 8 MOA Black	O86-14611	329.00	4 MOA Dot Module, Aluminum
<b>C-More Systems Tactical Railway Sight features a built-in spacer to co-witness with sights on flat-top AR-15s</b>		O86-14691	49.00
Polymer 8 MOA Black	O86-16511	\$289.00	4 MOA Dot Module, Aluminum
Aluminum 4 MOA Black	O86-14612	339.00	6 MOA Dot Module, Polymer
			6 MOA Dot Module, Aluminum
			8 MOA Dot Module, Polymer
			8 MOA Dot Module, Aluminum
			Railway/Scout/Tactical Battery
			CR2032 Lithium STS/RTS Battery
			O86-14721 5.00

## J. Dewey Mfg. Co. AR-Link Cleaning Pin



Dewey's AR-Link Cleaning Pin utilizes the rear take-down pin in your AR-15 style rifle to hold the upper and lower receivers open for cleaning. It fits AR-15s and AR-10s with take-down pins up to .316" in diameter. O86-18599 \$14.95

## Emergency AR(eapir) Kit

Crucial Parts for Your AR-15



The Specialized Dynamics AR-15 Emergency Repair Kit includes: three gas rings, extractor spring, firing pin retaining pin, buffer retaining pin/spring, hammer/trigger pin, take down detent and spring. O86-19460 \$19.95

## Tac Latch



The Badger Ordnance Tac Latch makes it much easier for you to operate the latch on your AR-15/AR-10 charging handle. It works especially well for "flat-top" rifles equipped with low-mounted optics. O86-10379 \$18.95

## Jerry Miculek AR-15 Compensator



Jerry Miculek's three-chamber AR-15 Compensator fits threaded-barrel rifles and may be "clocked" for left- or right-handed shooters. Used by many top three-gun competitors. O86-11328 \$49.95



We have a limited supply of these folding AR-15 front sights with tritium inserts. They were made for SIG Sauer. O86-48961 \$49.95



Your basic, generic, strap-on-with-Velcro™ AR-15 brass catcher. O86-15478 \$14.95

# Bushnell Trophy TRS-25 Ultra Compact Red Dot Sight



Bushnell's Trophy TRS-25 Ultra Compact Red Dot Sight is designed for use on shotguns, handguns and rifles. It is constructed and assembled by highly skilled craftsmen to Bushnell's high quality standards. The precision and craftsmanship with which this scope was built ensures its performance under demanding conditions. This scope will provide the shooting accuracy and repeatability which have made Bushnell legendary. Features unlimited eye relief and a three-minute-of-angle dot. TRS-25 as pictured w/o riser O86-11643 \$89.95 TRS-25 with riser O86-31318 \$119.95

## Scout Scope Mounts for AK, SKS Rifles



Sorry, the optic pictured here is NOT included with the Scout Scope Mount.

Scout Scope Mounts provide an extremely stable optics base for your AK, Saiga or SKS rifle and will not shift, vibrate loose or change point of impact as the rifle heats up. Rock solid and easy to install, the two-piece design enables the removal and replacement of your optics without losing zero. Scout Scope Mounts easily allow for complete DISASSEMBLY of your rifle for cleaning and maintenance while retaining zero. These rifles are designed so that carbon build-up can easily be cleaned from the gas tube and piston. This is routine maintenance, necessary in order to maintain a properly functioning rifle. Other mounts for AK-and SKS-style rifles make this difficult, time consuming and then require that optics be re-zeroed. Scout Scope Mount for AK Rifle O86-25374 \$79.99 Scout Scope Mount for SKS Rifle O86-25373 78.99

## Evolution Gun Works Picatinny Rail Scope Mounts



\$39.99

<b>Available in Standard Elevation or Plus-20 Minutes of Angle</b>		
Remington Model 700 Short Action	O86-19975	
Remington Model 700 Short Action + 20 MOA	O86-19976	
Remington Model 700 Long Action	O86-19977	
Remington Model 700 Long Action + 20 MOA	O86-19978	
Ruger 10/22 + 20 MOA	O86-19987	
Savage Short Action RB	O86-19979	
Savage Short Action RB + 20 MOA	O86-19980	
Savage Long Action RB	O86-19981	
Savage Long Action RB + 20 MOA	O86-19982	
Winchester Model 70 STD	O86-19983	
Winchester Model 70 STD + 20 MOA	O86-19984	
Winchester Model 70 Short Action	O86-19985	
Winchester Model 70 Short Action + 20 MOA	O86-19986	

## Tactical Sports 45°-Offset Auxillary Optics Mount



A twist of the wrist is – quite literally – all it takes to switch from your long-range optic to a CQB red-dot sight with Tactical Sports' 45-degree Offset Auxillary Optics Mount! Fits most Picatinny rails. (Pictured with Bushnell's TRS-25, which is NOT included!) 45° Offset Optic Mount O86-14472 \$14.99

## Evolution Gun Works Chamber Checkers



<b>Speed up the round-checking process when you're getting ready for a match!</b>		
EGW uses actual Clymer chamber reamers to produce its chamber checkers.		
<b>Rifle Chamber Checkers</b>		<b>Pistol Chamber Checkers</b>
.223 Rem. O86-25377 \$29.95		9mm O86-19846 \$19.95
5.56x45 O86-25376 29.95		.38 Super O86-19847 19.95
.308 Win. O86-18964 39.95		.40 S&W O86-19848 19.95
.30-06 O86-19675 45.00		10mm O86-19676 20.00
		.45 ACP O86-19849 19.95
		<b>Shotgun Chamber Checker</b>
		12 Ga. O86-19523 \$49.99
		20 Ga. O86-19524 49.99
		<b>Cowboy Chamber Checker</b>
		.357 Mag., .44 Mag., .44-40, .45 Colt O86-25375 \$19.95

# Shootists Holiday 2018



Nepalese Martini

By Peter Caroline

There is a mysterious magnetic phenomenon that occurs once a year in Raton, New Mexico. It attracts virtually every interesting firearm in the country, and is called, for lack of a better name, Shootists Holiday. Otherwise rational individuals spend days driving from all parts of the country to be part of it. My annual pilgrimage follows the same pattern...I drive up to Lakeside, Arizona, to meet up with my old friend Bill, who is my purchasing monitor, i.e., every time I consider purchasing a fascinating old relic, I wait for Bill's opinion. If he refers to it as a POS or a catfish anchor, I buy it. Never fails.

This year, we took Bill's new-for-him Ridgeline up to Raton. Our driving styles differ. I regard a predetermined ETA as holy writ; Bill likes to wander and explore ("Look, a squirrel!"). Despite a lunch stop at the Cracker Barrel in Albuquerque, we still managed to arrive at the Melody Lane motel in Raton only 16 minutes past my goal.

The next day, we held our morning meeting at the Pistol Silhouette Range at the NRA Whittington Center. There were some new rules in place: because of the dry conditions and the ongoing 36,000-acre Ute Park fire west of Cimarron, we were somewhat restricted as to what and where we could shoot, and smoking was verboten, except inside our own vehicles. As I walked up and down the firing line, I was treated to a striking panoply of arms. One recently retired law enforcement officer displayed a mirror-polished stainless Ruger GP100 .44 Special revolver and a beautifully engraved, pearl-handled Smith & Wesson New Departure Safety Hammerless revolver in a velvet-lined case. He also had a rare Walther PP Sport .22, with a long barrel, adjustable sights and an extended grip. We actually got to fire that one...very picky about ammo, but we finally found some that it liked.

There were fancy, engraved guns galore. At Bobby Tyler's table, I spotted a lovely old Colt Pocket Hammerless that had the full refinish and overall engraving treatment, plus a modern Thompson gun, drum magazine included, that had been upgraded with Tyler's own color case-hardened finish. Most impressive! Further up the line was a unique ivory-gripped multi-caliber single-action revolver...six detachable barrels and six cylinders to match, all in a handy carry case. The same craftsman was also displaying an ivory-handled, color casehardened Bisley, with a beautifully etched wolf portrait scrimshawed on the ivory buttplate.

Taking a break from this surfeit of unobtainium, Bill and I drove over to the Sighting-in Range, to make sure that our rifles had maintained their zero on the ride up. I had a recently acquired Browning BL-22 "Boys Rifle" with a 16-1/4" barrel and a Bushnell Banner 4x scope. It shot to point of aim with no adjustment. My Ruger Precision Rimfire Rifle, with Konus 3-10X scope and KDM Hugin

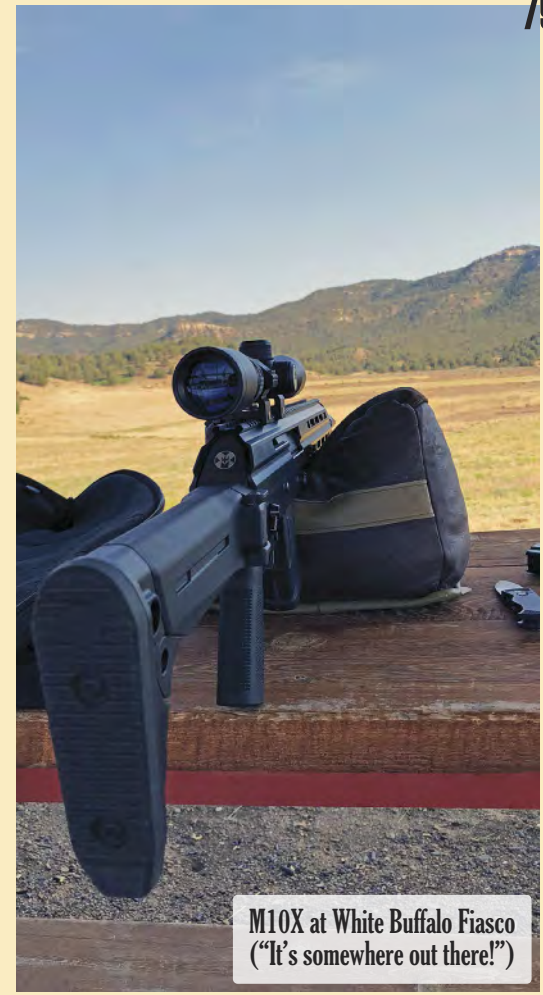

M10X at White Buffalo Fiasco ("It's somewhere out there!")



M10X Sight-in

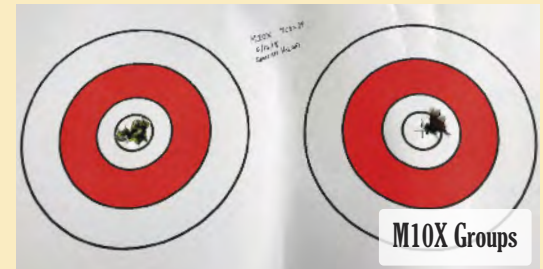

M10X Groups





Polished stainless Ruger GP100 .44

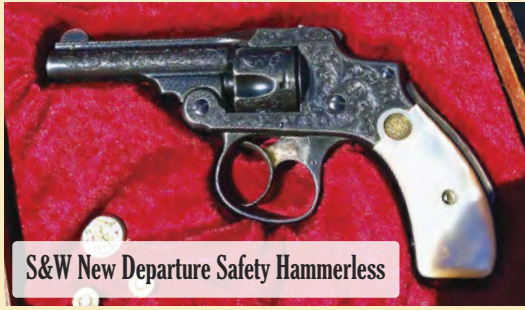

S&W New Departure Safety Hammerless



Walther PP Target Model



Colt Pocket Hammerless



Wolf Scrimshaw

.22 LR suppressor, needed only a slight adjustment. The big surprise was the M+M Inc. M10X. This semiautomatic carbine, which was reviewed in *The Blue Press* earlier this year by Oleg Volk, is chambered in 7.62x39mm. At first glance, it looks like an AK-47, albeit one built for civilized human beings, but it also incorporates features of the FAL and AR. With a 3-9x Barska scope, unlike most of its 7.62x39 semiauto brethren, it shoots tiny little 5-shot groups with great regularity.

Ogling other people's treasures and shooting my own and other people's guns is great fun, but finding and acquiring new toys is even more delightful, so Bill and I found our way to the NRA gift shop. While he bought mass quantities of chocolate and kept the gift shop staff entertained, I checked out the 3-ring binder that listed the Secret Attic's current stash of used inventory. Skimming through the preponderance of GLOCKS and other polycarbonate detritus, I found one fascinating gem...something described as a 1912 Steyr. Many years earlier, I had owned a 1912 Steyr. It was a semiautomatic pistol, chambered for a long-forgotten 9mm cartridge, and fed from a stripper clip into a built-in magazine. The 1912 Steyr listed in the 3-ring binder was listed as a .308, a modern rifle cartridge. Could this be a mistake? I requested a peek at this puzzle, and it was brought downstairs for my inspection. It was indeed a rifle, a basic early K98k Mauser pattern, built for the Chilean military by Steyr in Austria, and rebarreled in .308 in 1961. It bore the Chilean crest and "MODELO 1912-61 NATO on the receiver ring. The wood was sound, albeit heavily dinged, and the bore was mirror bright. Trigger pull was typical military two-stage 6-1/2 pounds. Bill said, "That's not a catfish anchor, it's a shark anchor!" So I had no choice but to buy it.

Situated next to the gift shop is the Whittington Center's NRA Museum, featuring a mind-numbing array of historic and custom guns, both American and imported. You would have to spend at least a day to fully take in all these exhibits. Next year, maybe I will.

Over the next several days, I shot a number of other people's guns. The most entertaining, how-



Multi-caliber Single Action

ever, was an 1880s Nepalese "Gahendra" Martini Henry military rifle in .450/.577 caliber. This was the "long-lever" version. Someone stated, quite accurately, that anyone who fired this gun and didn't end up laughing had no soul. Absolutely right on; the loud boom and long, slow recoil were a rare delight. Did anyone hit anything? Who knows?

One of the highlights of the Whittington Center experience is the high power rifle silhouette range, which features the fabled White Buffalo. This is a 6'x10' white painted steel target with a 16" black aiming point. The target is located 1,123 yards from the firing point...nearly 2/3 of a mile. It might as well have been on the freakin' moon. Bill shot at it with his iron-sighted .30-30. I shot at it with my M10X. Nothing, nichts, nada, nichevo. We were about to give up when one of our fellow Shootists showed up with his 9-year old son and an impressively scoped 6.5 Creedmoor rifle. They both shot...one shot each, and both shots were rewarded with a distant "clang." They let us try the rifle, and both Bill and I both hit with our first shot. Apparently, we had previously been shooting at the wrong target. Dumb and dumber. But we have good table manners, so they let us hang with the cool kids.

As usual, we ate well. Tequila's Mexican restaurant is just up the road a piece in Trinidad, Colorado, and features the best Mexican food I've ever enjoyed. Despite the earlier danger from the Ute Park fire, Cimarron emerged unscathed, and at the St. James Hotel, I was treated to the absolute best ribeye in the western hemisphere, black on the outside, blue rare on the inside, and marvelously tender. Raton's old Ice House restaurant is once again open for business, and they serve a half-pound hamburger to die for. Like MacArthur, I shall return.

DP



Steyr 1912-61 .308 "Shark Anchor"



Ornate Mauser Broomhandle @ NRA Museum



Colt Delta Elite @ Museum



S&W 66-1 @ Museum



Browning BL-22 Sight-in



**"Firestorm in the Desert (Machine Gun Magic)"** – Dillon's own video portraying the history and excitement of the machine gun hobby. 60+ min.  
**"Machine Gun Magic"** DVD format **O86-18312 \$14.95**  
**"The Memphis Belle"/"The Fight for the Sky"**  
 Two-DVD Set **O86-18320 \$24.95**

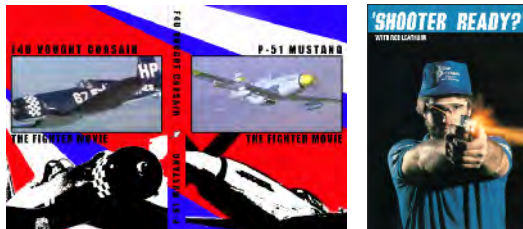

**"Shooter Ready?"** – Top quality instruction with all the excitement of a major motion picture. 30 min. VHS format **O86-13361 \$15.95**  
**"Shooter Ready?"** DVD format **O86-18313 \$14.95**  
**"P51 Mustang"/"Corsair"**  
 Two-DVD Set **O86-18321 \$24.95**

**WARNING:** The products offered for sale in this catalog can expose you to chemicals, including BPA's, which are known to the State of California to cause cancer, birth defects or other reproductive harm. For more information, go to [www.P65Warnings.ca.gov](http://www.P65Warnings.ca.gov).



**Lyman 50th Edition Reloading Handbook** – Featuring More Loads, the Newest Components, Most Manufacturers, and More Load Data than Ever!  
**O86-10330 \$24.95**

**NEW! Lyman Long Range Precision Rifle Reloading Handbook**  
**O86-10207 \$16.98**

**Lyman's Pistol and Revolver Reloading Handbook (Third Edition)** – The World's Leading Handgun Reloading Manual.  
**O86-18967 \$21.95**



**Lyman's AR Reloading Handbook** – Featuring loads for your AR chambered in popular cartridges from the .204 Ruger to the .50 Beowulf.  
**O86-10976 \$12.99**

**Lyman Shotshell Reloading Handbook, 5th Edition** – The Number One Shotshell Loading Manual.  
**O86-12846 \$25.95**

**The Complete Reloading Manual for...**

Pretty much anything you're likely to be loading! That's right, all the data published by the various bullet and powder manufacturers for YOUR favorite cartridge. **\$9.95 each**

- .32 H&R Magnum
- .380 ACP
- 9mm
- .38 ACP
- .38 Special
- .357 Magnum
- 10mm/.40 S&W
- .44 Special
- .44 Magnum
- .45 ACP
- .45 Colt
- .223
- .22-250
- .243
- .270
- 7mm-08
- 7mm Remington Magnum
- 7.62 x 39
- .30 M1
- .30-30
- .308
- .30-06
- .300 Winchester Magnum
- .45-70



- O86-15361**
- O86-15362**
- O86-15363**
- O86-15365**
- O86-15364**
- O86-15366**
- O86-15367**
- O86-15368**
- O86-15369**
- O86-15370**
- O86-15371**
- O86-15349**
- O86-15348**
- O86-15350**
- O86-15351**
- O86-15352**
- O86-15353**
- O86-15359**
- O86-15354**
- O86-15355**
- O86-15356**
- O86-15357**
- O86-15358**
- O86-15360**

**Competition Reloading with Brian Enos**

guides you through a complete step-by-step reloading process for IPSC, Steel Challenge and NRA Bianchi Cup style shooting. Using a Dillon Precision XL 650 reloader, Enos demonstrates proper reloading techniques for the most popular loads used by the top shooters. Enos is, of course, a champion himself, winner of the Masters Competition, the NRA Bianchi Cup and a top contender in the USPSA for many years. Video run time: 80 minutes.  
**O86-14341 \$19.95**



**Gun-Guides**  
 Complete guides for all models of Ruger .22 pistols, 10/22 rifles and Mini-14s; and dis-/reassembly guides for other popular firearms.  
**The Complete Guide \$11.99 each**  
**O86-40035**  
**O86-40036**  
**O86-40037**  
**Dis-/Reassembly Only \$6.99 each**  
**O86-40045**  
**O86-40038**  
**O86-40039**  
**O86-40040**  
**O86-40041**  
**O86-40042**  
**O86-40043**  
**O86-40044**  
**O86-40046**  
**O86-40047**  
**O86-40048**  
**O86-40049**  
**O86-40050**  
**O86-40051**  
**O86-40052**  
**O86-43230**  
**O86-40061**  
**O86-40053**  
**O86-40054**

- 1911 Pistols**
- AK-47**
- Browning Buckmark**
- Colt AR-15**
- GLOCK Pistols**
- M1 Carbine**
- M1 Garand**
- Mauser Rifles**
- Mosin-Nagant Rifles**
- Mossberg 500 Shotguns**
- Remington 870 Shotguns**
- Remington 1100 Shotguns**
- Ruger Mk III Series .22 Pistols**
- Ruger Single-Action Revolvers**
- SKS Rifles**
- S&W M&P/Shield Pistols**
- 1903 Springfield Rifles**
- Springfield XD & XDM Pistols**
- Winchester 1300 Shotguns**

**Traveler's Guide to the Firearm Laws of the Fifty States** – The myriad of firearm laws facing the gun owner of the early 21st Century can be intimidating when traveling.  
**O86-30201 \$14.95**

**Practical Shooting: Beyond Fundamentals** – The keys to consistent, high-speed shooting are within you right now. This book will show you ways to bring them out.  
**O86-10750 \$19.95**



John Marshall's book **101 Classic Firearms: A Chronological Foray into the Golden Years of Firearms Development**, is a compilation of the author's popular articles appearing in *The Blue Press* since 2007. **101 Classic Firearms** is sure to be a prized addition to the library of any serious firearms enthusiast.



Published by Dillon Precision, and printed and bound in the USA, **101 Classic Firearms** is a high-quality full color 11.5" x 9" hardcover with 224 pages packed full of insights and history on some of the



**O86-40133 \$29.95**

world's most important firearms. About the Author: John Marshall is an accomplished photographer and freelance writer whose articles have appeared in *The Blue Press*, *Gun Digest*, *Guns & Ammo's Handguns*, and *American Gunsmith*. An expert on firearms, he is also a member of the Remington Society of America, the Smith & Wesson Collectors Association, the Smith & Wesson Historical Foundation and the American Gunsmithing Association. John is also an endowment member of the National Rifle Association.

**EMPTY Surplus Ammo Cans/Crates**



**WARNING:** This product can expose you to chemicals, including Formaldehyde, which are known to the State of California to cause cancer, birth defects or other reproductive harm. For more information, go to [www.P65Warnings.ca.gov](http://www.P65Warnings.ca.gov).



**.30-CAL.-SIZE AMMO CANS, 4-PK.**  
**O86-11349 \$31.95**



**Kershaw Knives** and **Emerson Knives** have joined forces on a series of knives that combine the precision engineering of Kershaw with Emerson's uncompromising functional design. The CQC-6K features a modified clip-point blade for versatile cutting ability. The blade has two finishes: a satin finish on the upper and a stonewashed finish on the grind. The handle's front scale of textured G-10 offers a secure grip and the handle's stainless steel back has a solid frame lock.

The CQC-6K is a manual opener using either the thumb disk or the patented Emerson "wave shaped feature." This opening feature enables the knife to be opened as it is removed from the pocket. The pocketclip is reversible for left- or right-handed carry.  
 Blade length: 3.25" Closed: 4.5" Open: 7.75"  
**O86-31320 \$54.99**



Designed by Belarusian custom knifemaker Dmitry Sinkevich, the new **Kershaw Pub** looks like nothing you've ever seen. Closed, you'd never know there was a handy blade inside – although you would definitely see the equally handy bottle opener. And if you were exceptionally sharp-eyed, you might notice the slotted screwdriver tip right next to the bottle opener. To reveal the blade, just push down on what looks like the key ring attachment. You'll see the blade move out of the compact handle. Keep pushing and the blade will swing all the way out, ready for use. The blade is a modified sheepfoot with a straight edge and clipped rather than rounded tip. The handle has an anodized aluminum front scale in bright blue and a steel back.  
 Blade length: 1.6" Closed: 3.1" Open: 4.5"  
**O86-31323 \$24.95**

# 84 Wise Company's "Grab & Go" Emergency Food Kits

Wise Company's **18 Wise Favorites 72-Hour Kit** includes six entrées and three breakfast meals, each individually packaged for a total of 18 servings (2 servings per pouch). Entrées include meat. Packages included have a shelf life of 7 years compared to those in our buckets with a shelf life of 25 years. Great for hunting, camping and hiking! Simple to prepare, just add boiling water directly into pouch.



**\$49.99**  
086-27069

Wise Company's **60 Serving Gourmet Entrée Only "Grab and Go" Food Kit** includes two servings per day (entrées only) for one adult for one month or four adults for one week. **Product within this Bucket is:** Savory Stroganoff (8 servings), Chili Macaroni (8 servings), Pasta Alfredo (8 servings), Creamy Pasta and Vegetable Rotini (8 servings), Cheesy Lasagna (4 servings), Teriyaki and Rice (8 servings), Creamy Ala King and Rice (8 servings), and Creamy Tomato Basil Soup (8 servings).



**\$119.95**  
086-15297

Wise Company's **60 Serving Gourmet Freeze Dried Meat "Grab & Go" Food Kit** includes 60 servings of assorted gourmet-seasoned freeze dried meat and a 20-serving bonus of long-term emergency rice, for a total of 80 servings. **Product within this Bucket is:** Roasted Chicken (12 servings), Teriyaki Style Chicken (8 servings), Cheesy Beef (8 servings), Southwest Style Chicken (12 servings), Savory Roasted Ground Beef (12 servings), Stroganoff Style Beef (8 servings), and Long-Term Instant Rice (20 servings).



**\$129.99**  
086-15298

Wise Company's **120 Serving Breakfast Only "Grab & Go" Food Kit** includes 120 servings of breakfast assortment (no entrées). **Product within this Bucket is:** Apple Cinnamon Cereal (40 Servings), Crunchy Granola (40 Servings), and Brown Sugar and Maple Multi-Grain (40 Servings).



**\$199.00**  
086-15303

Wise Company's **120 Serving Freeze Dried Vegetable and Sauce "Grab & Go" Food Kit** includes 120 servings of vegetable and sauce assortment. **Product within this Bucket is:** Corn (24 servings), Peas (16 servings), Broccoli (24 servings), Green Beans (24 servings), Butter Sauce (8 servings), Cream Sauce (8 servings), Cheese Sauce (8 servings), and Mushroom Sauce (8 Servings).



**\$134.99**  
086-15302

Wise Company's **120 Serving Freeze Dried Fruit and Snack "Grab & Go" Food Kit** includes 120 servings of fruit and snack assortment. **Product within this Bucket is:** Bananas (16 servings), Strawberries (16 servings), Peaches (16 servings), Apples (16 servings), Caramel Sauce (16 servings), Yogurt (16 servings), and Pudding (16 Servings).



**\$144.99**  
086-15300

# Individual First Aid Kits From The Tactical Medic

Nobody likes to think about it, but should a serious hunting/shooting accident occur, chances are the drugstore "first aid kit" you have stashed under the seat of your truck won't do much good. That's why we're offering individual first aid kits from The Tactical Medic. The Econo-IFAK contains a 4" Emergency Bandage, a TK-4 Combat Tourniquet, 1 Package of Rolled Gauze, 1 Roll of Medic's Tape and 1 Pair of Nitrile Gloves. The Micro Kit #2 contains a 4" Pressure Bandage, 1 Package of Quick Clot Gauze, a TK-4 Combat Tourniquet, 1 Roll of Medic's Tape and 1 Pair of Nitrile Gloves.



Econo-IFAK (at right in photo) **086-43379 \$15.00**  
Micro Kit #2 (at left in photo) **086-43378 30.00**

# COMPETITIVE EDGE DYNAMICS 85



**CED M2 Chronograph**  
086-17926 \$199.00



**CED7000 Timer**  
086-19208 \$119.95

## M2 Chronograph Accessories

- Infrared Chronograph Upgrade Kit **086-12116 \$89.00**
- Rechargeable Batt. Pack for Above **086-12117 48.00**
- Nylon Carrying Case **086-18145 35.95**
- Tripod **086-18126 42.95**
- 2-Ft. Skyscreen Mounting Bracket **086-18120 14.95**
- Replacement Skyscreens **086-18124 21.95**
- Replacement M2 Sensor **086-18877 36.95**

The M2 Chronograph comes with sensors, screens and one two-foot mounting bracket. A nylon carrying case and tripod are available options. The CED7000 Shot Timer is a breakthrough in technology. No other timer to date offers this combination of advanced features, compact size and light weight. This is the "next generation" Shot Timer here today! Comes with a rechargeable battery with low-battery LCD indicator and a universal charger.

## Adjustable Target Pistol Sight



This Adjustable Target Pistol Sight is precision machined and fits in a standard 1911 "Bomar slide cut." Yeah, the services of a gunsmith are required to cut the slide (unless your pistol already has a Bomar cut) but the results are worth it.

**086-18210 \$53.95**

## Evolution Gun Works 1911 Magwell



EGW 1911 Magwell, Blue **086-18601 \$74.99**  
EGW 1911 Magwell, Stainless **086-18600 74.99**

# D-TERMINATOR Electronic Scale



- 1500 grain/100 gram capacity
- Accurate to 0.1 grain/0.01 gram
- Uses four AA batteries (included)
- Comes with its own AC adapter
- 100g scale check weight included

**\$139.95**  
086-10483

*All the electrical/electronic components of Dillon equipment are covered by a one-year warranty from date of purchase.*

## Dillon's "Eliminator" Balance Beam Scale



**\$89.95**  
086-13480

### GED Ultimate Pro Powder Trickler



- Adjustable height
- Weighted base
- Extension arm

**\$21.95**  
086-10940

### Lyman Powder Pal Funnel Pan



086-18399 \$5.95



Lyman Scale Weight Check Sets enable you to check/calibrate your scale using known weights.

- A. Weight Set .5 - 60.5 Gr. 086-15958 \$36.95
- B. Weight Set .5 - 210.5 Gr. 086-15959 48.95

**WARNING:** The products offered for sale in this catalog can expose you to chemicals, including Lead, which are known to the State of California to cause cancer, birth defects or other reproductive harm. For more information, go to [www.P65Warnings.ca.gov](http://www.P65Warnings.ca.gov).



# QB-D

**QUICK BREAK-DOWN STOCK**  
**CONVERTS STANDARD RUGER® 10/22®**  
**CARBINE MODELS (NOT TAKEDOWN)**  
**INTO A QUICK BREAK-DOWN DESIGN**



- ▮ Patent Pending, Lever-Toggle V-Block Clamp Facilitates Rapid Barrel Removal, Including .920 Diameter Bull Barrels
- ▮ Aluminum Bed Block For Superior Accuracy
- ▮ Precision Folding Mechanism Eliminates Play In Buttstock
- ▮ Buttstock Integrated Barrel Storage Accommodates Both Standard & .920 Bull Barrels

PART # AAQBD MSRP \$ 179.99 **AVAILABLE SPRING 2018**



**NEXT GENERATION AMERICAN INNOVATION**  
 ARCHANGELMANUFACTURING.COM | 800.438.2547

# 2019

## Dillon Precision Calendar



086-44508 \$12.95

**Mr. Bulletfeeder<sup>®</sup>**  
by Double-Alpha  
Automatic Bullet  
Collator/Feeder  
*See Page 33*



**Outers**  
**51-Piece**  
Screwdriver Kit  
*See Page 46*



**KNS Precision, Inc.**  
AK Adjustable Gas Piston System

*See Page 72*



**SureFire**  
Flash Hider/  
Suppressor Adapter  
*See Page 75*

**Surplus**  
**(Empty)**  
**.30 Caliber**  
**Ammo Cans**  
*See Page 83*



### **DILLON PHONE NUMBERS**

**Orders/Expert Assistance: 800-223-4570**  
For orders and technical assistance.

**Order Status/Basic Orders: 800-762-3845**  
Order by stock numbers only  
(no technical questions please);  
or to quickly check the status of your order.

**Catalog Request: 800-762-3844**  
To order *The Blue Press* catalog.

**Dillon Showroom Hours: M-F, 9a-6p; Sat., 8a-3p**

PSRST STD  
U.S. Postage  
**PAID**  
Dillon Precision

**The BLUE PRESS**  
Dillon Precision Products, Inc.  
8009 E. Dillon's Way  
Scottsdale, AZ 85260-1809



Scan QR Code to  
Shop on Our Site.

